



US00D460848S

(12) **United States Design Patent**  
**Tzeng**

(10) **Patent No.:** **US D460,848 S**

(45) **Date of Patent:** **\*\* Jul. 23, 2002**

(54) **CART**

(76) **Inventor:** **Ren-Ju Tzeng**, No. 71 Chien Ping Road, Sec. 2, Jao Ping Tsun, Tenwet Hsiang, Changhua Hsien (TW)

(\*\*) **Term:** **14 Years**

(21) **Appl. No.:** **29/144,465**

(22) **Filed:** **Jul. 5, 2001**

(51) **LOC (7) Cl.** ..... **12-02**

(52) **U.S. Cl.** ..... **D34/21**

(58) **Field of Search** ..... D34/12-27; 280/79.11, 280/79.2, 79.3, 47.19, 47.35; 211/126, 133, 150, 181; D6/465

(56) **References Cited**

**U.S. PATENT DOCUMENTS**

D303,444 S \* 9/1989 Yoshikawa ..... D34/21

D341,459 S \* 11/1993 Yang ..... D34/21

D411,045 S \* 6/1999 Morandi ..... D34/21

D436,239 S \* 1/2001 Walsh ..... D34/21

\* cited by examiner

*Primary Examiner*—Kay H. Chin

(74) *Attorney, Agent, or Firm*—Rabin & Berdo, P.C.

(57) **CLAIM**

The ornamental design for a cart, as shown and described.

**DESCRIPTION**

FIG. 1 is a front view of a cart showing my new design;

FIG. 2 is a rear view thereof;

FIG. 3 is a left side view thereof;

FIG. 4 is a right side view thereof;

FIG. 5 is a top view thereof;

FIG. 6 is a bottom view thereof; and,

FIG. 7 is a perspective view thereof.

**1 Claim, 7 Drawing Sheets**

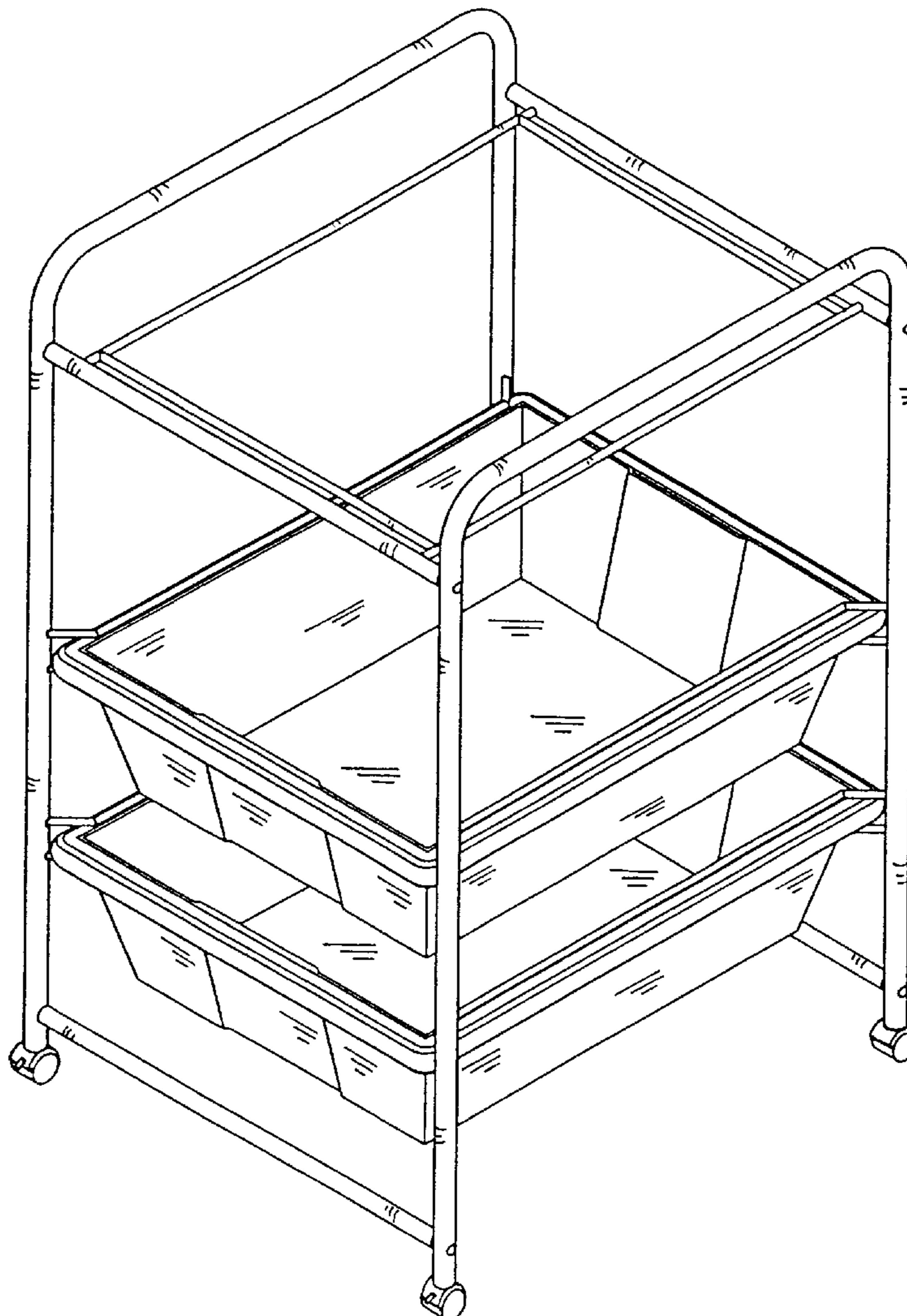

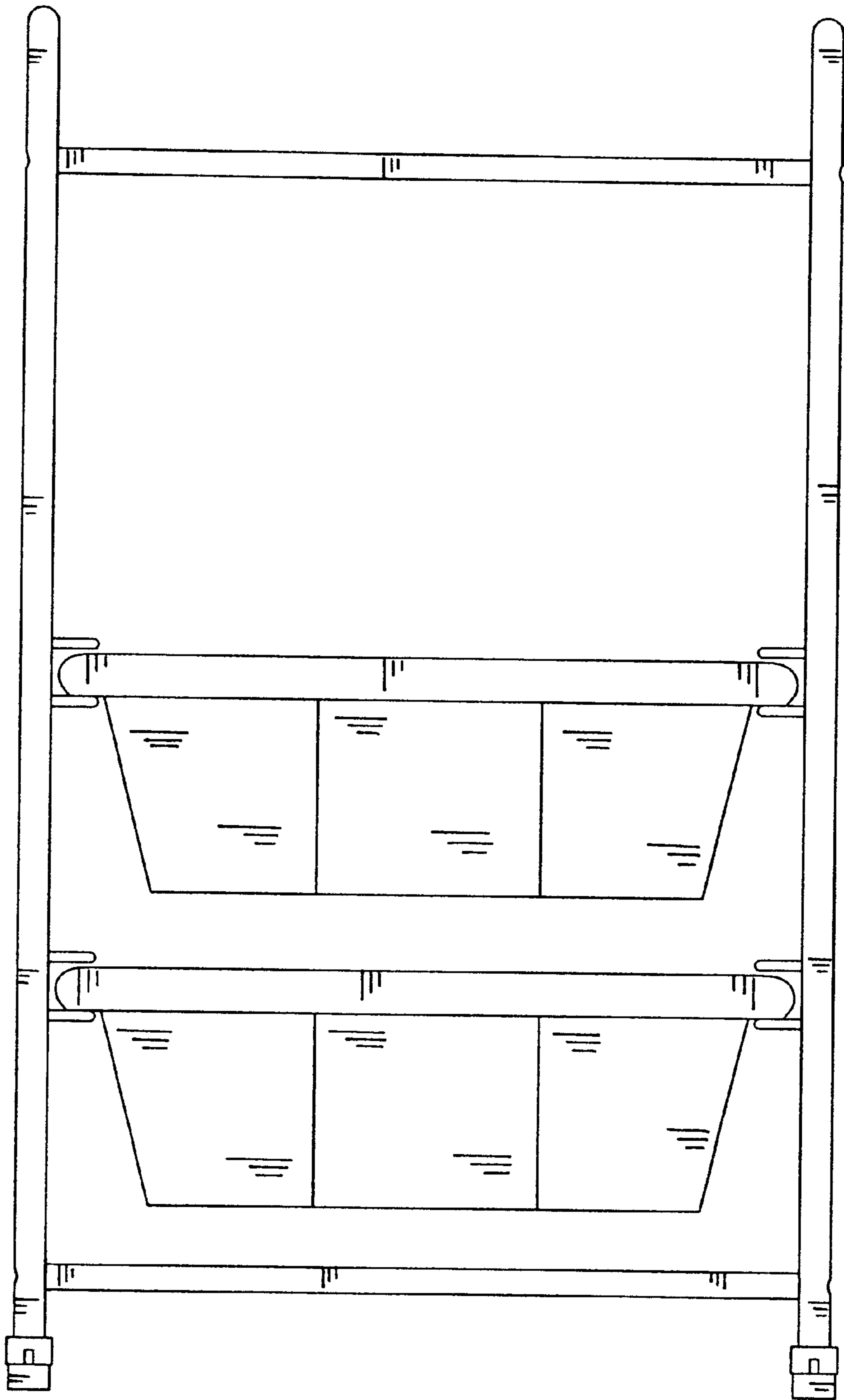

FIG. 1

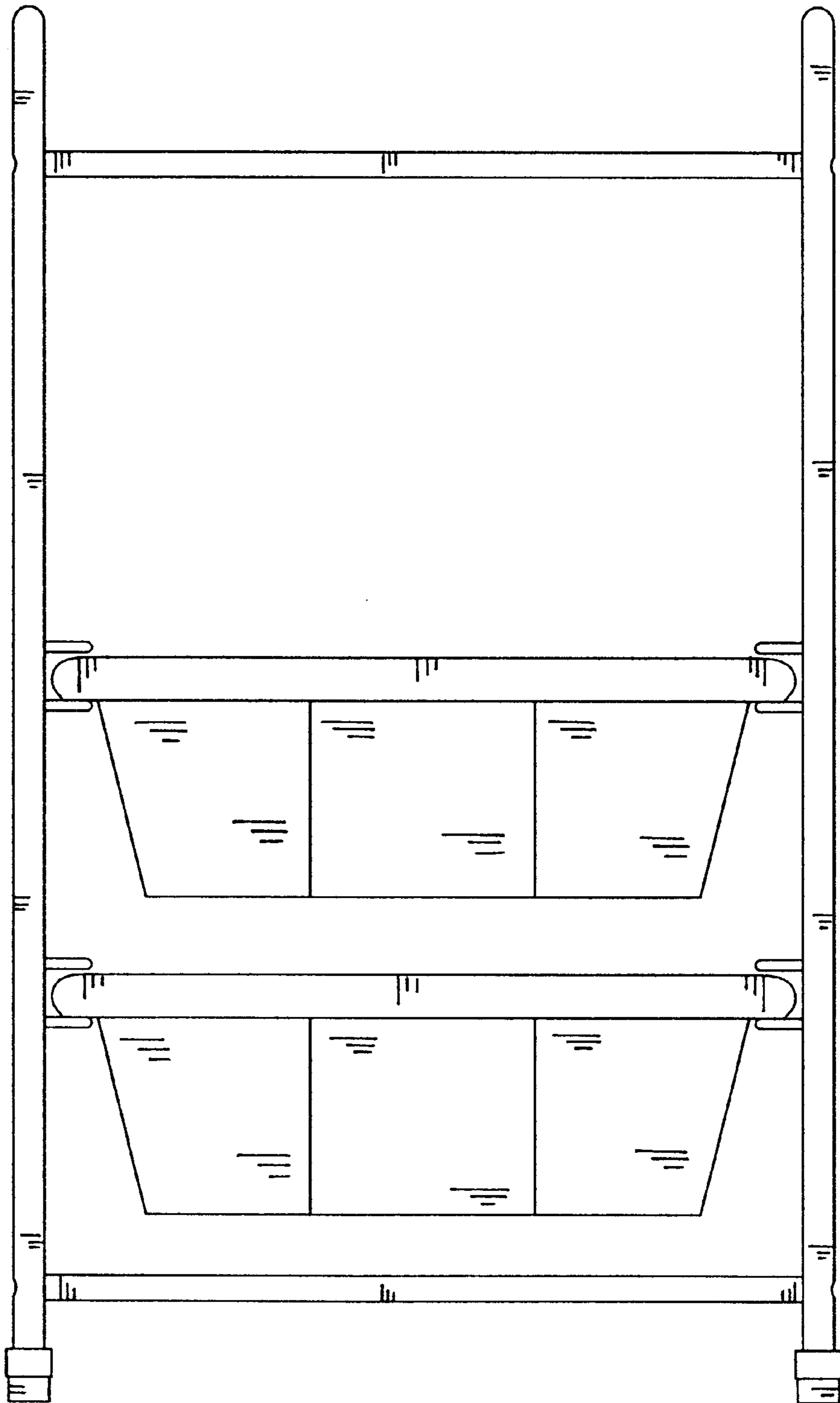

FIG.2

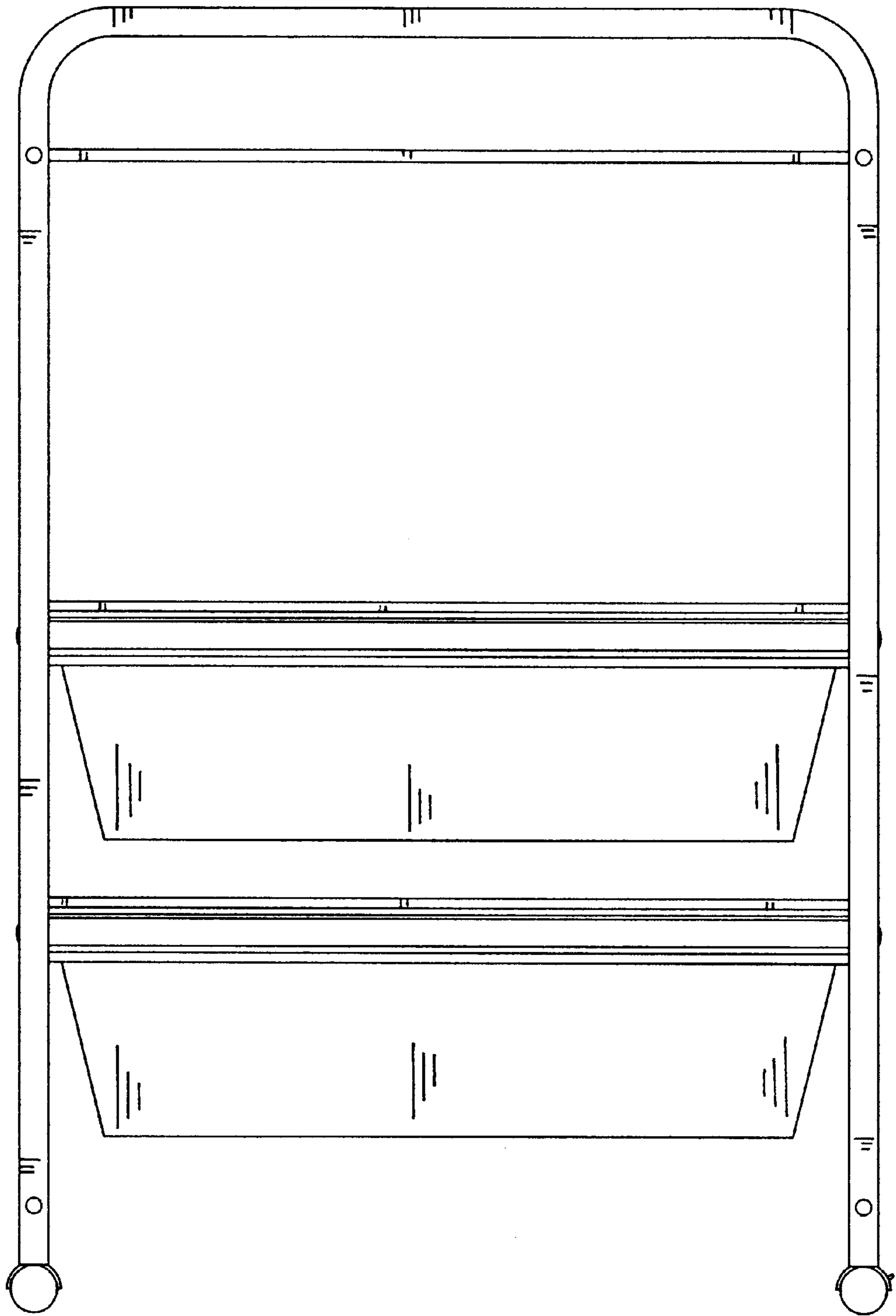

FIG.3

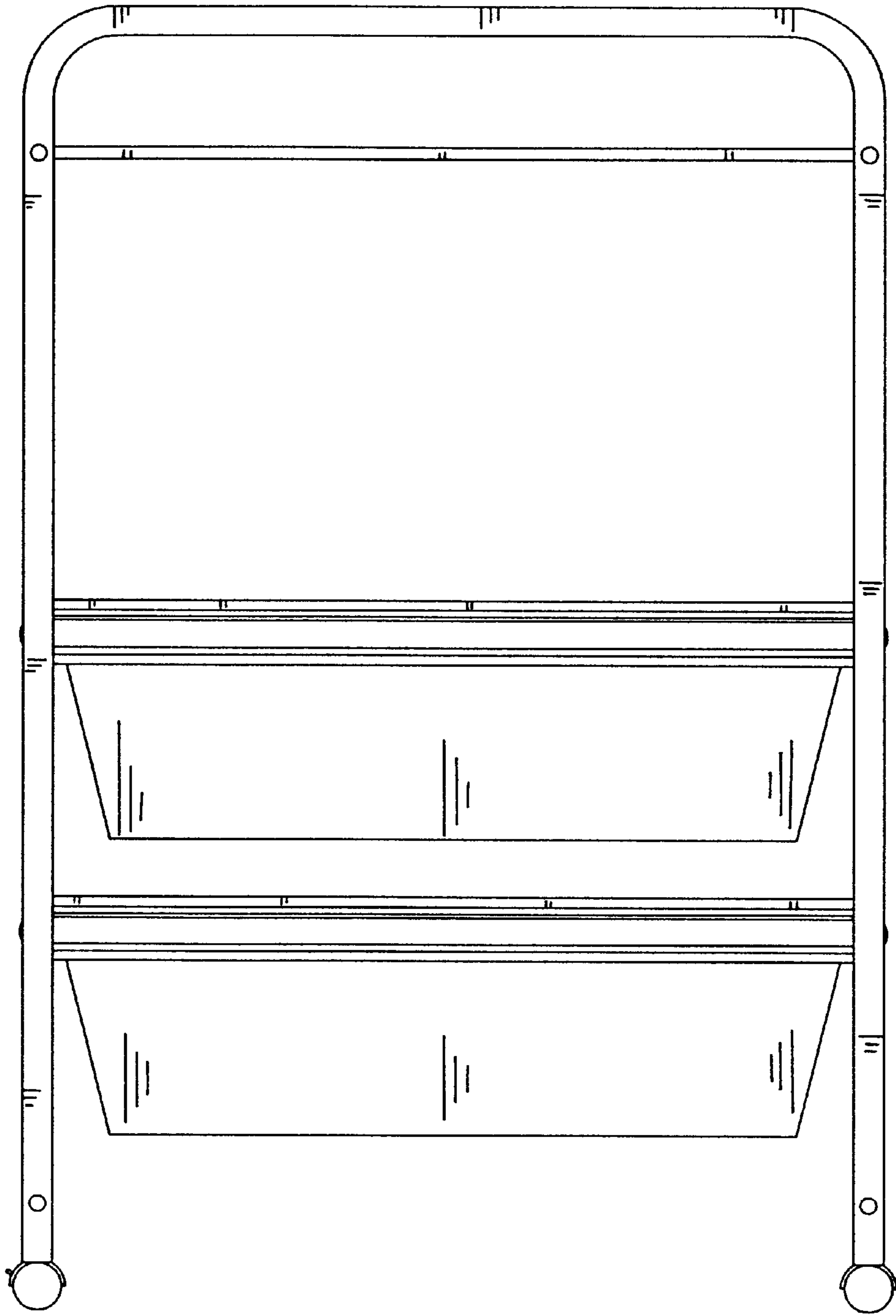

FIG. 4

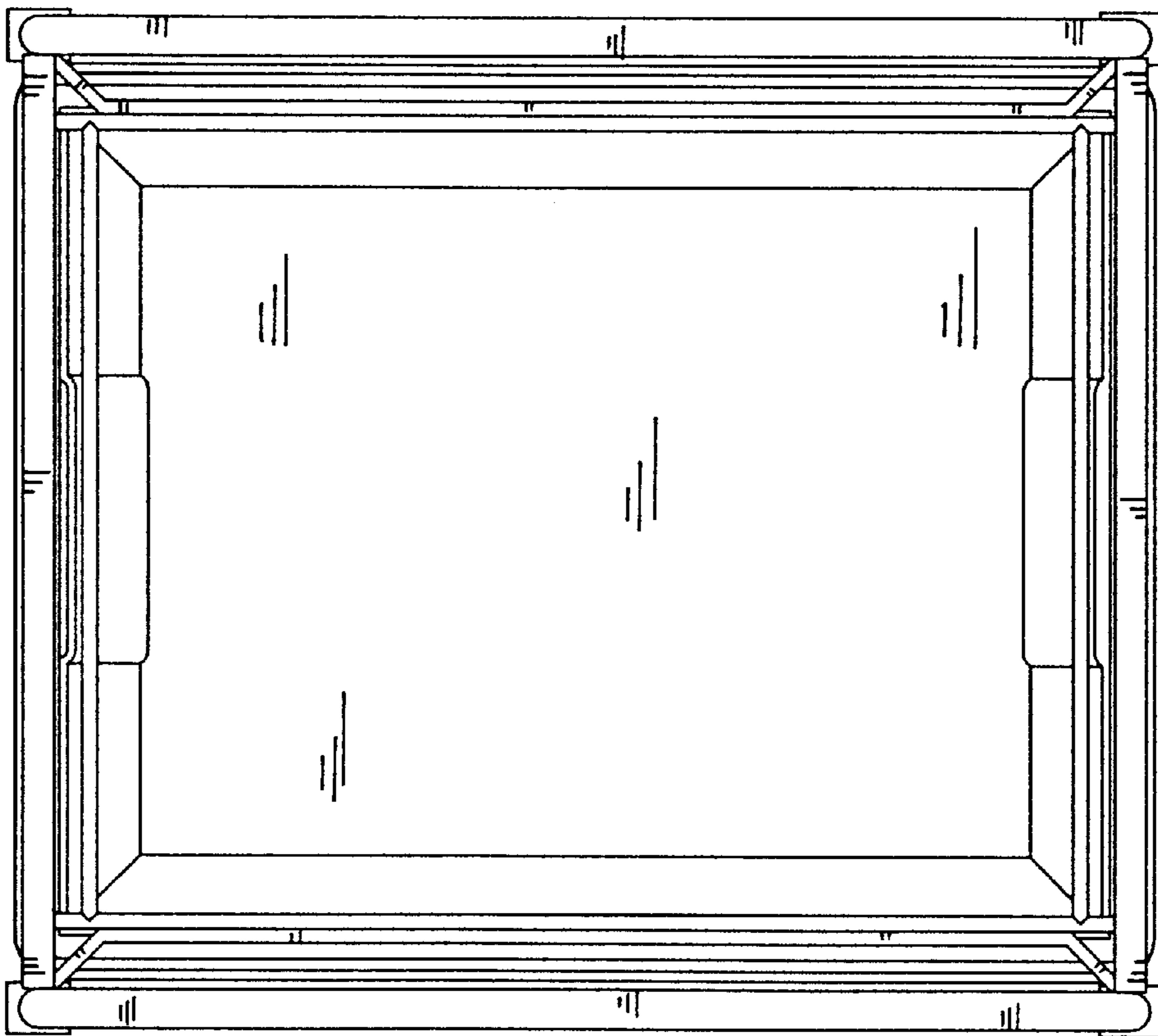

FIG. 5

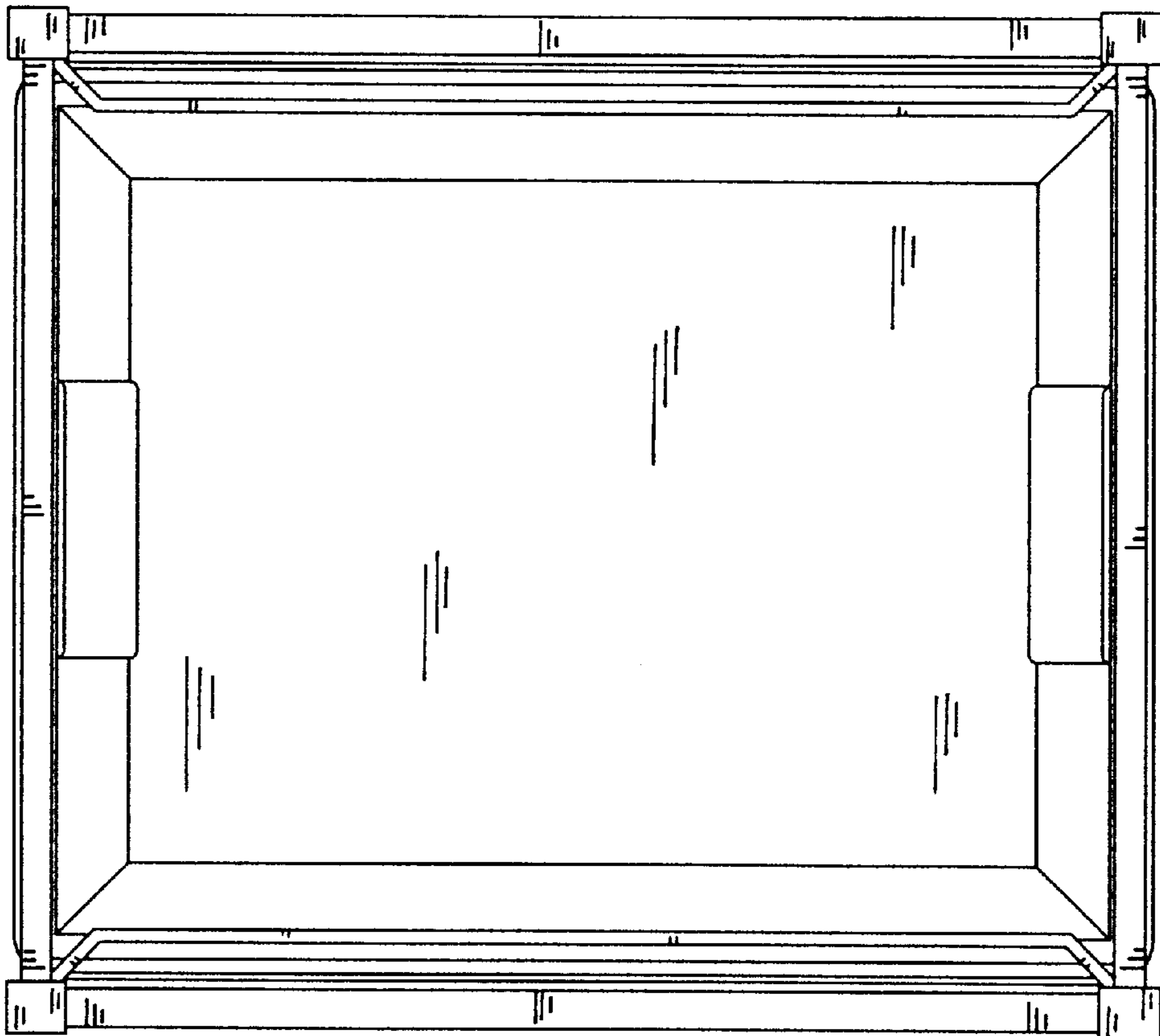

FIG. 6

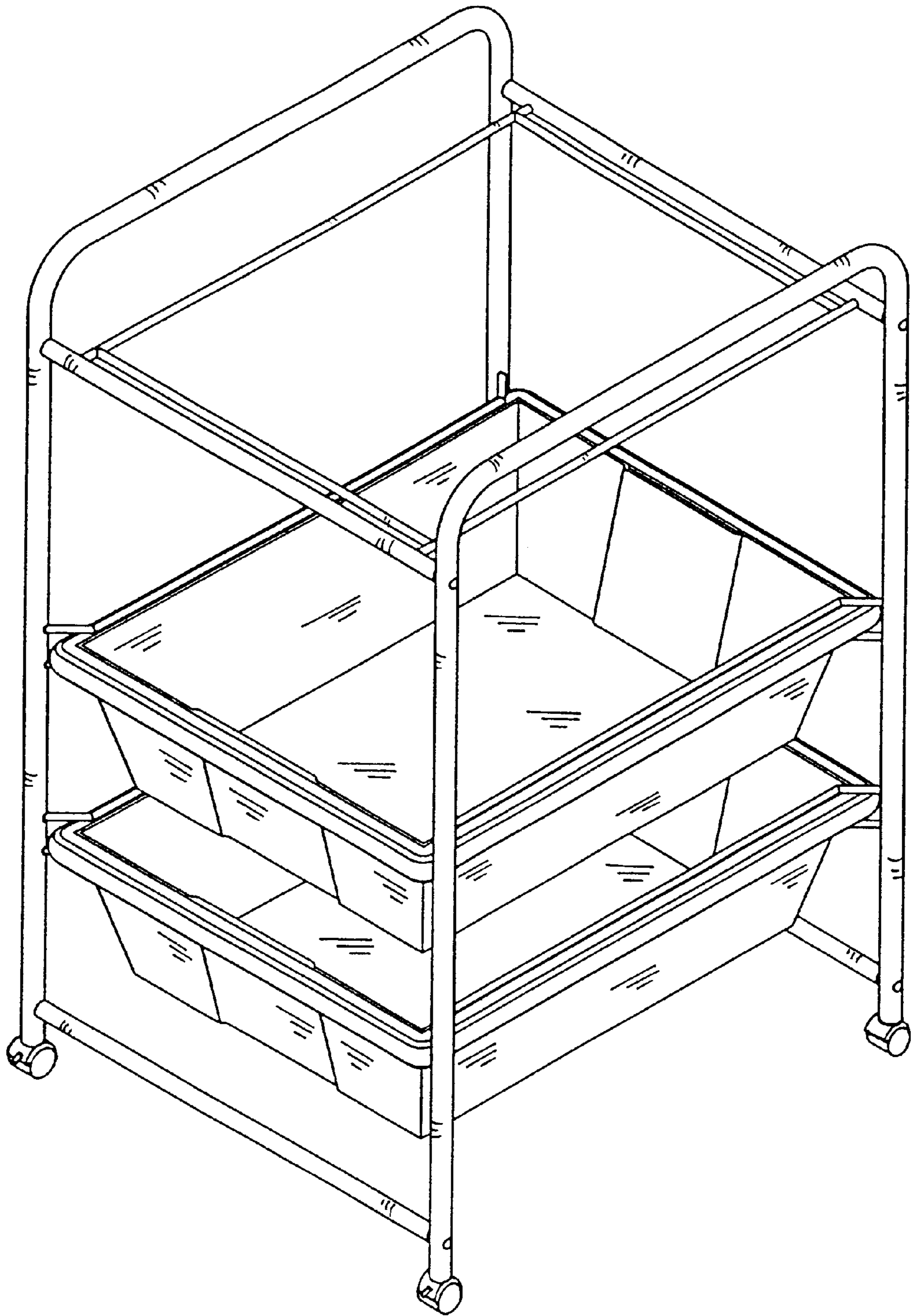

FIG. 7