



US00D460757S

(12) **United States Design Patent**
Keung Li

(10) **Patent No.:** **US D460,757 S**

(45) **Date of Patent:** **** Jul. 23, 2002**

(54) **ELECTRONIC INTERNET ORGANIZER**

(76) **Inventor:** **Robert Shu Keung Li**, 1455 Monterey Pass Rd., Suite 102, Monterey Park, CA (US) 91754

(**) **Term:** **14 Years**

(21) **Appl. No.:** **29/136,423**

(22) **Filed:** **Jan. 31, 2001**

(51) **LOC (7) Cl.** **14-02**

(52) **U.S. Cl.** **D14/345**

(58) **Field of Search** D14/341, 345; D18/1, 2, 7, 6, 11; 235/145 A, 145 R; 341/22, 23; 345/156, 168, 169, 172, 173, 87; 349/12; 361/680-686

(56) **References Cited**

U.S. PATENT DOCUMENTS

D365,839 S	*	1/1996	Kurabuti et al.	D14/345
D428,414 S	*	7/2000	Okumura	D14/345
D430,872 S	*	9/2000	Tamaki et al.	D14/345
D435,550 S	*	12/2000	Chu et al.	D14/345
D436,592 S	*	1/2001	Okumura	D14/345

* cited by examiner

Primary Examiner—Freda Nunn

(57) **CLAIM**

The ornamental design for an electronic internet organizer, as shown and described.

DESCRIPTION

FIG. 1 is a top plan view of an electronic internet organizer in a closed position showing my new design; FIG. 2 is a right side elevational view thereof; FIG. 3 is a front elevational view thereof; FIG. 4 is a left side elevational view thereof; FIG. 5 is a rear elevational view thereof; FIG. 6 is a bottom plan view thereof; FIG. 7 is a perspective view of FIG. 1 thereof; FIG. 8 is a top plan view of the electronic internet organizer in an opened position; FIG. 9 is a right side elevational view thereof; FIG. 10 is a front elevational view thereof; FIG. 11 is a left side elevational view thereof; FIG. 12 is a rear elevational view thereof; FIG. 13 is a bottom plan view thereof; FIG. 14 is a perspective view of FIG. 8 thereof; and, FIG. 15 is a perspective view of FIG. 13 thereof.

The broken lines showing numerals, lettering, and symbols in the key-pad area in FIG. 1, FIG. 7, FIG. 8, and FIG. 14 are for illustrative purposes only and form no part of the claimed design.

1 Claim, 4 Drawing Sheets

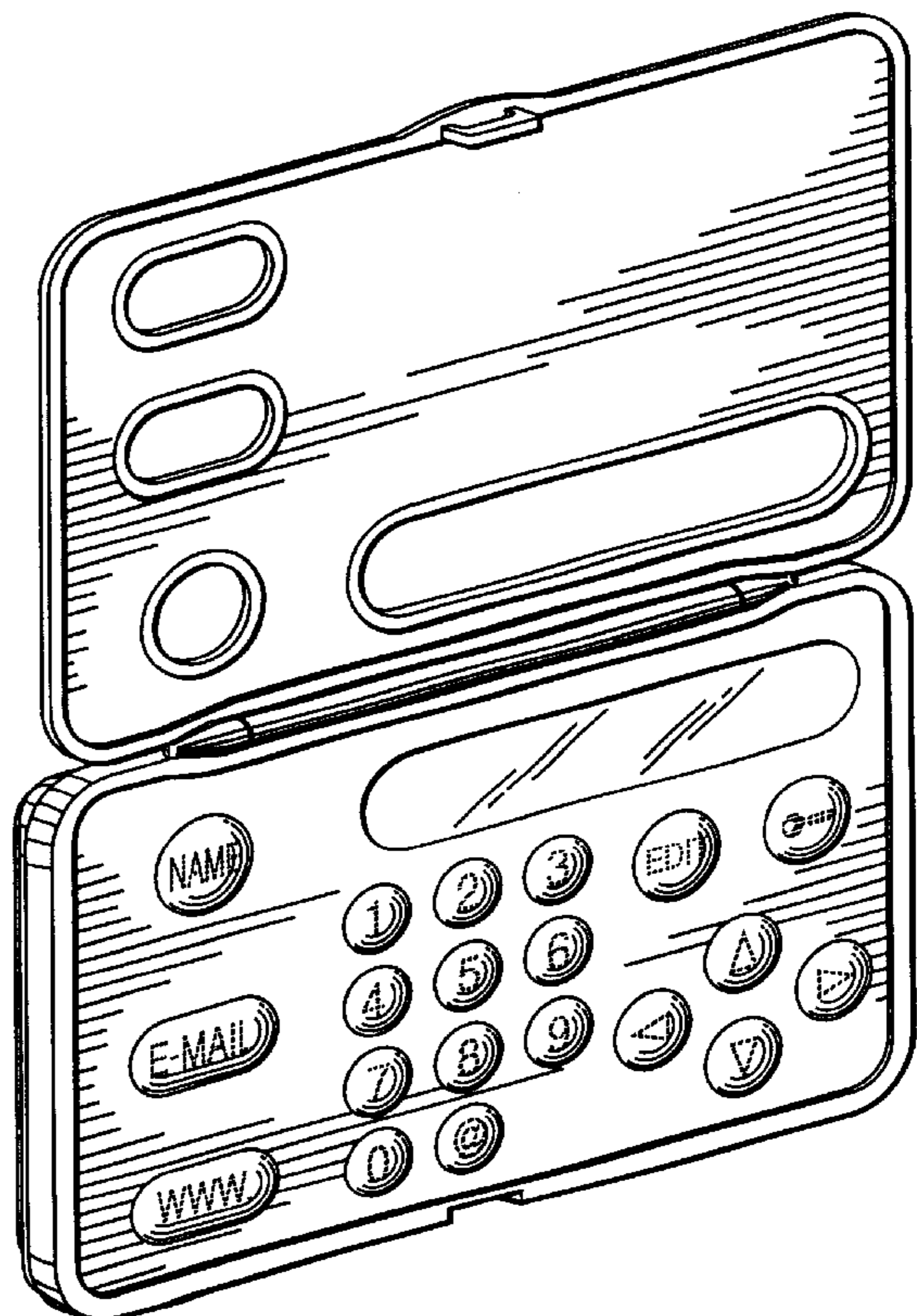
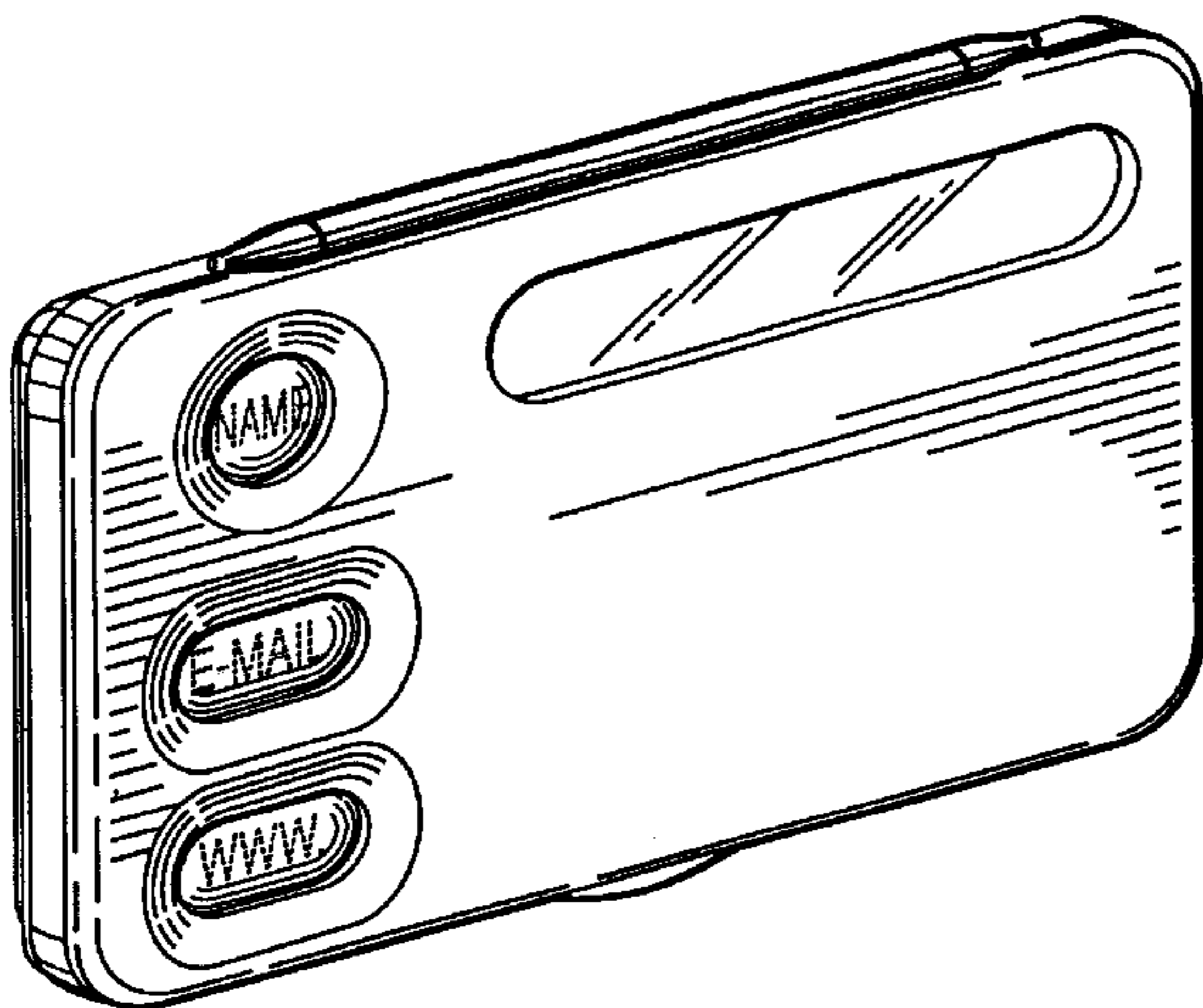

FIG. 5

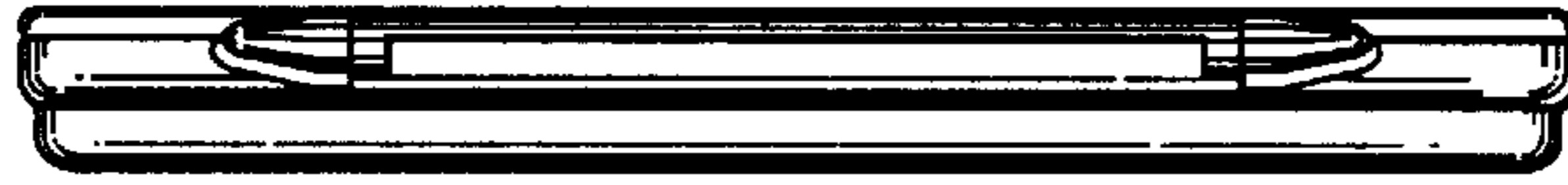

FIG. 4

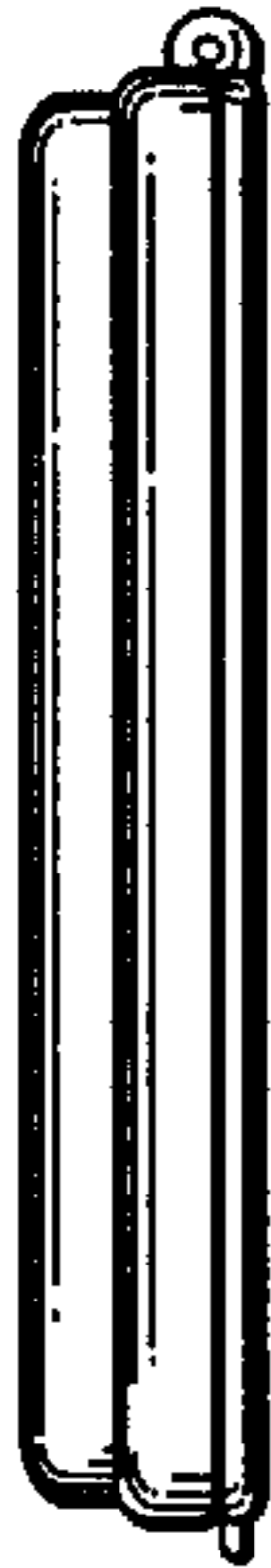

FIG. 1

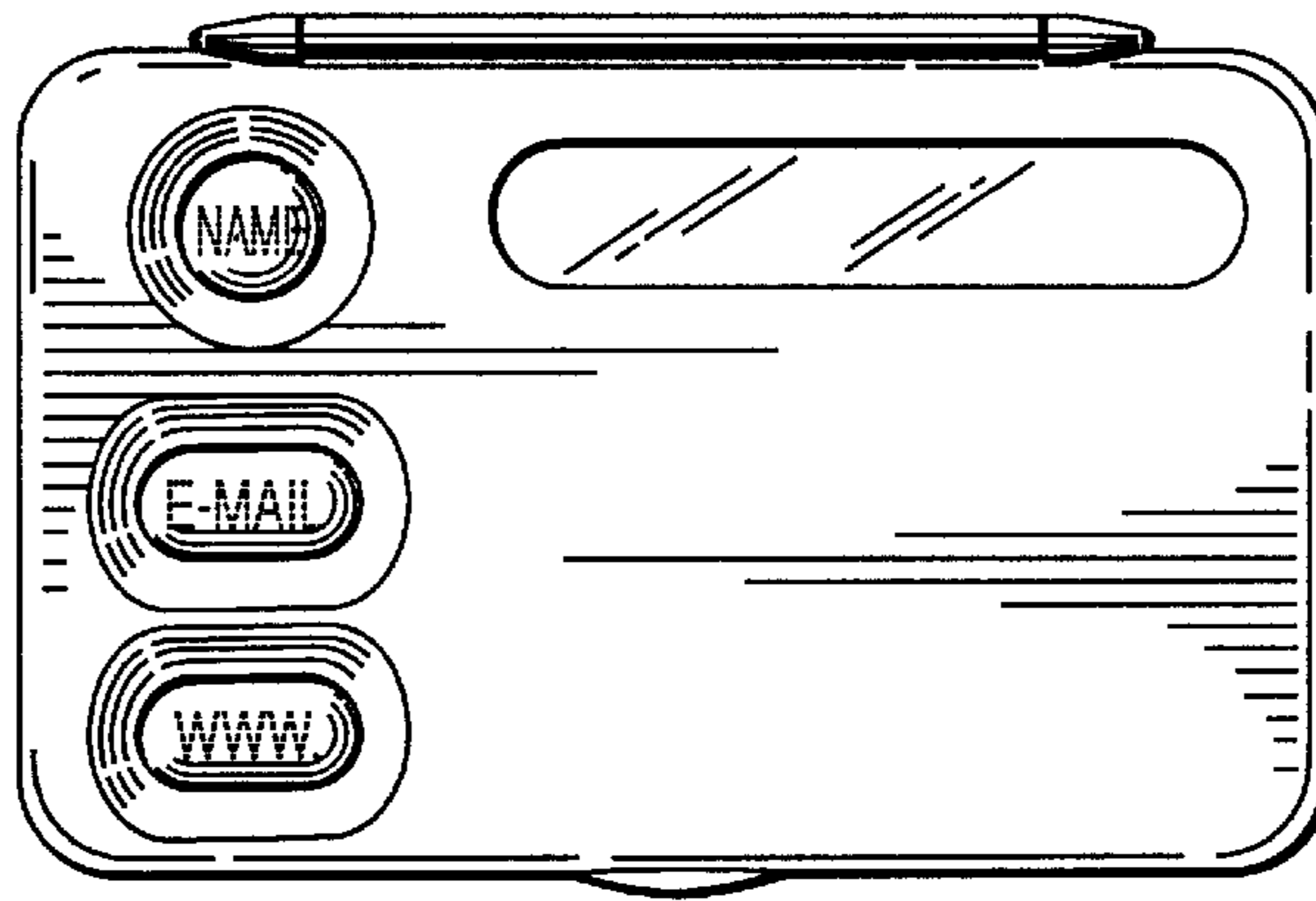

FIG. 2

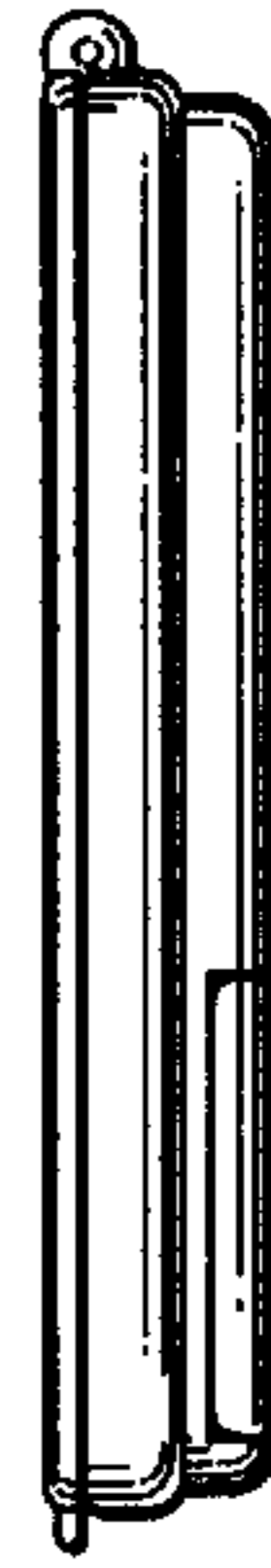

FIG. 3



FIG. 6

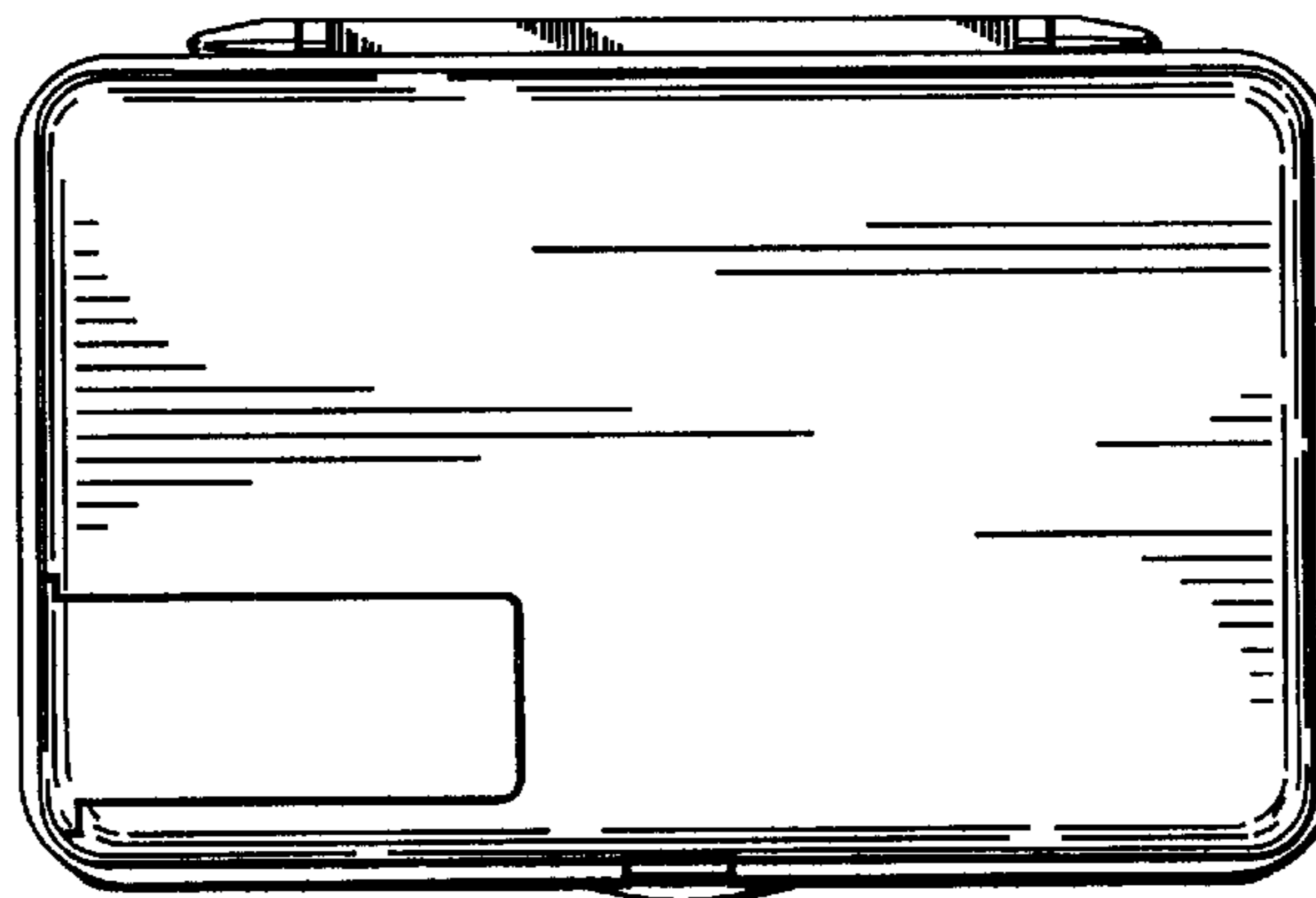

FIG. 7

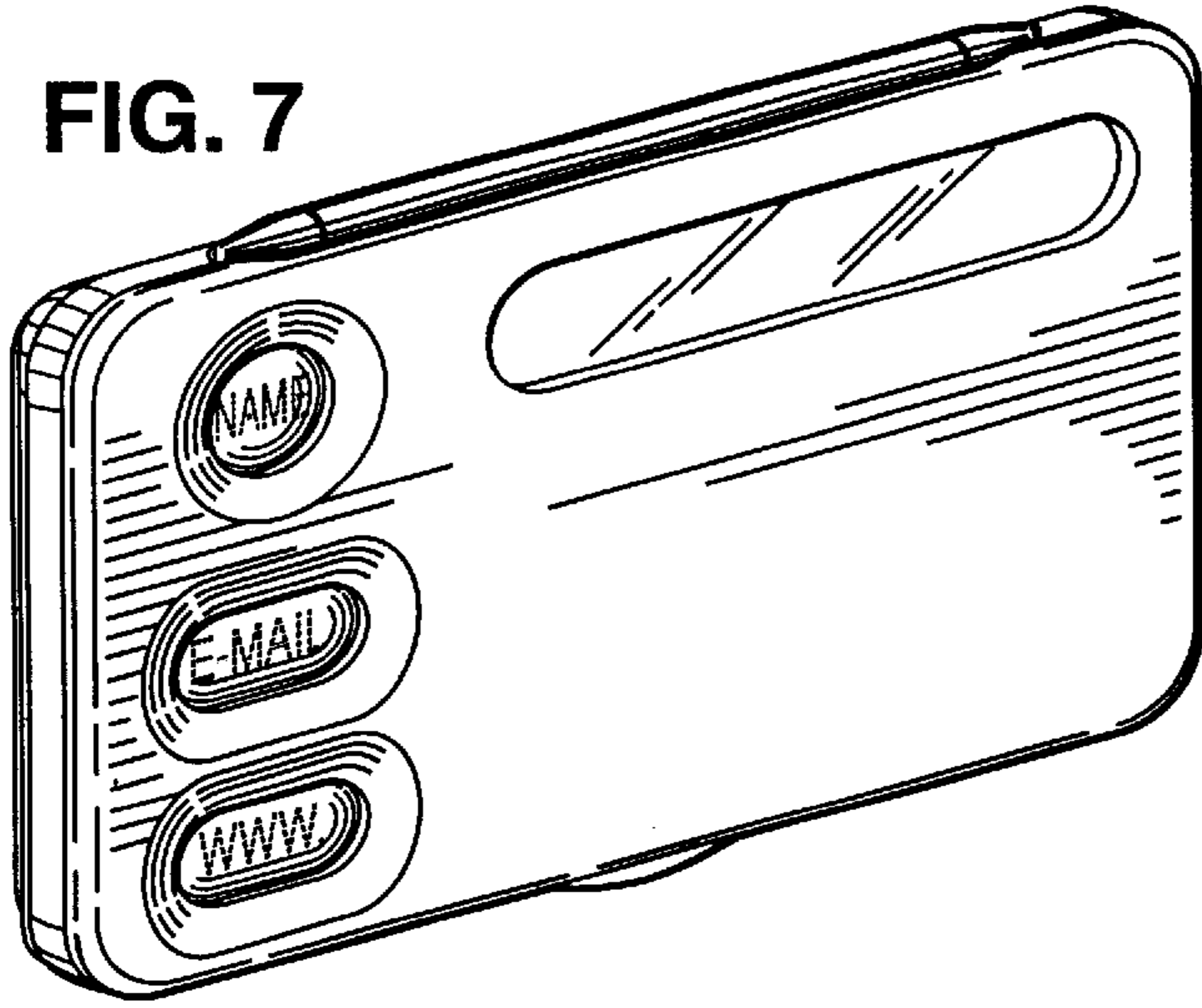

FIG. 12



FIG. 11

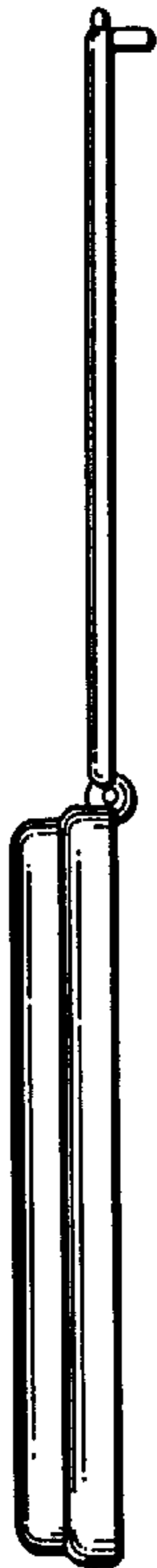

FIG. 8

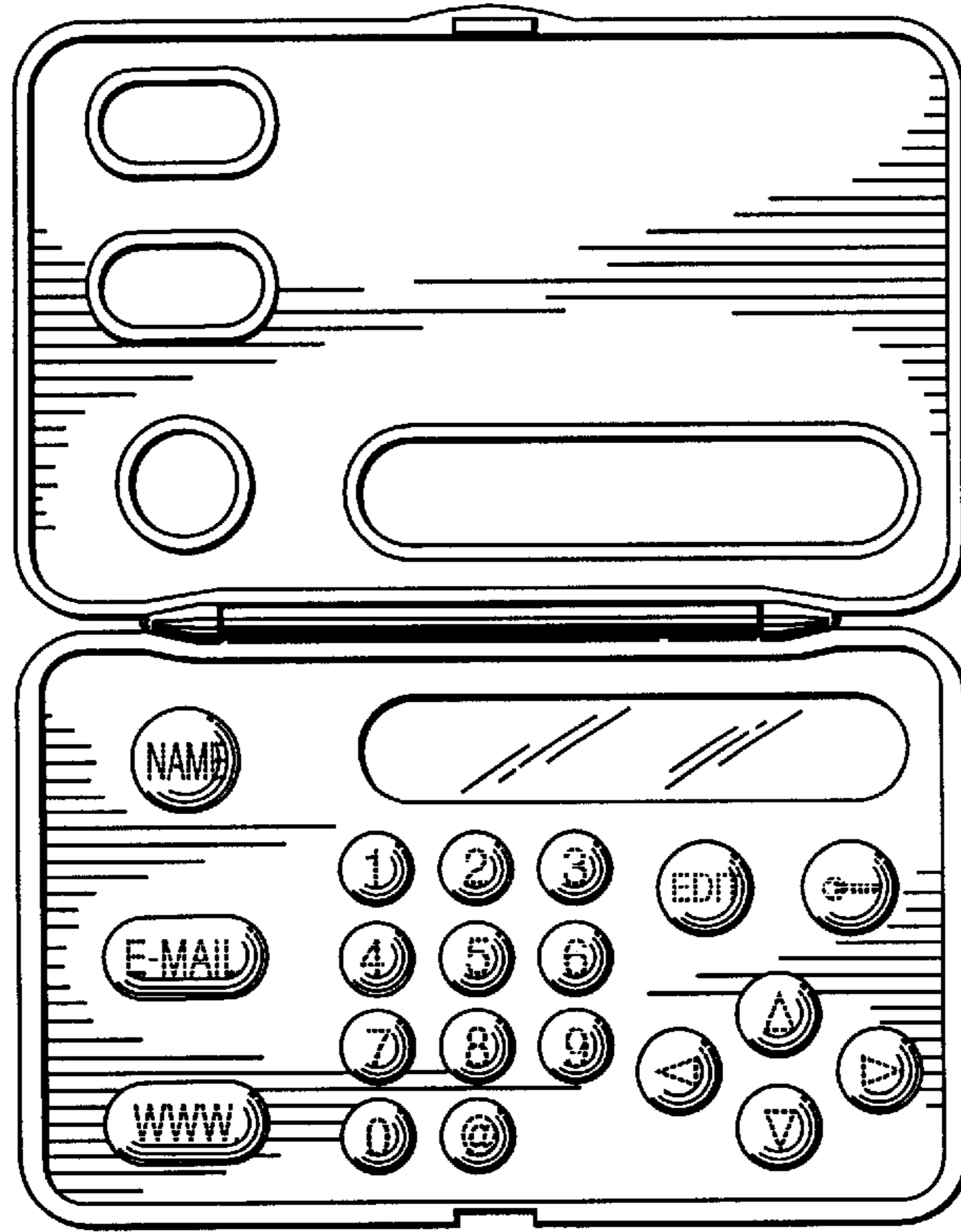

FIG. 9

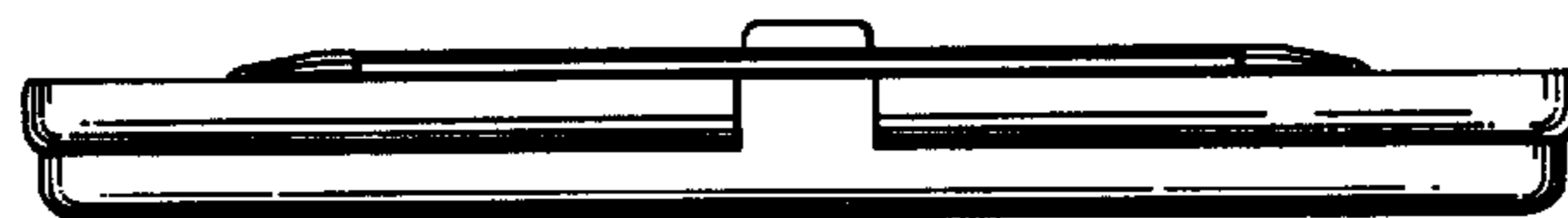
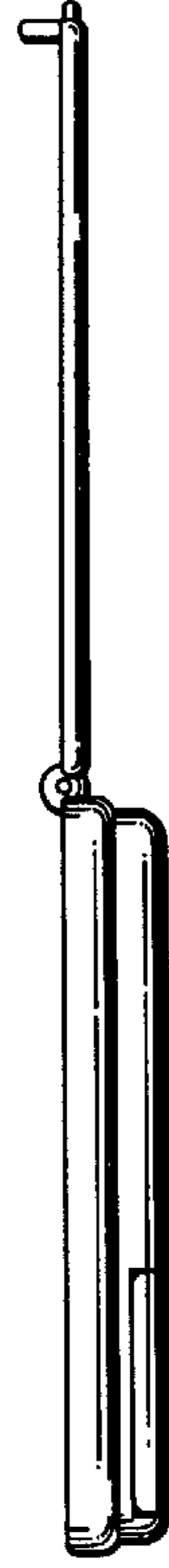

FIG. 10

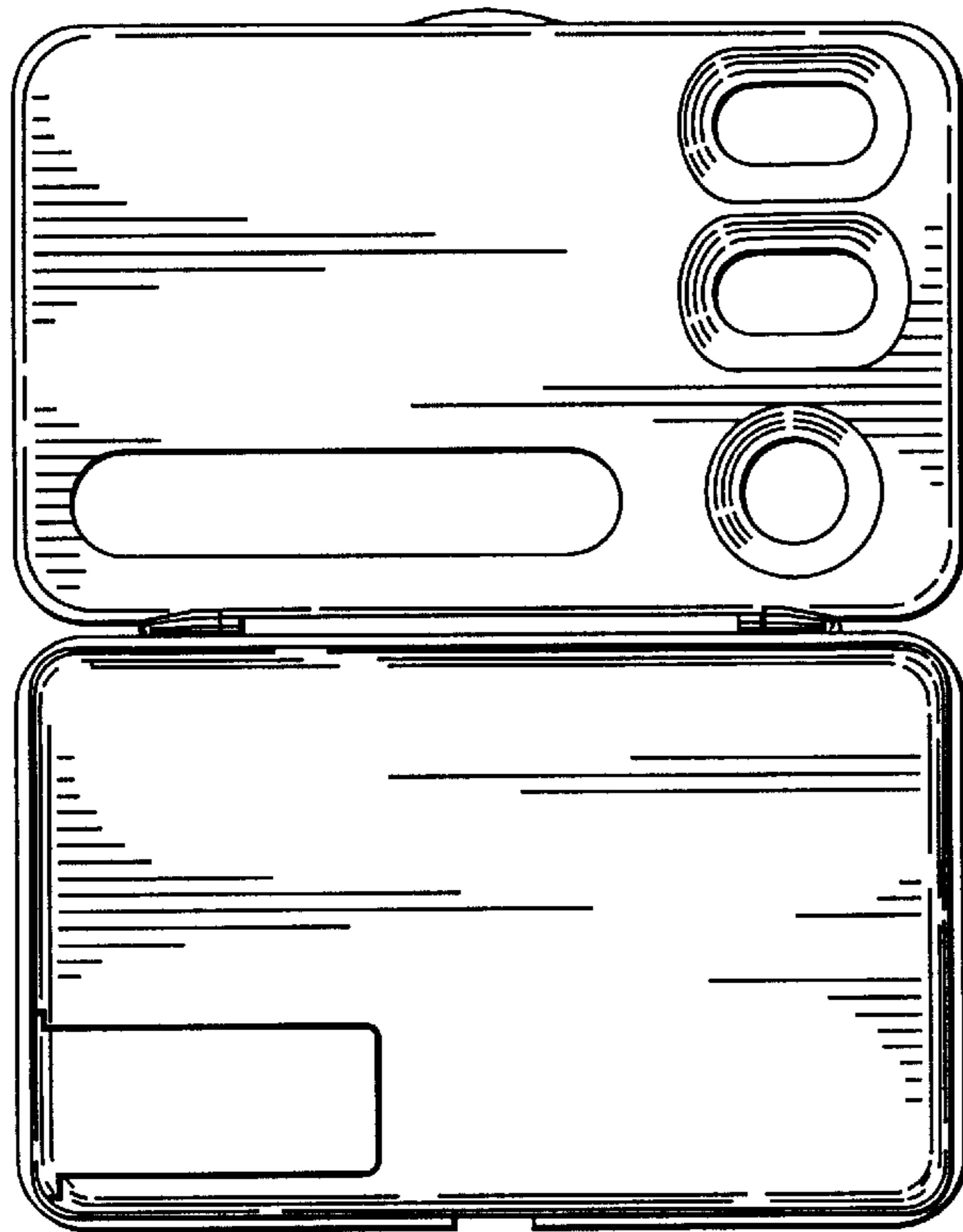

FIG. 13

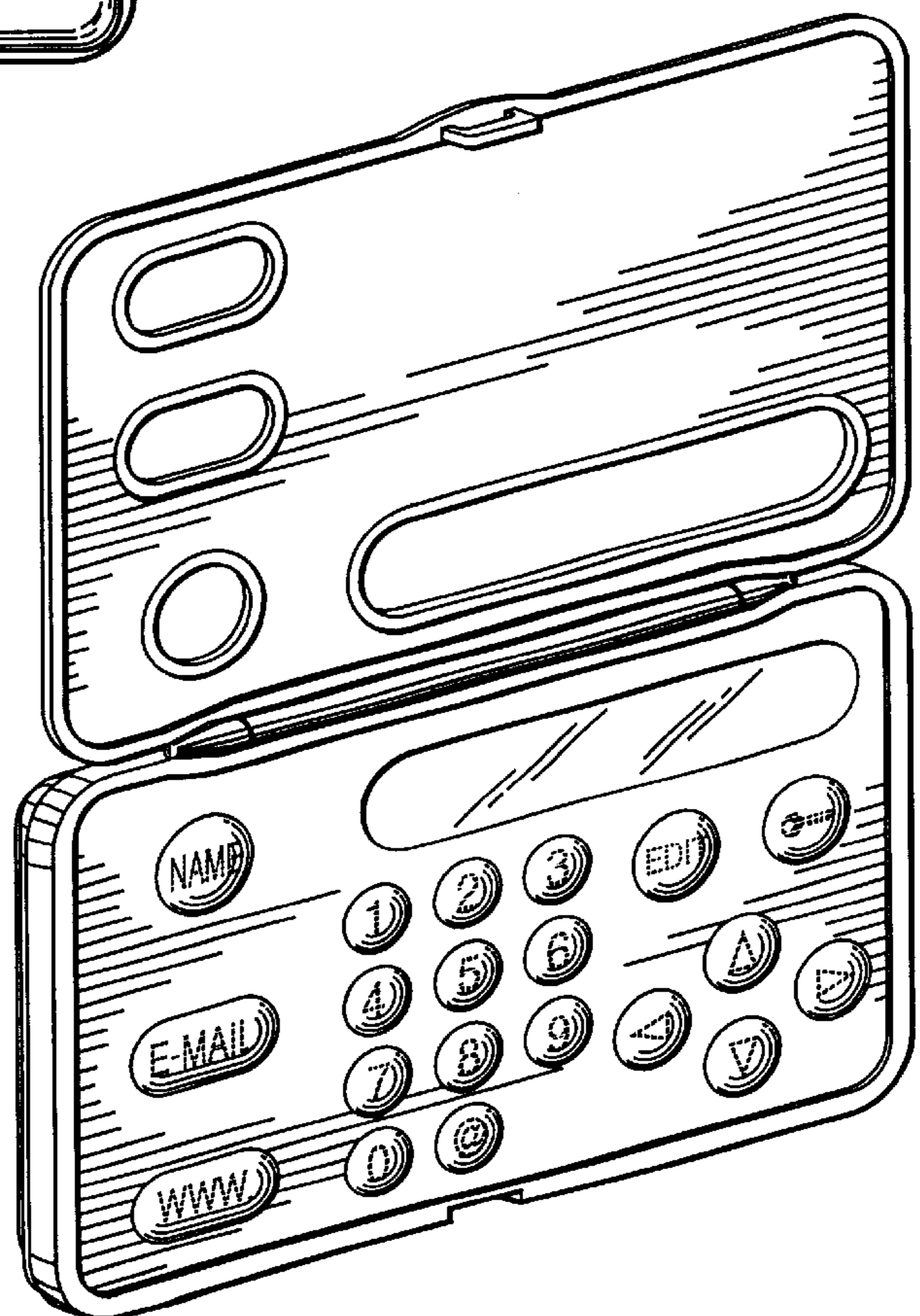

FIG. 14

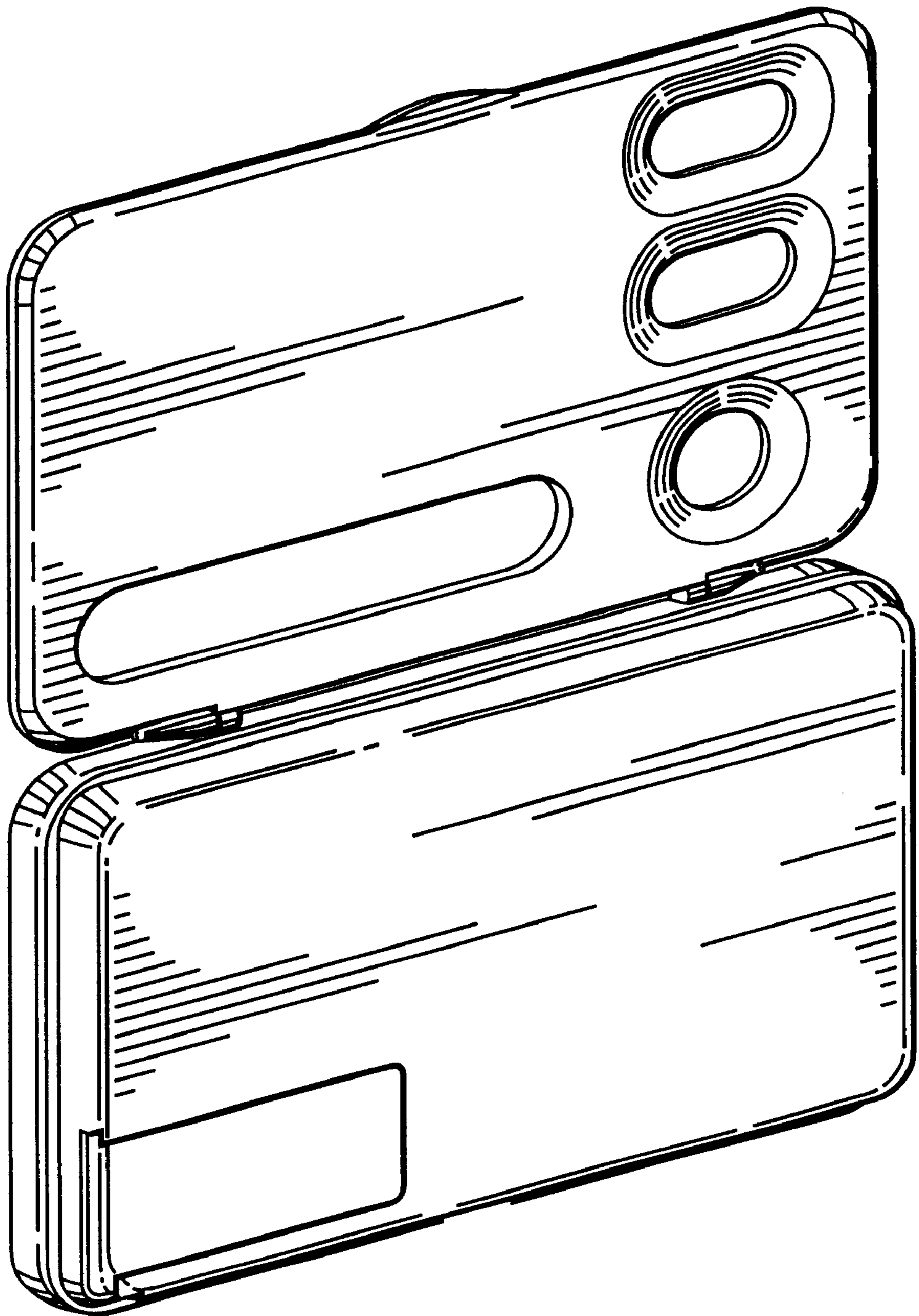

FIG. 15