



US00D460753S

(12) **United States Design Patent**
Hill et al.

(10) **Patent No.:** **US D460,753 S**

(45) **Date of Patent:** **** Jul. 23, 2002**

(54) **INTEGRATED COMMUNICATION ACCESS DEVICE**

(75) **Inventors:** **Peter G. Hill**, Ottawa; **Clifford D. Read**, Carp; **Jacques J. Gagnon**, Nepean; **Mark J. Sonderegger**, Kanata, all of (CA)

(73) **Assignee:** **Nortel Networks Limited**, St. Laurent (CA)

(**) **Term:** **14 Years**

(21) **Appl. No.:** **29/135,361**

(22) **Filed:** **Jan. 11, 2001**

(51) **LOC (7) Cl.** **14-03**

(52) **U.S. Cl.** **D14/240**

(58) **Field of Search** D14/137, 240, D14/138, 242, 308, 356, 357, 358, 311, 313, 441, 144, 348-355, 370, 341-347, 125, 432, 433, 155, 299, 257, 439, 140, 188, 230, 241, 243, 245; 379/433.01-433.13, 419, 434, 428.01-428.04, 420.01-420.04, 440, 441, 442; 455/550-575, 90; D13/184, 123, 152, 147, 110

(56) **References Cited**

U.S. PATENT DOCUMENTS

D366,248 S * 1/1996 Owens D13/184

D375,948 S * 11/1996 Langlois D14/471
D404,736 S * 1/1999 Alvarez et al. D14/229
D413,021 S * 8/1999 Wheatley et al. D3/273
D415,129 S * 10/1999 Wu D14/353
D415,769 S * 10/1999 Waldner D14/240
D435,044 S * 12/2000 Oviatt et al. D14/356
D436,596 S * 1/2001 Ito et al. D14/434
D437,860 S * 2/2001 Suzuki et al. D14/496
D438,532 S * 3/2001 Gargani et al. D14/240
D438,533 S * 3/2001 Arpe D14/240
D448,352 S * 9/2001 Atsushi D13/177

* cited by examiner

Primary Examiner—Jeffrey Asch

(74) *Attorney, Agent, or Firm*—Allan P. Millard

(57) **CLAIM**

The ornamental design for integrated communication access device, as shown and described.

DESCRIPTION

FIG. 1 is a perspective view thereof;

FIG. 2 is a front view thereof;

FIG. 3 is a back view thereof;

FIG. 4 is a top view thereof;

FIG. 5 is a bottom view thereof;

FIG. 6 is a right side view thereof; and,

FIG. 7 is a left side view thereof.

The characteristic features of the design reside in the shape, ornamentation and configuration of the entire device.

1 Claim, 4 Drawing Sheets

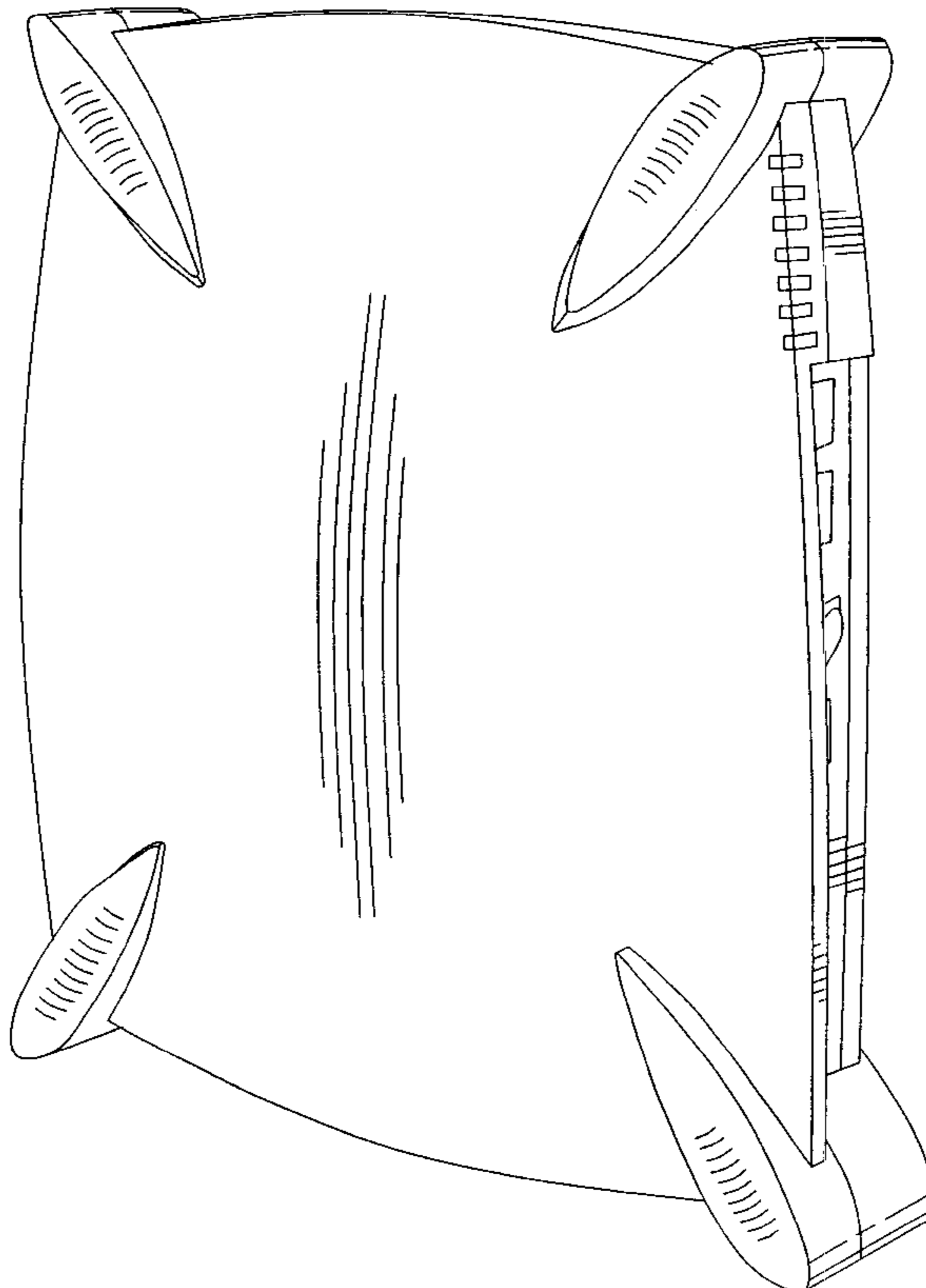

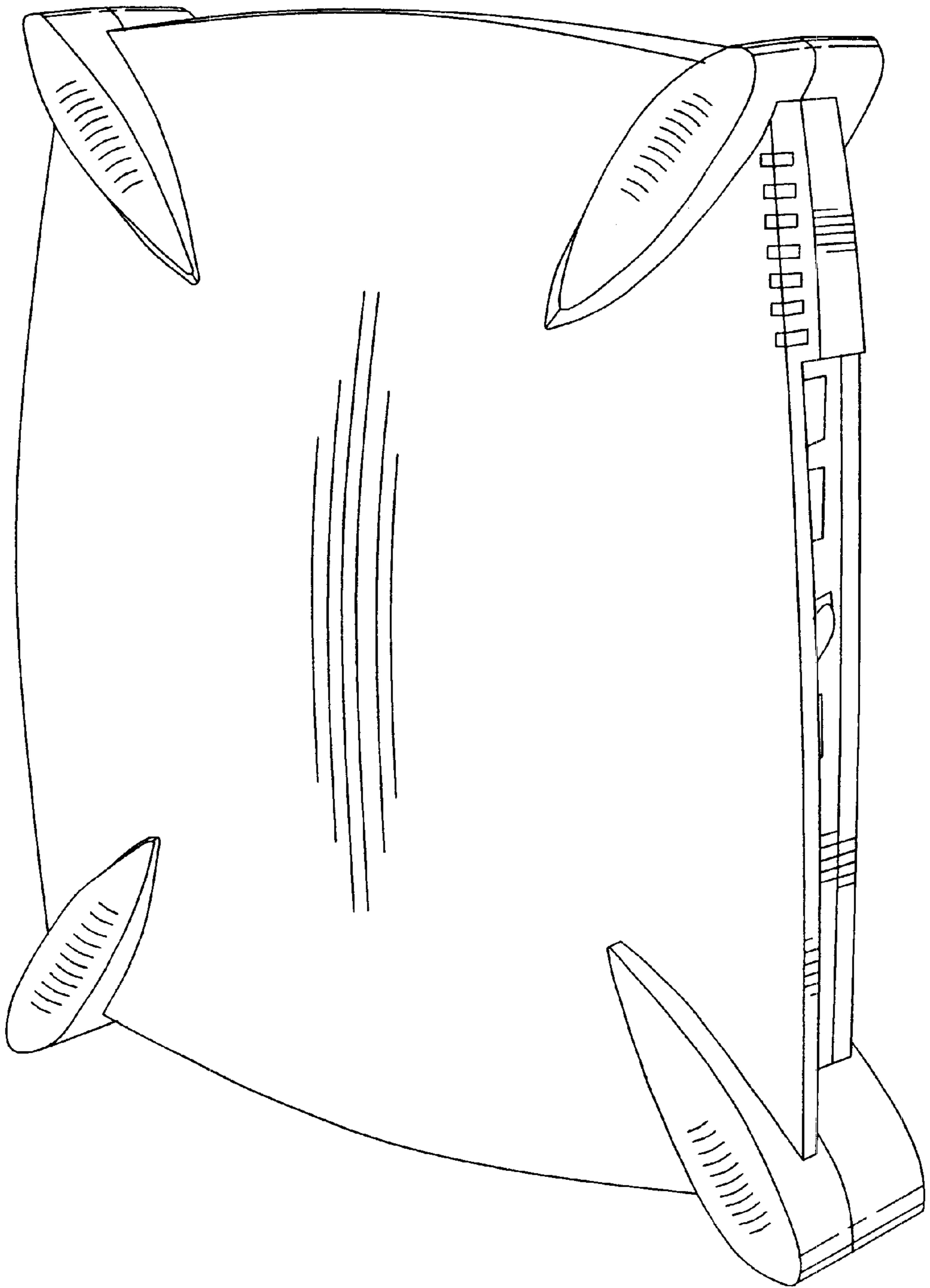

FIG. 1

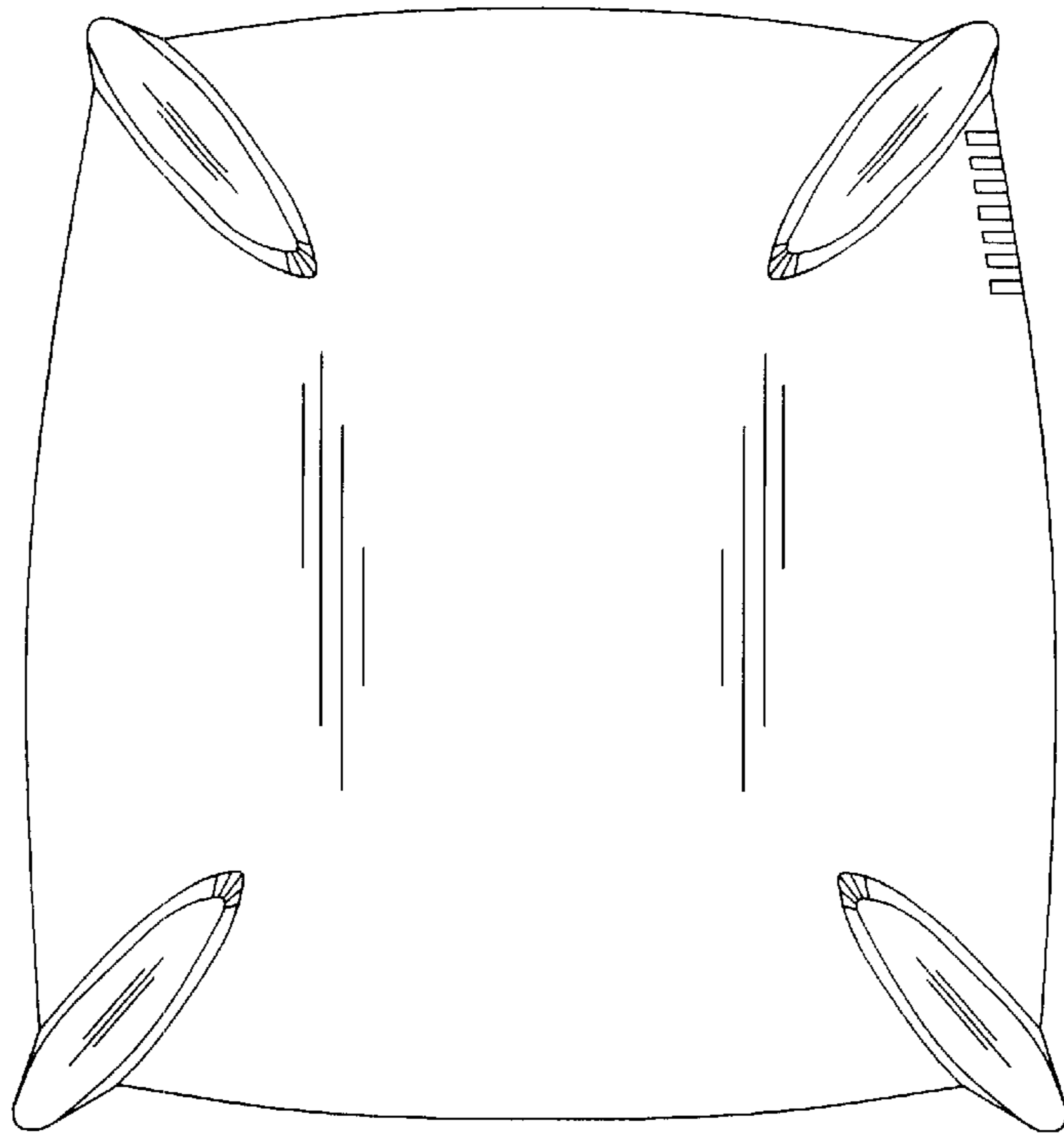

FIG. 2

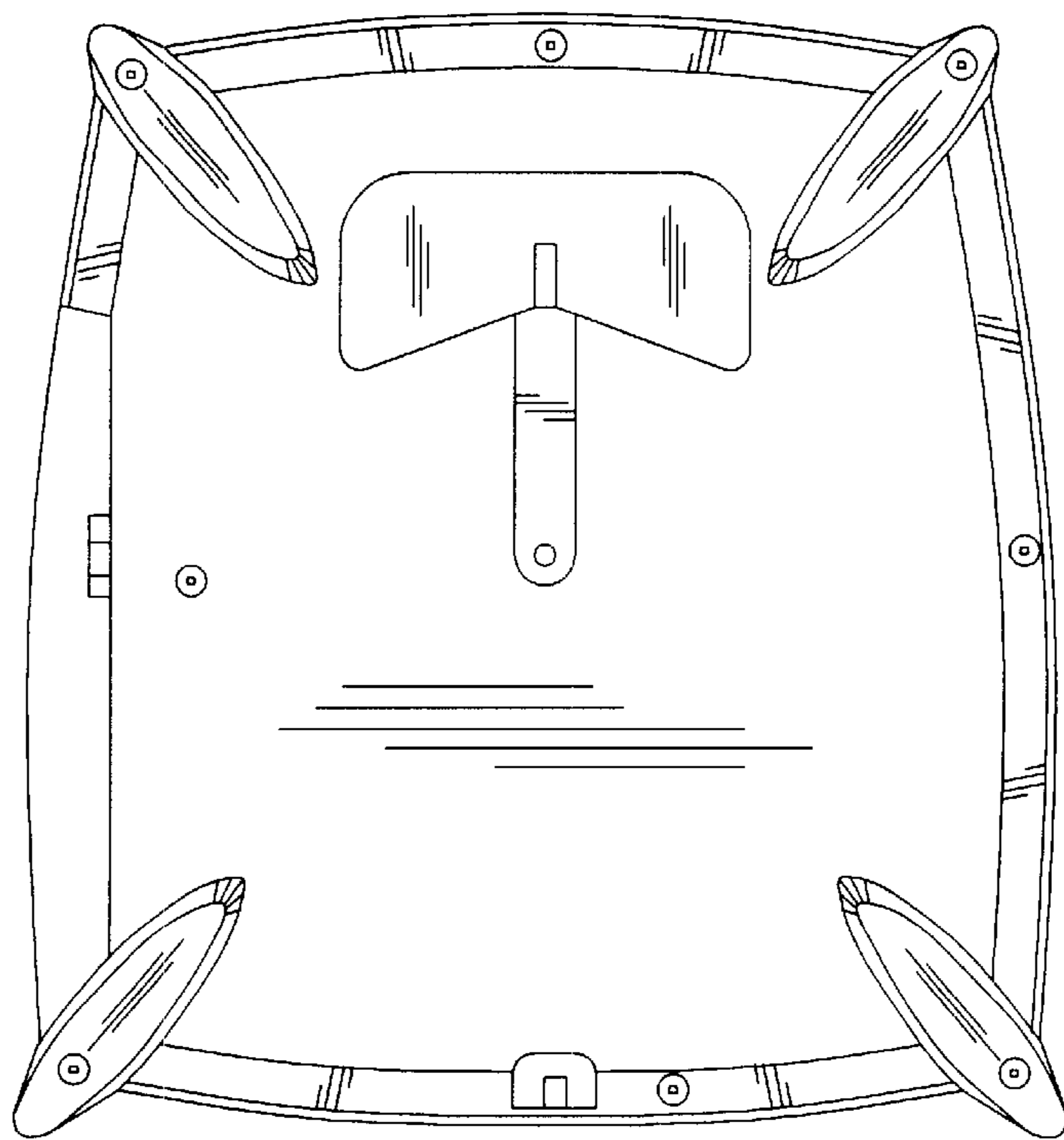

FIG. 3

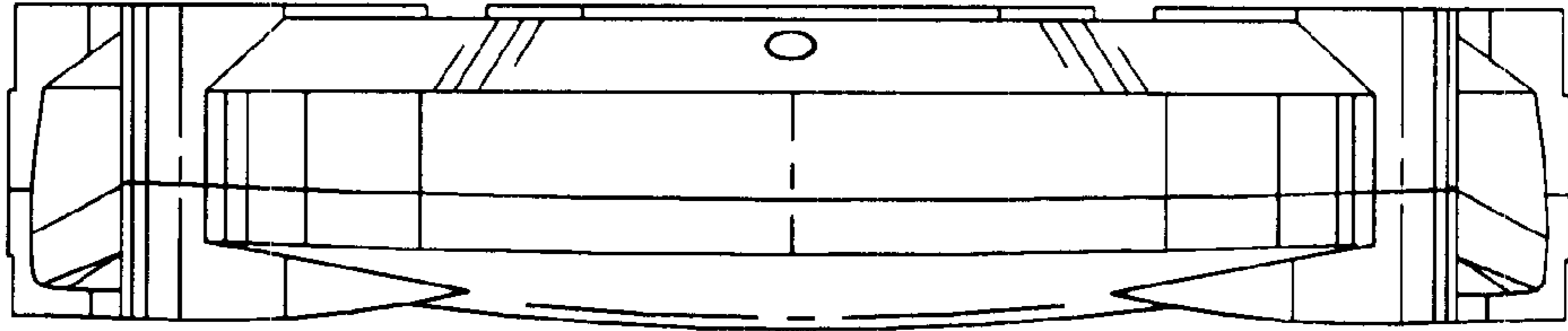

FIG. 4

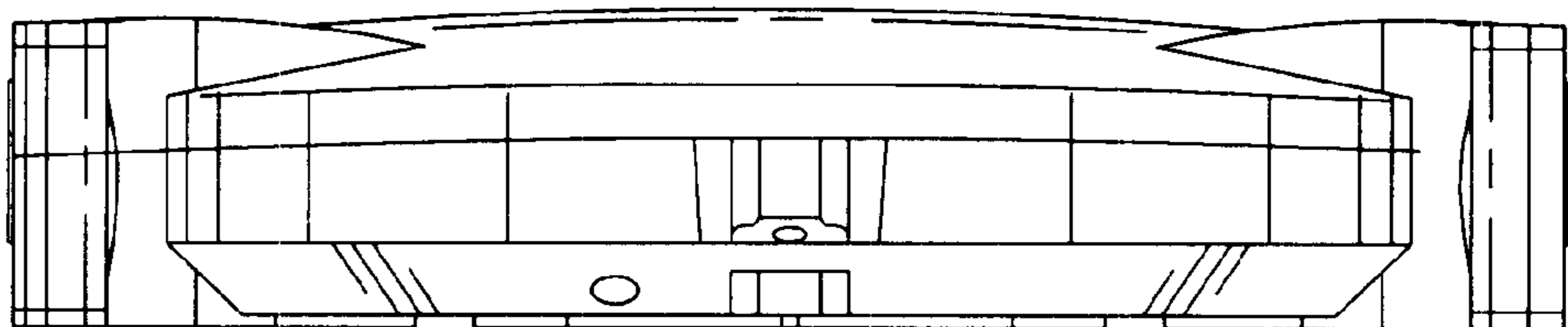

FIG. 5

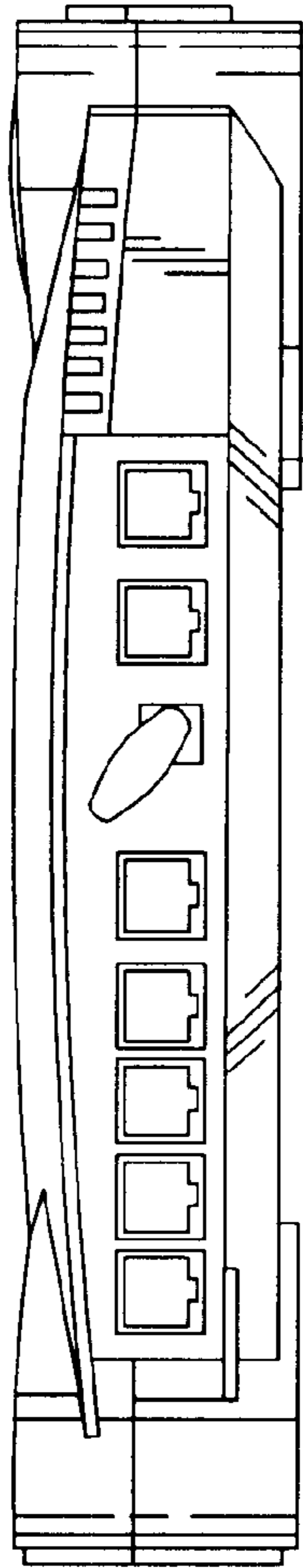

FIG. 6

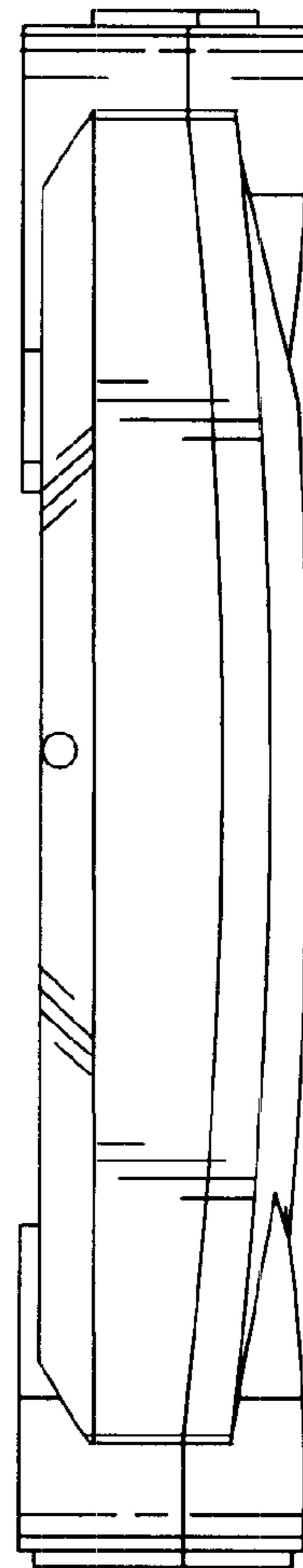

FIG. 7