

US00D460718S

(12) **United States Design Patent**
Beattie

(10) **Patent No.:** **US D460,718 S**

(45) **Date of Patent:** **** Jul. 23, 2002**

(54) **PLANTER FOR A MAILBOX**

(74) *Attorney, Agent, or Firm*—Senniger, Powers, Leavitt & Roedel

(76) **Inventor:** **Rebecca M. Beattie**, 2122 White Lane Dr., Chesterfield, MO (US) 63017

(57) **CLAIM**

(**) **Term:** **14 Years**

The ornamental design for a planter for a mailbox, as shown and described.

(21) **Appl. No.:** **29/143,421**

DESCRIPTION

(22) **Filed:** **Jun. 13, 2001**

(51) **LOC (7) Cl.** **11-02**

(52) **U.S. Cl.** **D11/155; D6/405; D11/148**

(58) **Field of Search** D11/143, 144, D11/155, 156; D6/403, 405, 513, 556, 558; D99/29, 31; 47/44–47; 206/432; 211/71.01, 85.23, 85.31; 248/27.8, 312.1, 311.2

FIG. 1 is a perspective view of a planter for a mailbox; FIG. 2 is a front elevational view thereof; FIG. 3 is a rear elevational view thereof; FIG. 4 is a left side elevational view thereof, the right side elevational view being a mirror image of the left; FIG. 5 is a top plan view thereof; FIG. 6 is a bottom plan view thereof; FIG. 7 is a front elevational view of a second embodiment of my new design comprising a planter for a mailbox, the rear elevational view being a mirror image of the front; FIG. 8 is a top plan view of the second embodiment; FIG. 9 is a bottom plan view thereof; FIG. 10 is a left side elevational view of the second embodiment; FIG. 11 is a right side elevational view thereof; FIG. 12 is a front elevational view of a third embodiment of my new design comprising a planter for a mailbox, the rear elevational view being a mirror image of the front; FIG. 13 is a top plan view of the third embodiment; FIG. 14 is a bottom plan view thereof; FIG. 15 is a left side elevational view of the third embodiment; and, FIG. 16 is a right side elevational view thereof. Portions of the views shown in phantom form no part of the design.

(56) **References Cited**

U.S. PATENT DOCUMENTS

D312,912 S	12/1990	Klahre	
D313,105 S	12/1990	Klahre	
D322,418 S	12/1991	White	
5,181,621 A *	1/1993	Plaehn 248/311.2
D339,942 S *	10/1993	Emalfarb et al. D6/513
D348,633 S	7/1994	Emalfarb et al.	
D353,790 S	12/1994	Emalfarb et al.	
5,390,443 A	2/1995	Emalfarb et al.	
5,423,504 A *	6/1995	Shenkar 248/311.2
5,711,433 A	1/1998	Smith	
D412,080 S *	7/1999	Emery et al. D6/513
D415,915 S *	11/1999	Camilleri et al. D6/513
D417,798 S	12/1999	Henson	
6,032,808 A	3/2000	Henson	
D448,321 S *	9/2001	Jones et al. D11/156

* cited by examiner

Primary Examiner—Doris V. Coles

Assistant Examiner—Mimosa De

1 Claim, 16 Drawing Sheets

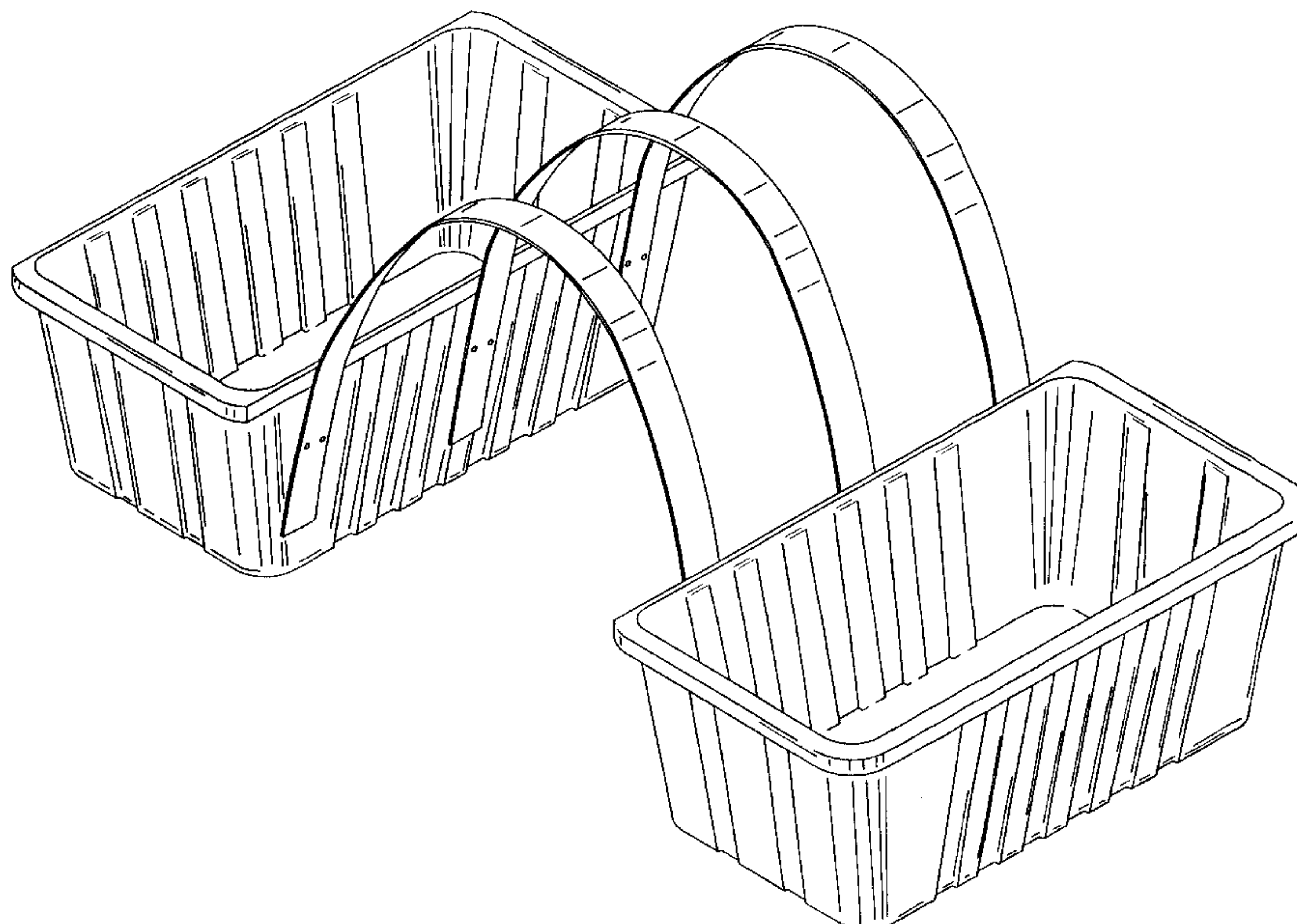

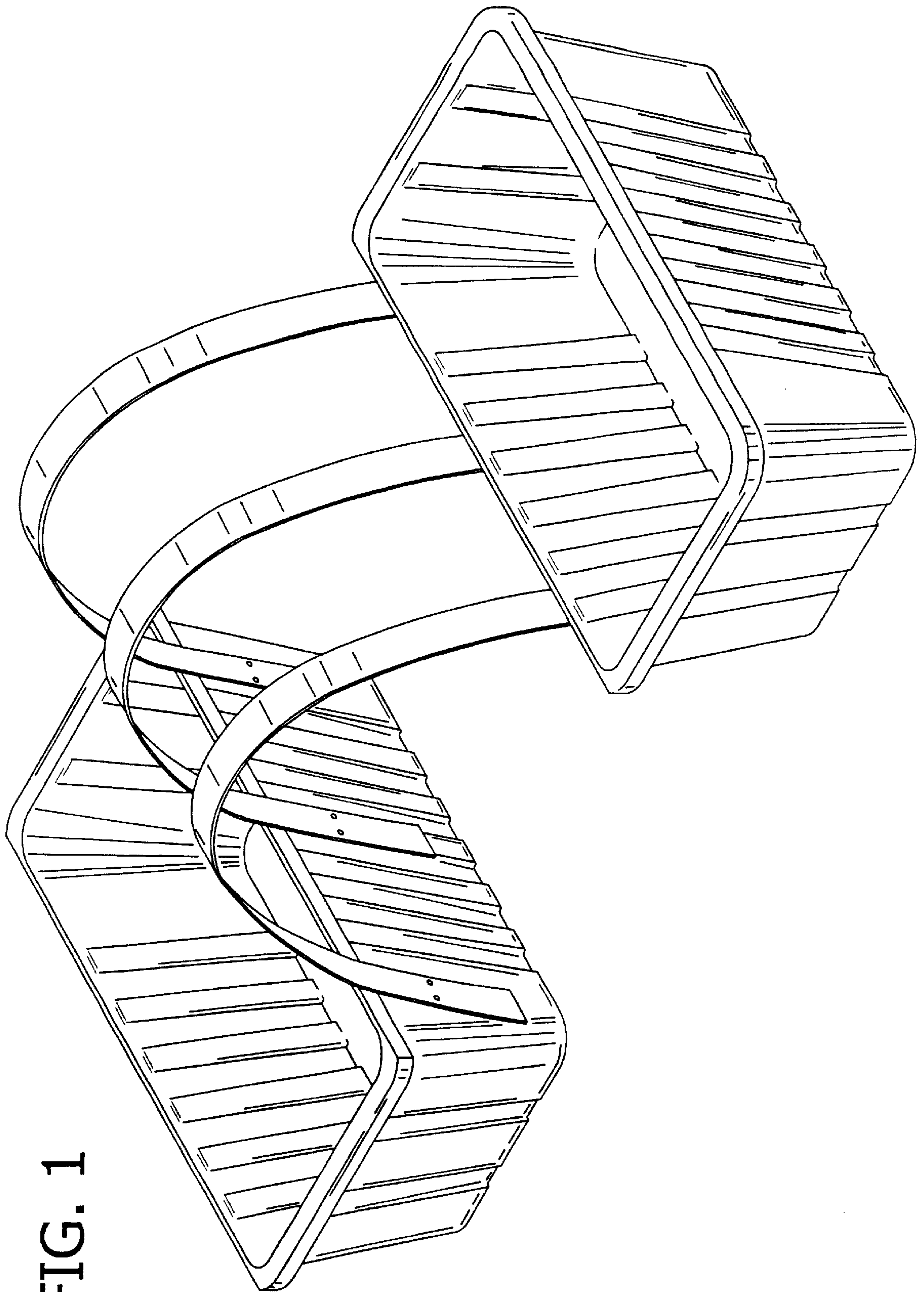

FIG. 1

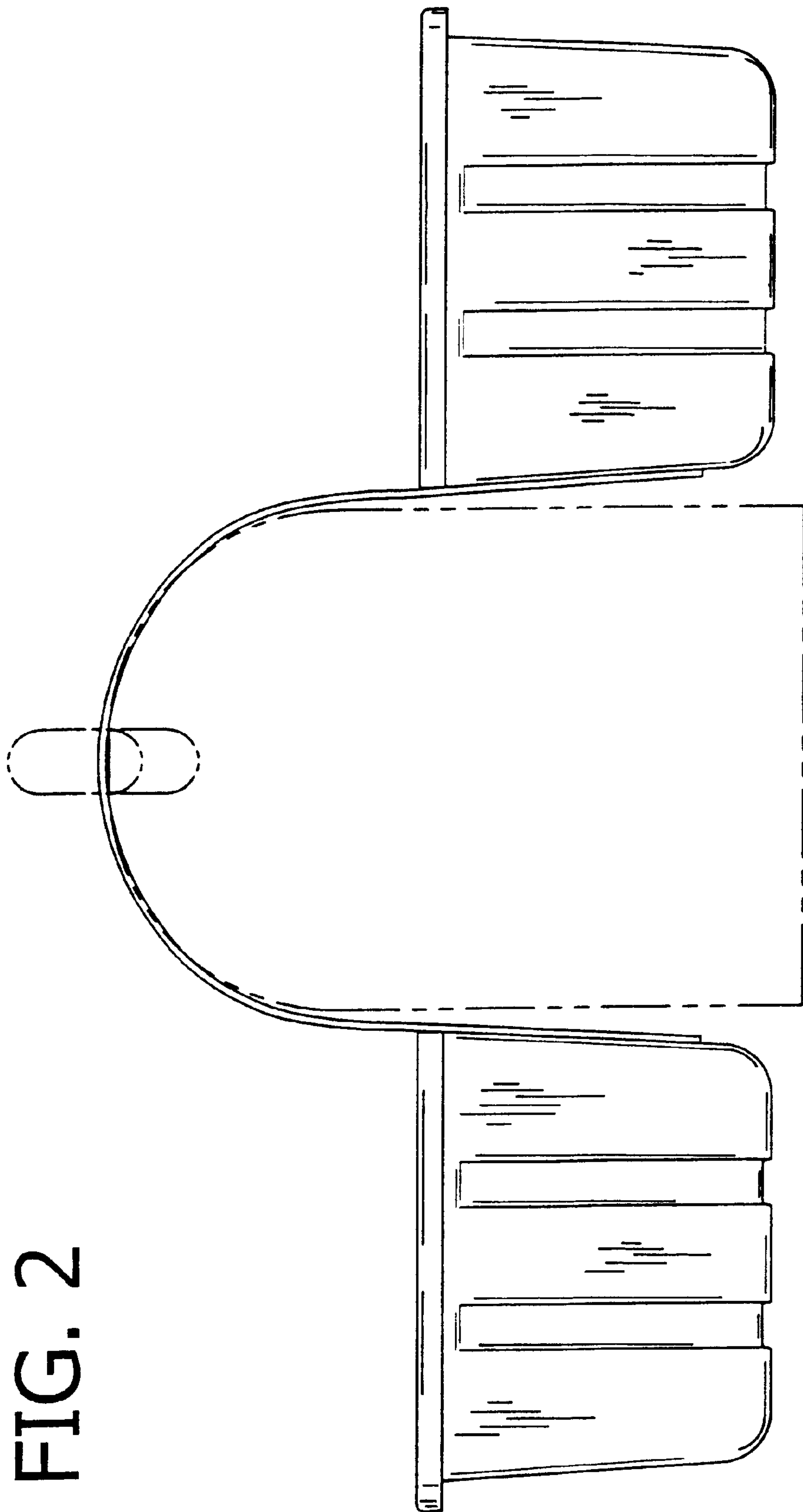

FIG. 2

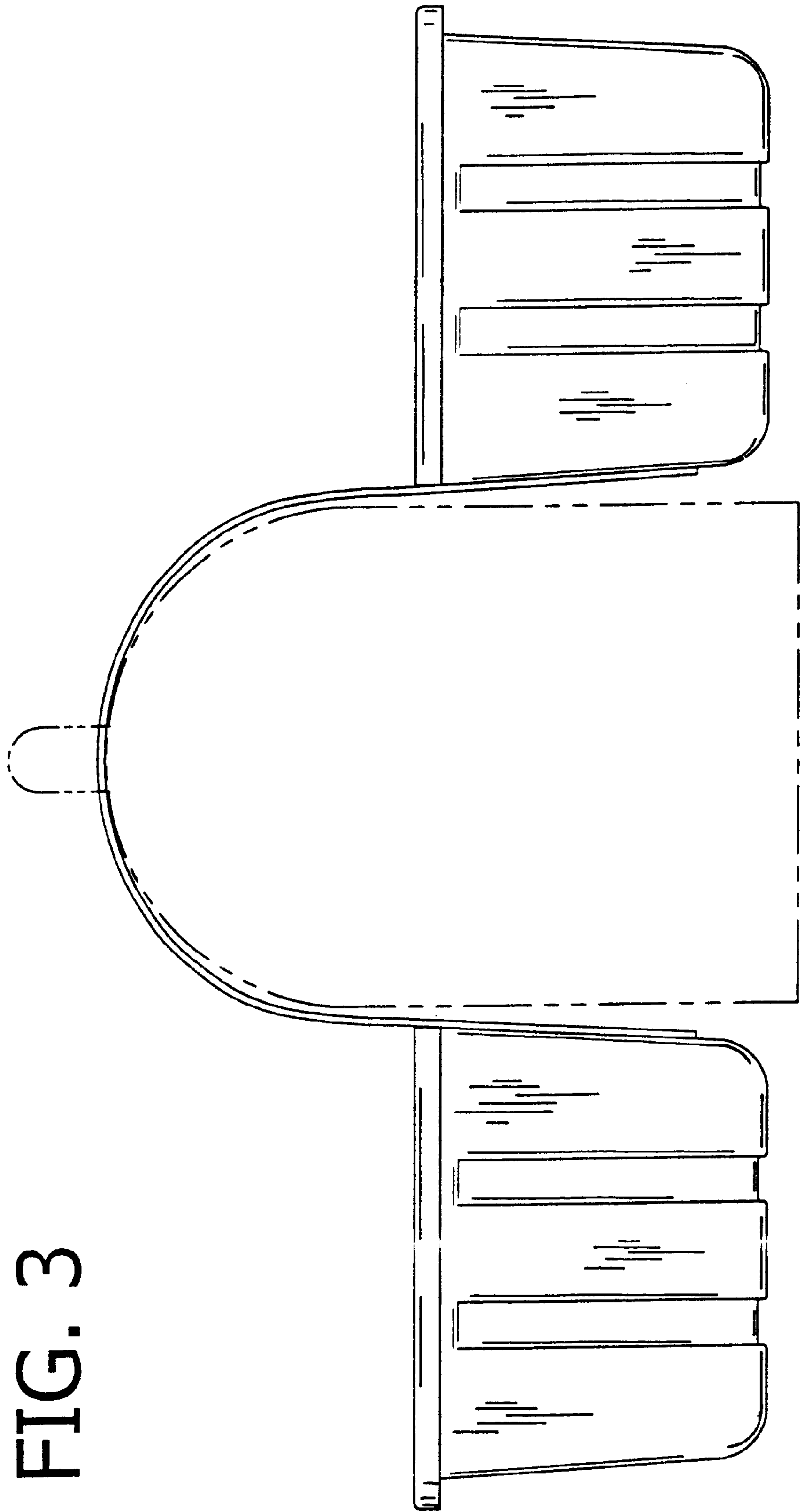

FIG. 3

FIG. 4

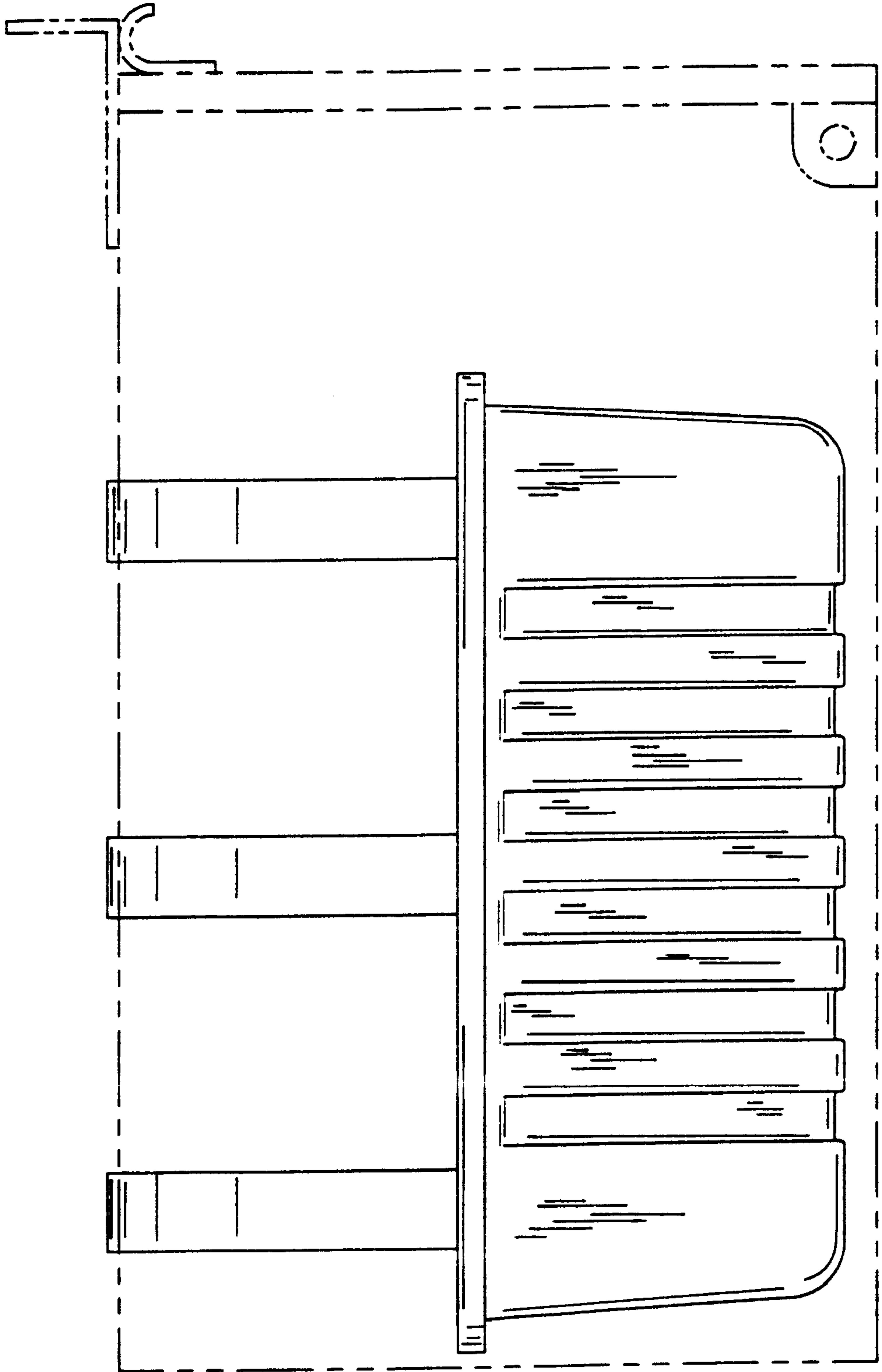
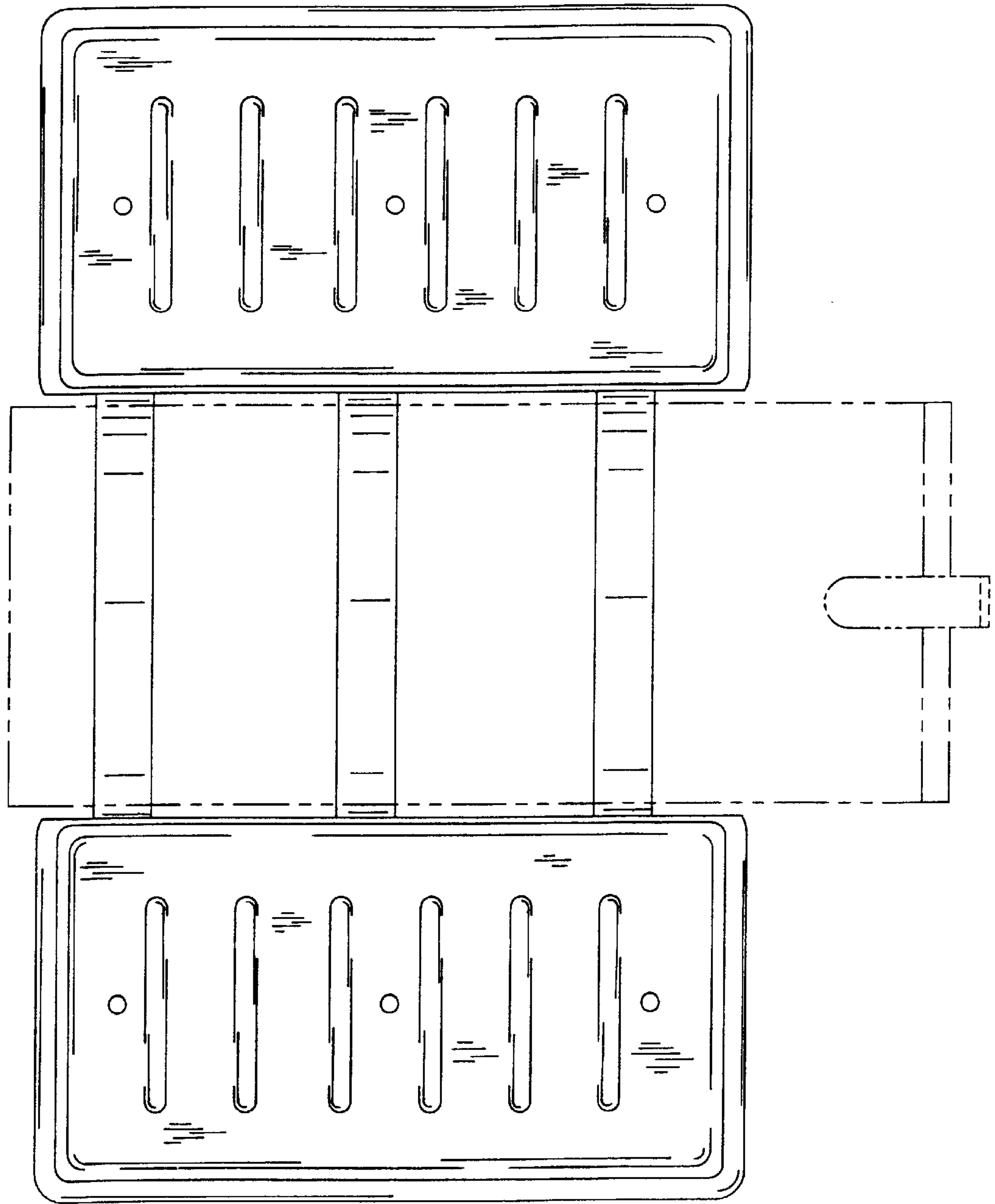

FIG. 5



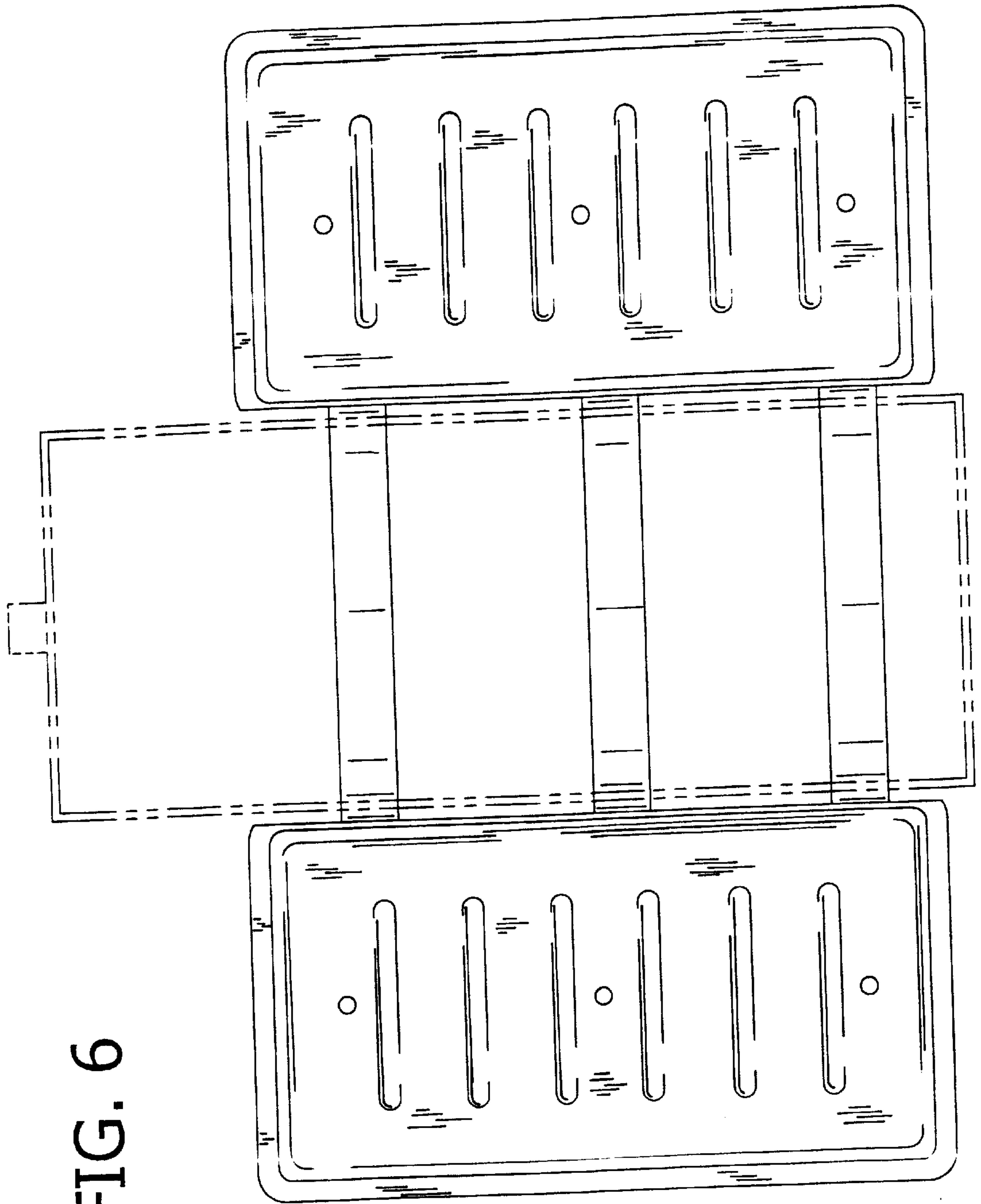

FIG. 6

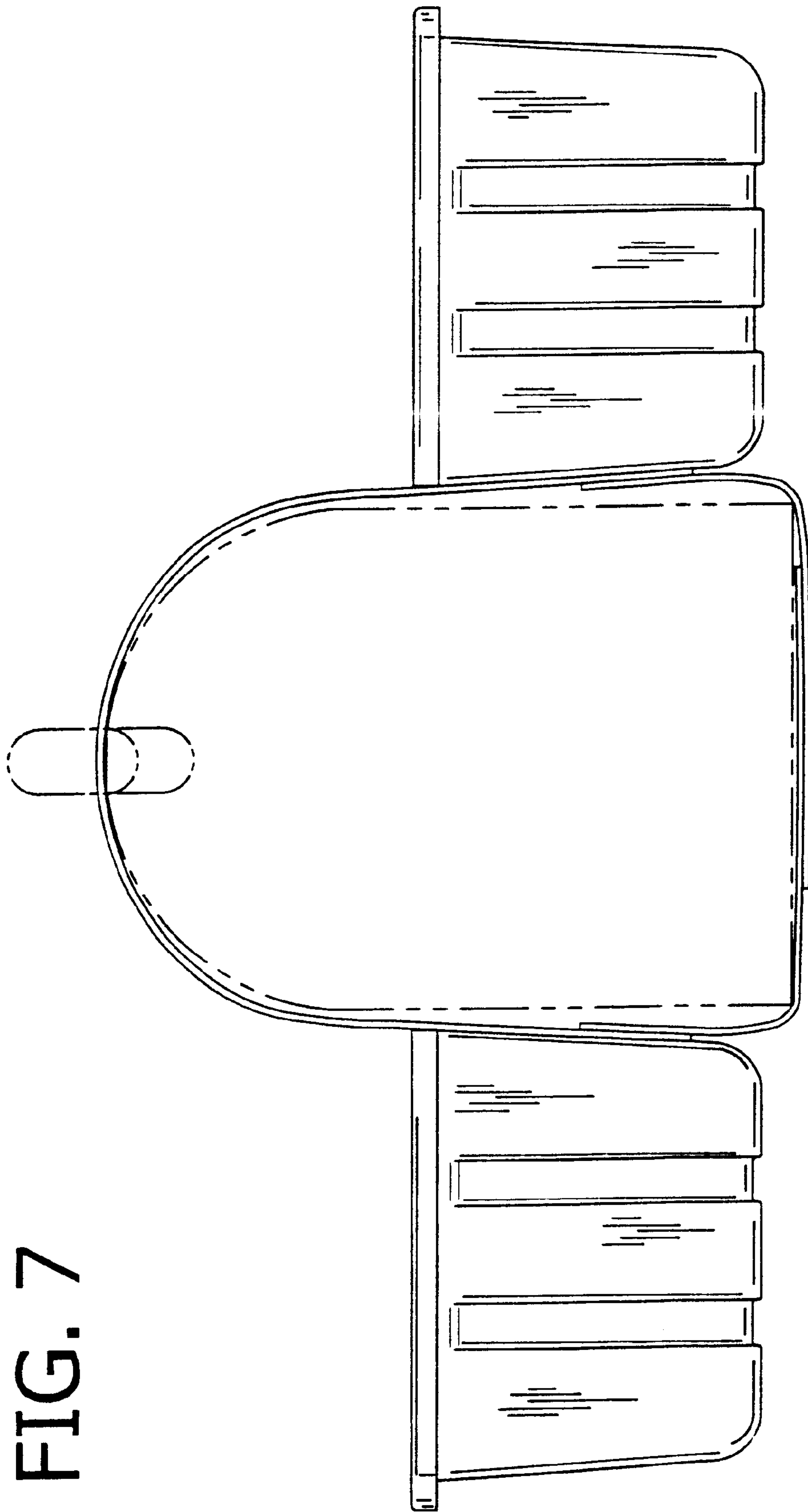
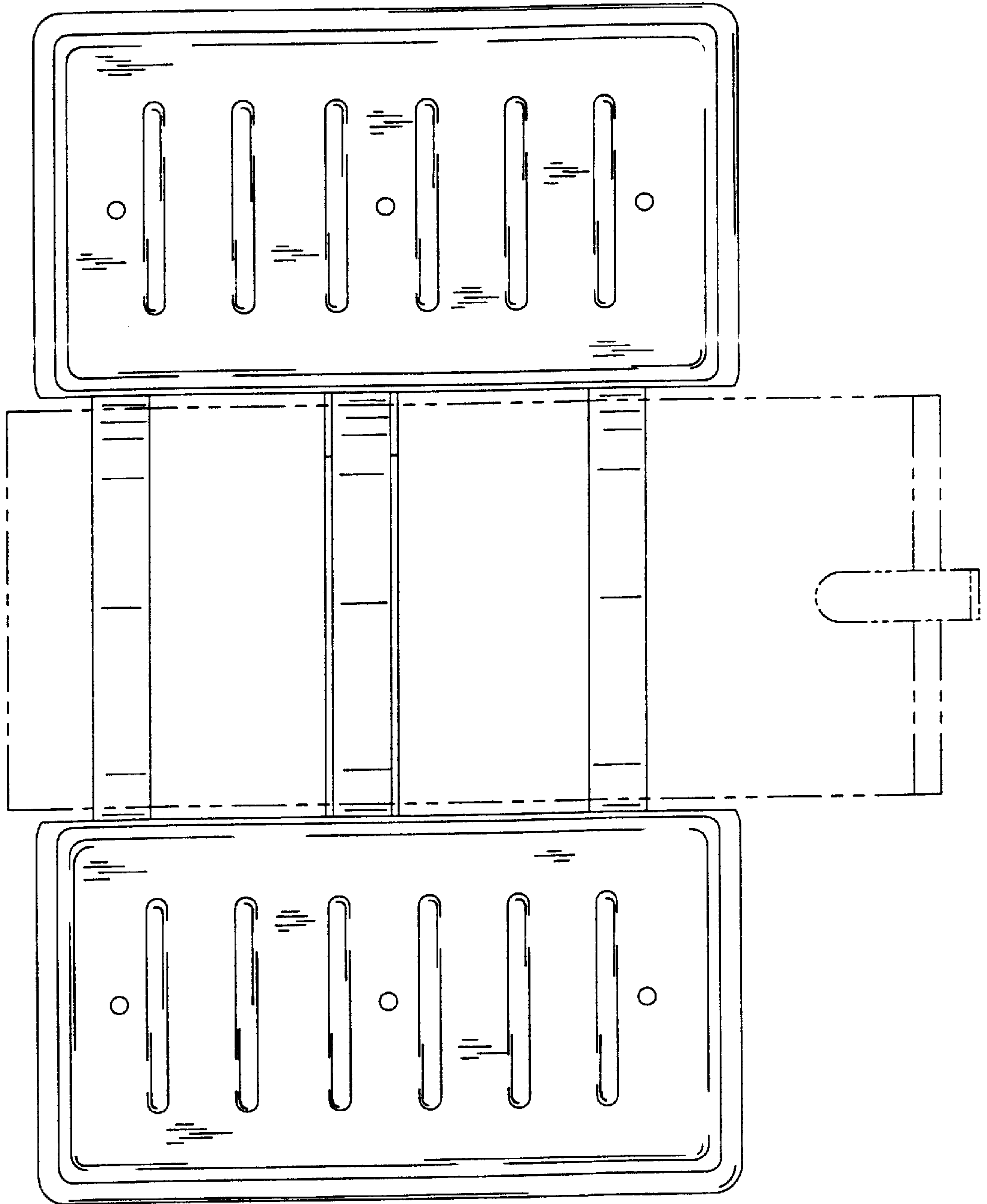

FIG. 7

FIG. 8



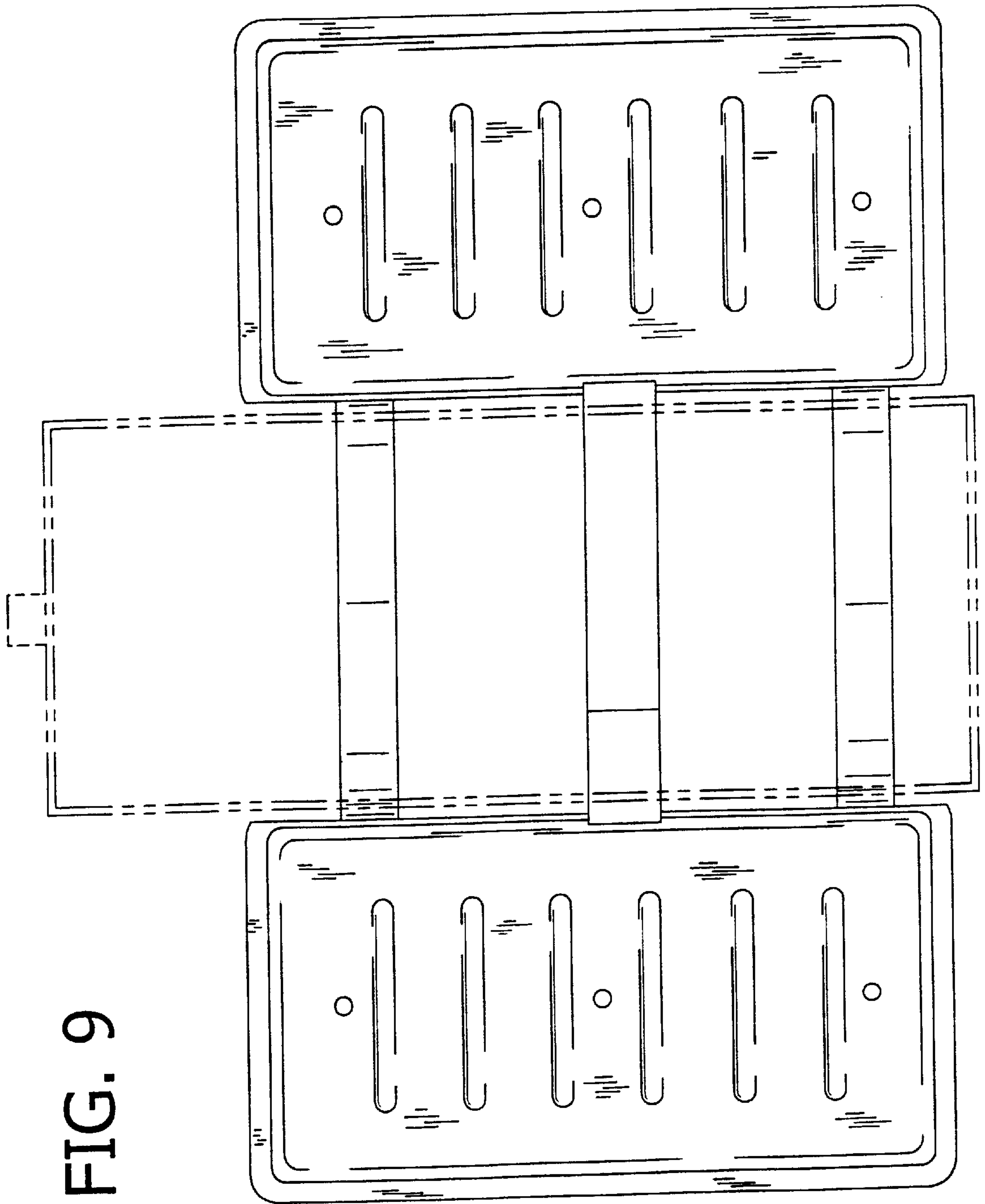

FIG. 9

FIG. 10

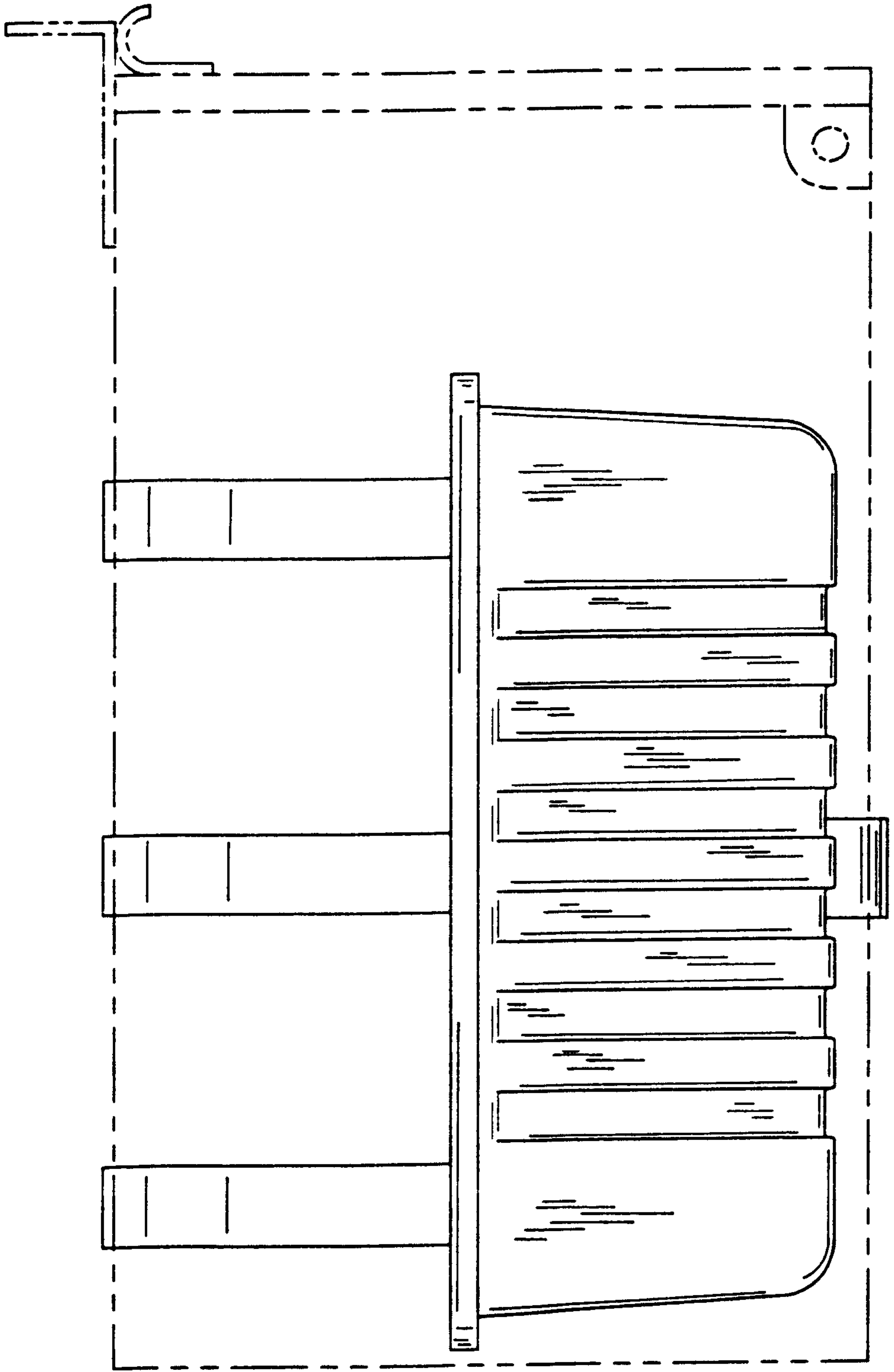
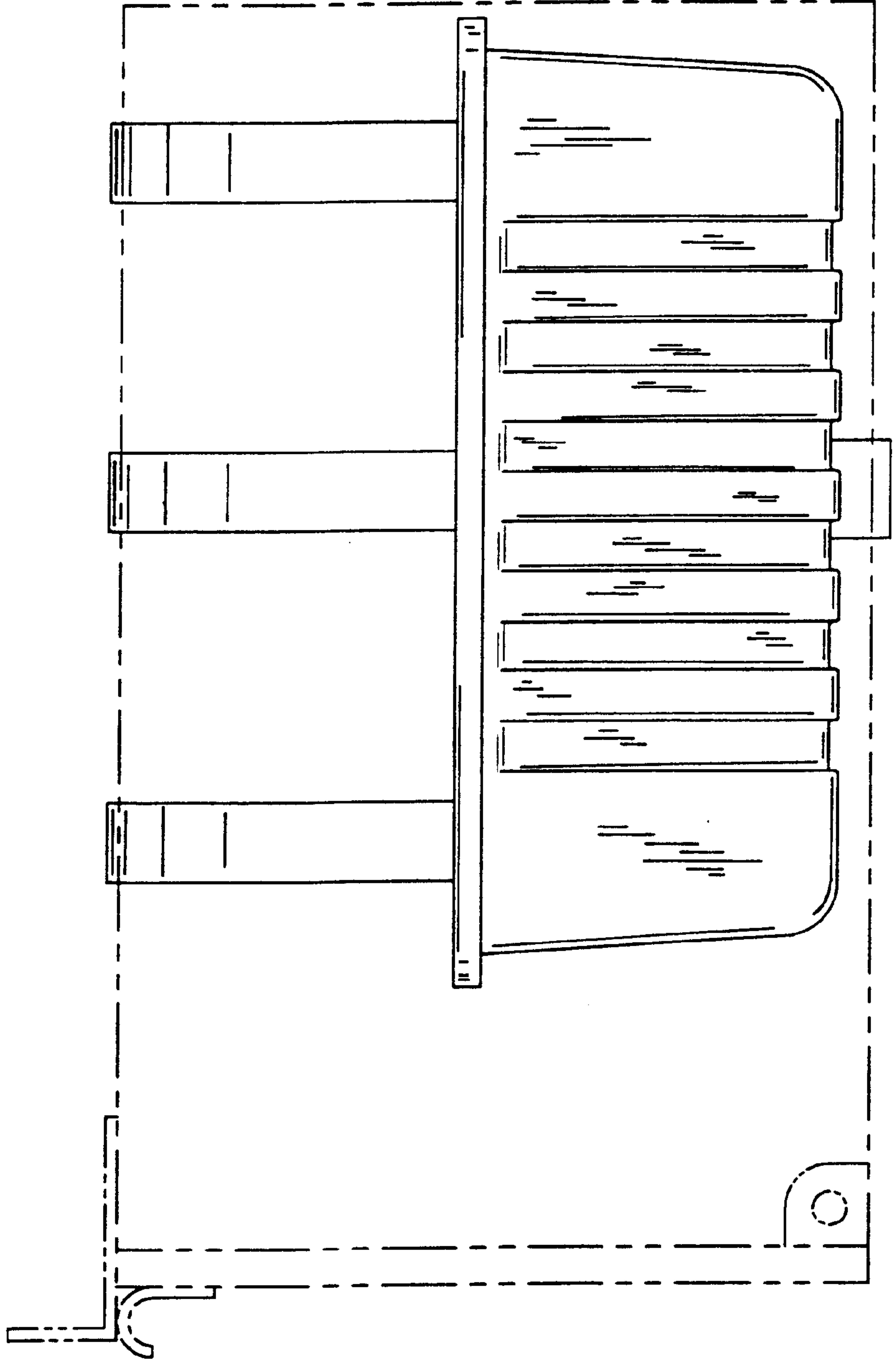

FIG. 11



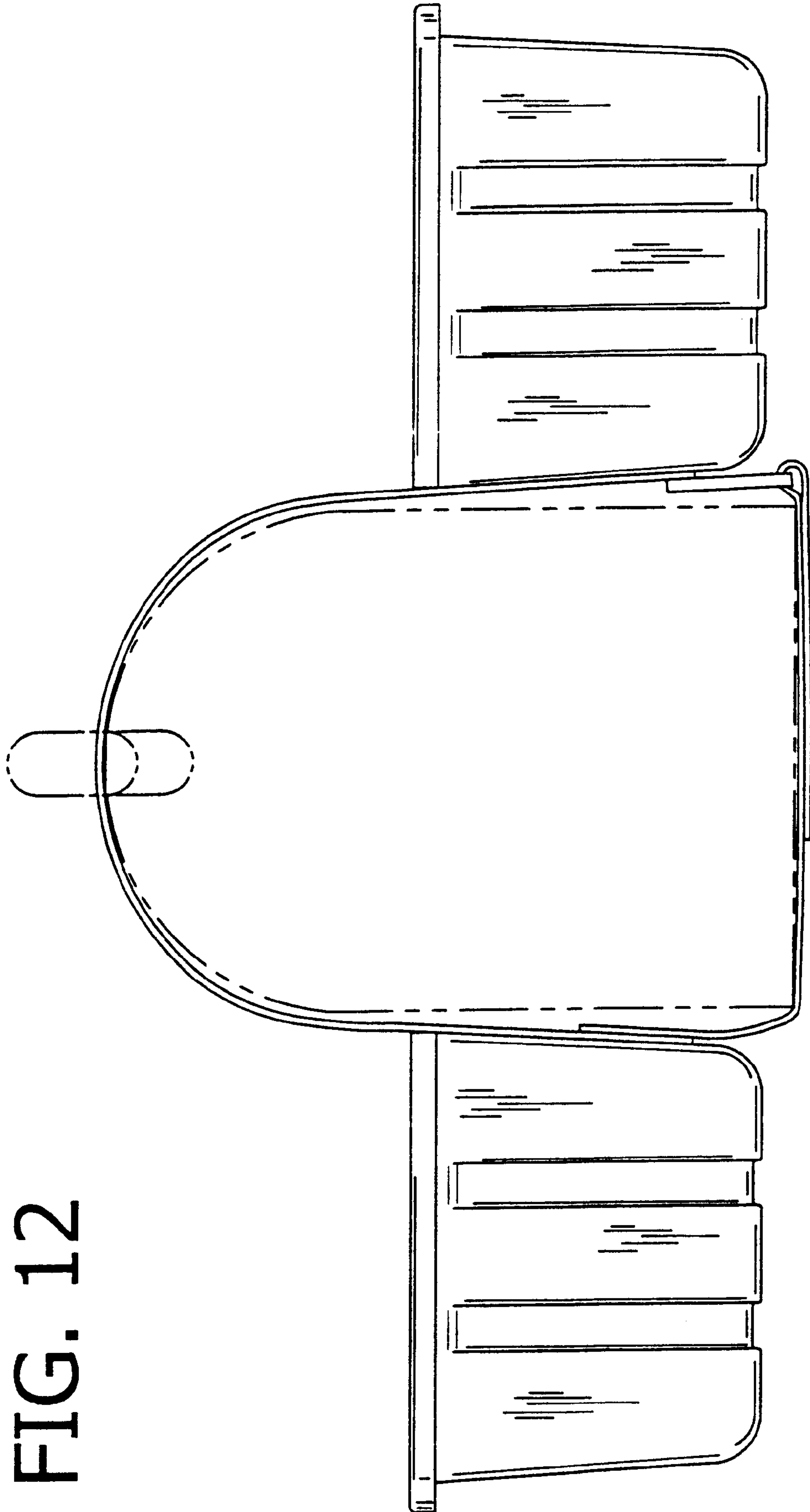

FIG. 12

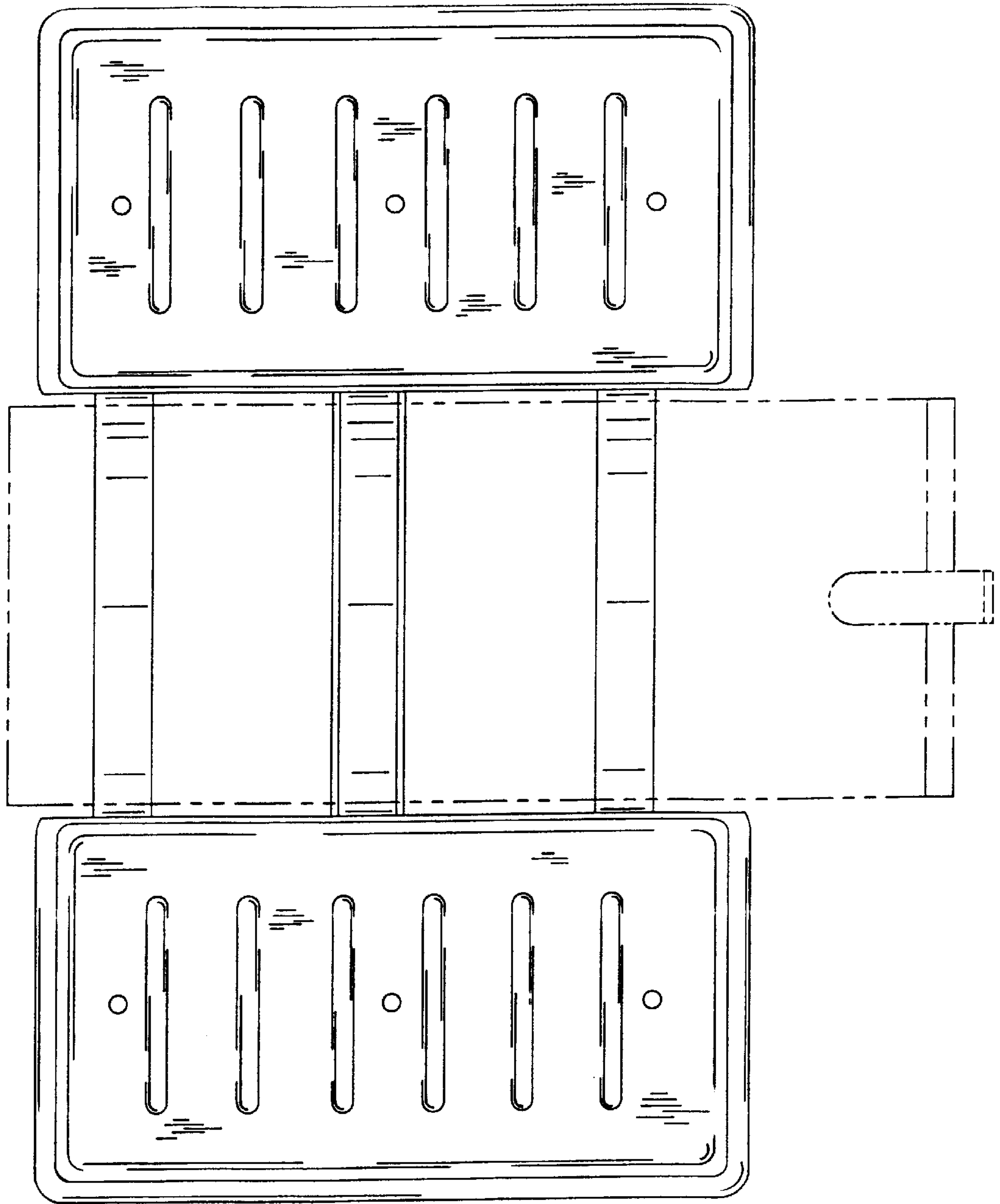

FIG. 13

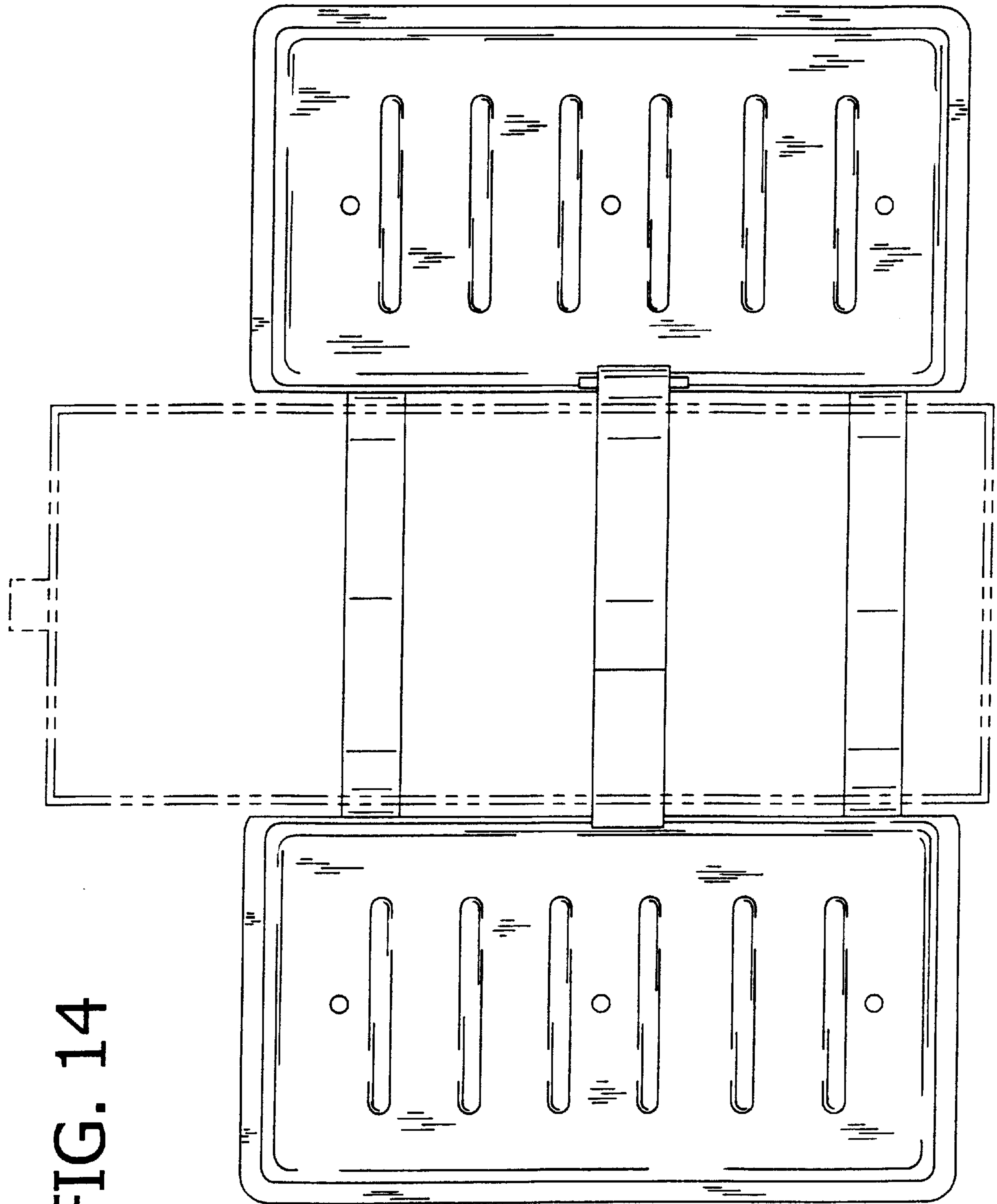

FIG. 14

FIG. 15

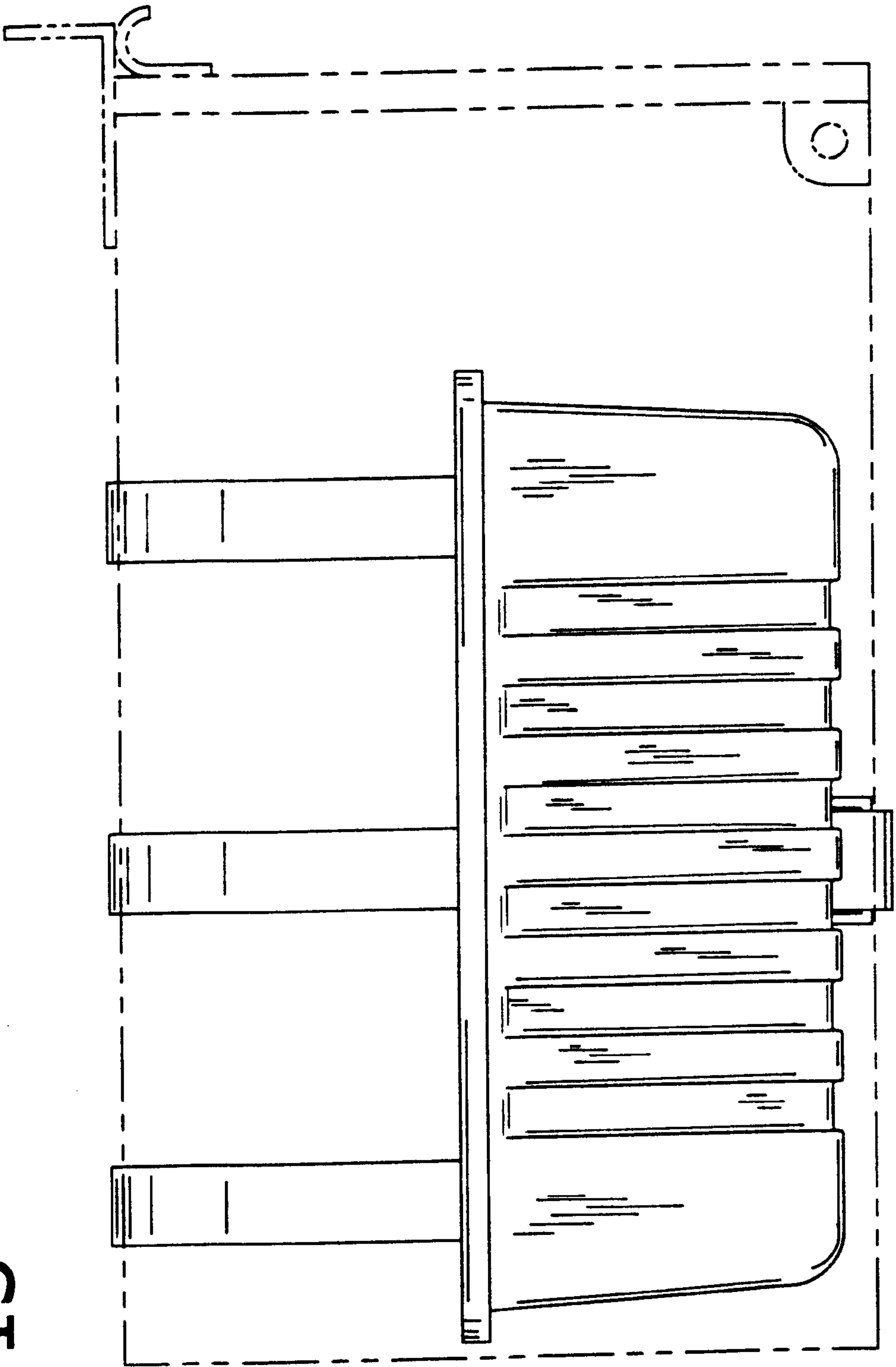

FIG. 16

