



US00D460566S

(12) **United States Design Patent**
Henschel et al.

(10) **Patent No.:** **US D460,566 S**
(45) **Date of Patent:** **** Jul. 16, 2002**

(54) **FOLDABLE STOOL**

(76) Inventors: **Reed E. Henschel**, 219 Main St., P.O. Box 337, Faith, SD (US) 57626; **Brad Eveleth**, Box 68-5 P.O. HC 59, Edgemont, SD (US) 57735

(**) Term: **14 Years**

(21) Appl. No.: **29/144,406**

(22) Filed: **Jul. 2, 2001**

(51) **LOC (7) Cl.** **25-04**

(52) **U.S. Cl.** **D25/65**

(58) **Field of Search** D25/65, 62, 63;
108/124, 129, 130, 131, 132; 16/DIG. 13;
297/44, 42, 188.1

(56) **References Cited**

U.S. PATENT DOCUMENTS

1,970,196 A	8/1934	Rodemeyer	
3,077,282 A	2/1963	Eggers	
3,673,636 A	7/1972	Ruiz	
4,043,277 A *	8/1977	Wallace	108/35
4,253,268 A	3/1981	Mayr	
D265,026 S *	6/1982	Macho et al.	D6/353
4,383,488 A	5/1983	Macho et al.	
4,630,861 A	12/1986	Henschel	
4,807,329 A	2/1989	Mossalgue	
5,361,456 A	11/1994	Newby, Sr.	
5,697,669 A	12/1997	Yemini	
5,845,366 A	12/1998	Kuroda	
5,940,934 A	8/1999	Turner	

* cited by examiner

Primary Examiner—Stella Reid

(74) *Attorney, Agent, or Firm*—Kinney & Lange, P.A.

(57) **CLAIM**

The ornamental design for a foldable stool, as shown and described.

DESCRIPTION

FIG. 1 is a perspective view of the present invention in an open position;
 FIG. 2 is a top plan view of the present invention in an open position;
 FIG. 3 is a front elevational view of the present invention in an open position;
 FIG. 4 is a right side view of the present invention in an open position;
 FIG. 5 is a rear elevational view of the present invention in an open position;
 FIG. 6 is a left side view of the present invention in an open position;
 FIG. 7 is a bottom plan view of the present invention in an open position;
 FIG. 8 is a perspective view of the present invention in a folded or collapsed position;
 FIG. 9 is a top plan view of the present invention in a folded or collapsed position;
 FIG. 10 is a front elevational view of the present invention in a folded or collapsed position;
 FIG. 11 is a right side view of the present invention in a folded or collapsed position;
 FIG. 12 is a rear elevational view of the present invention in a folded or collapsed position;
 FIG. 13 is a left side view of the present invention in a folded or collapsed position; and,
 FIG. 14 is a bottom plan view of the present invention in a folded or collapsed position.

1 Claim, 13 Drawing Sheets

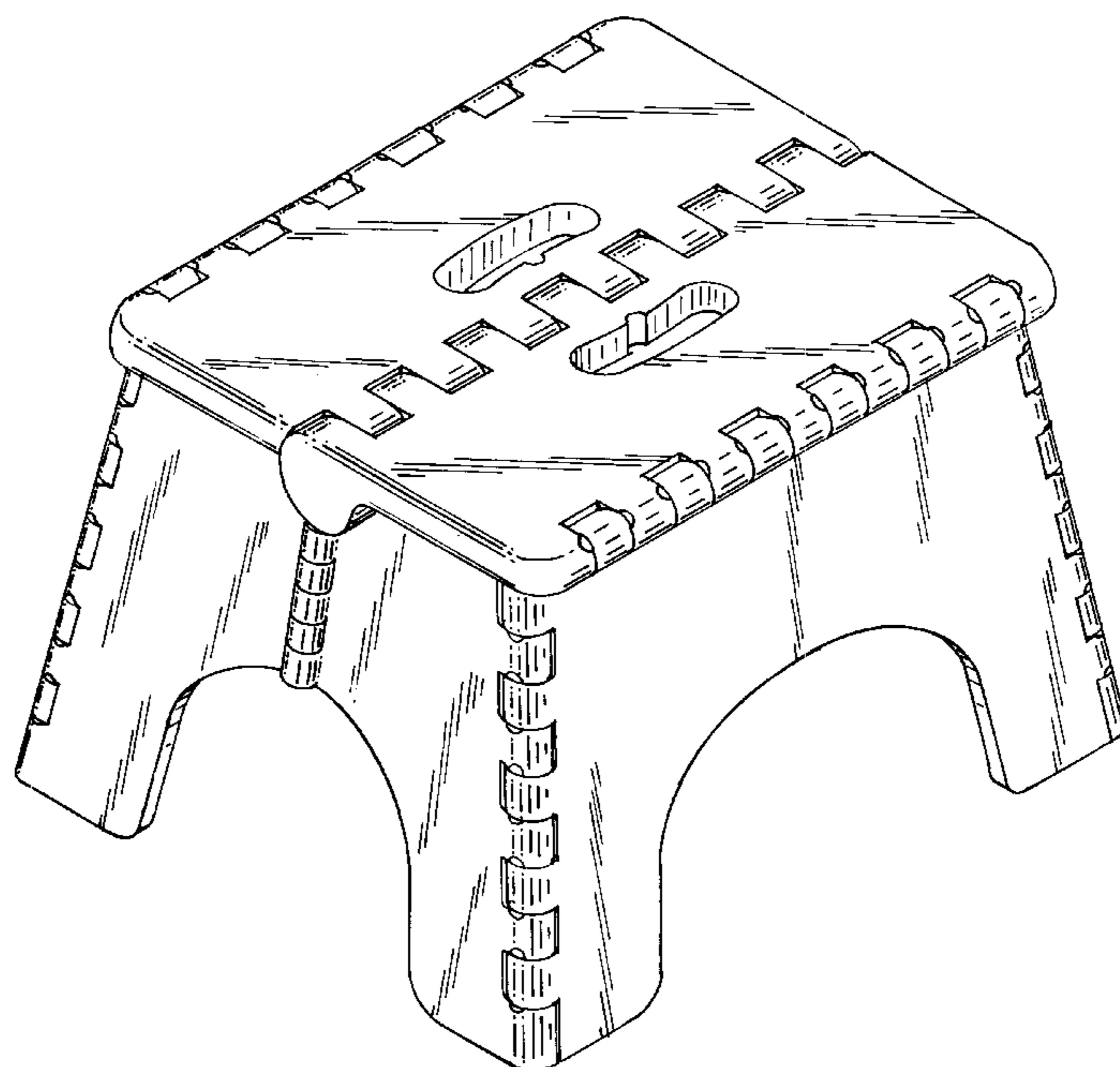

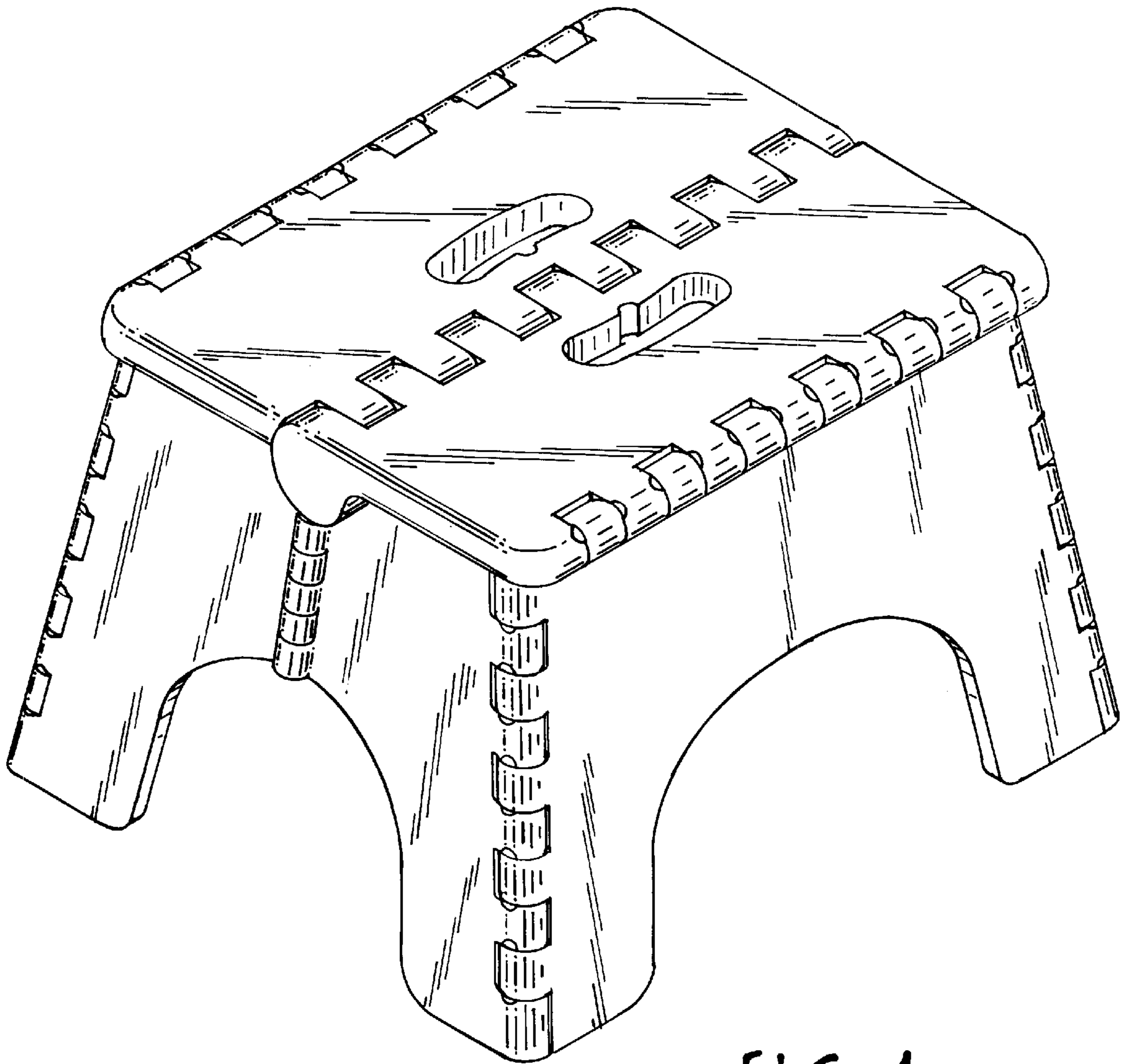

FIG. 1

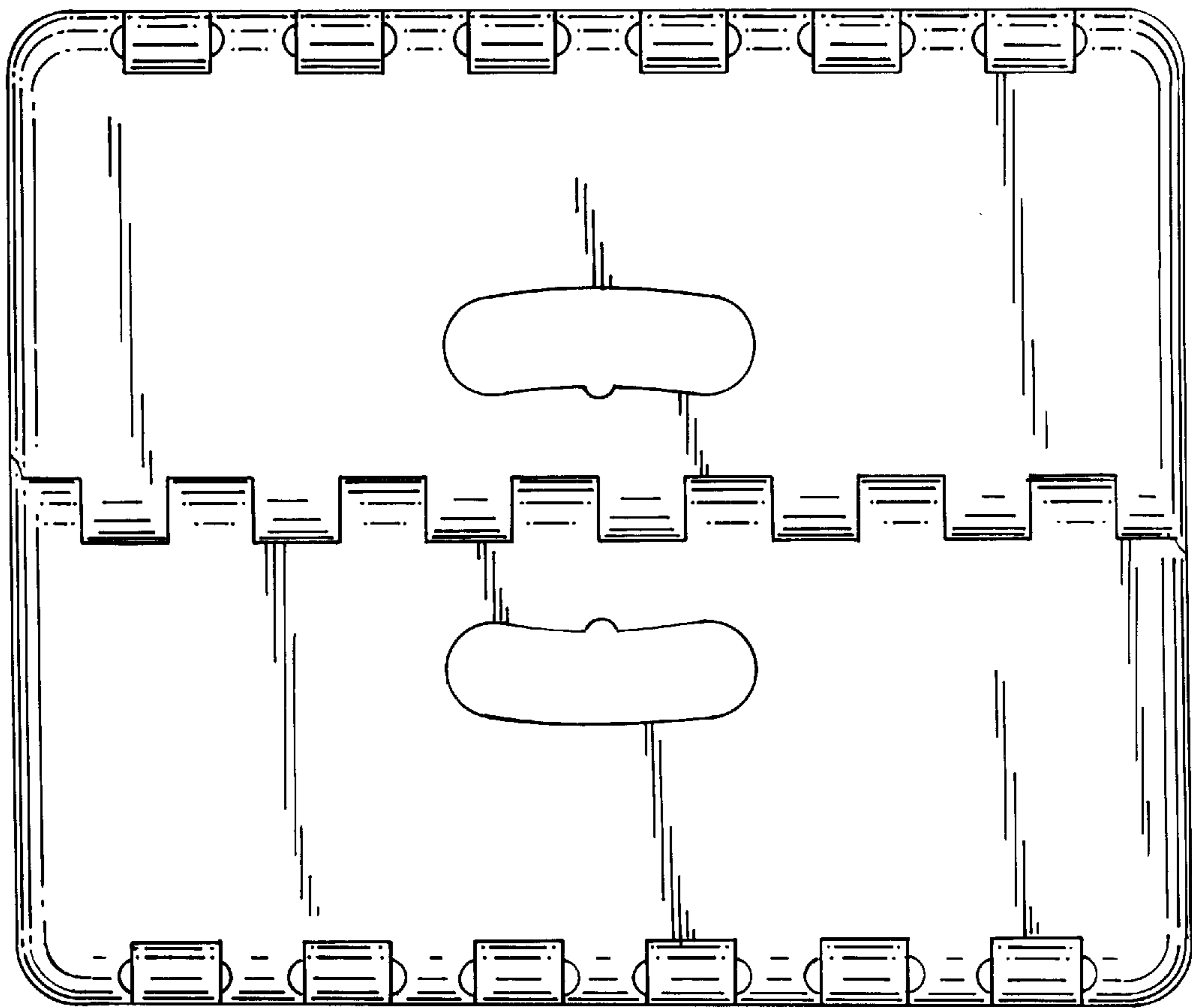

FIG. 2

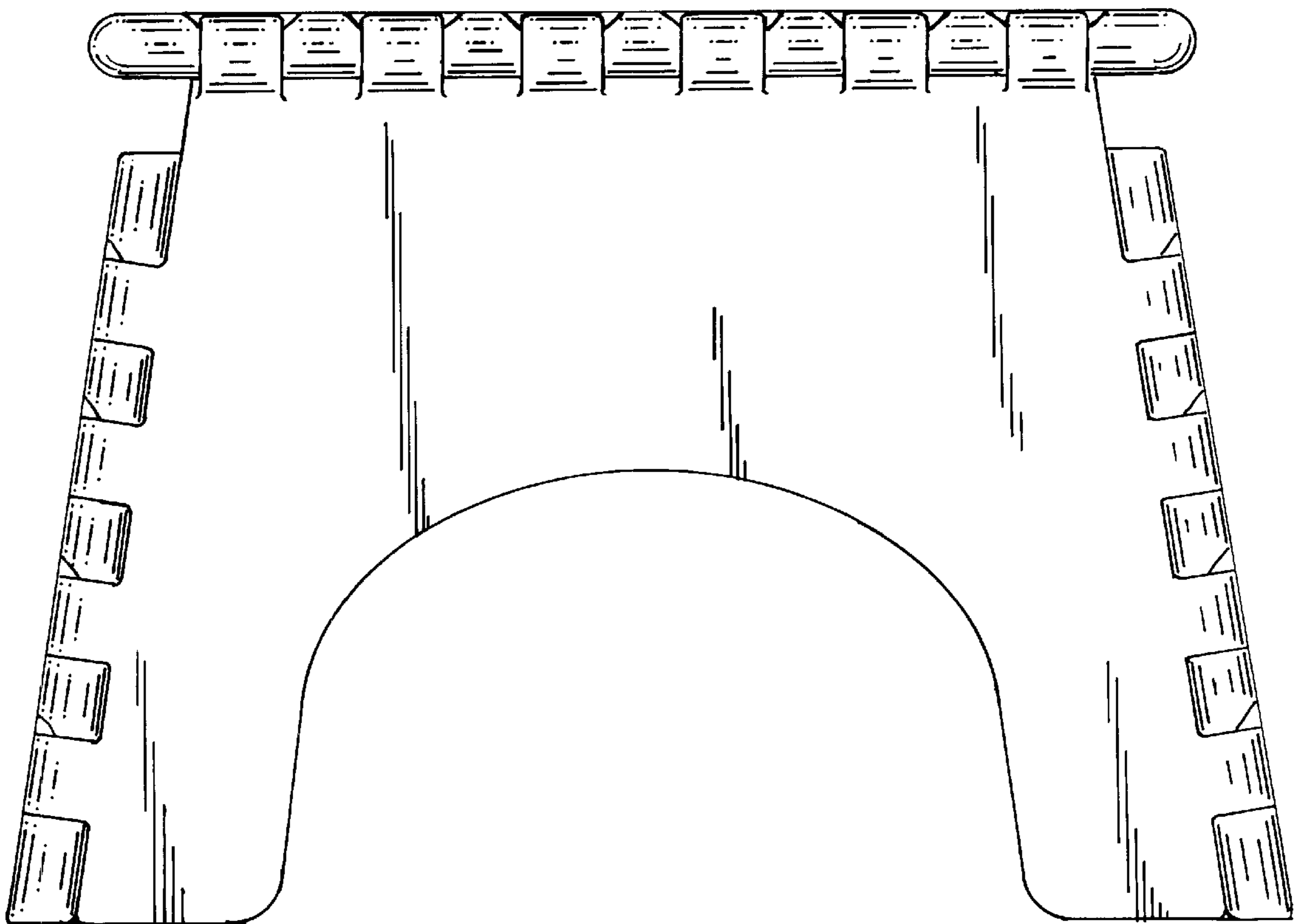

FIG. 3

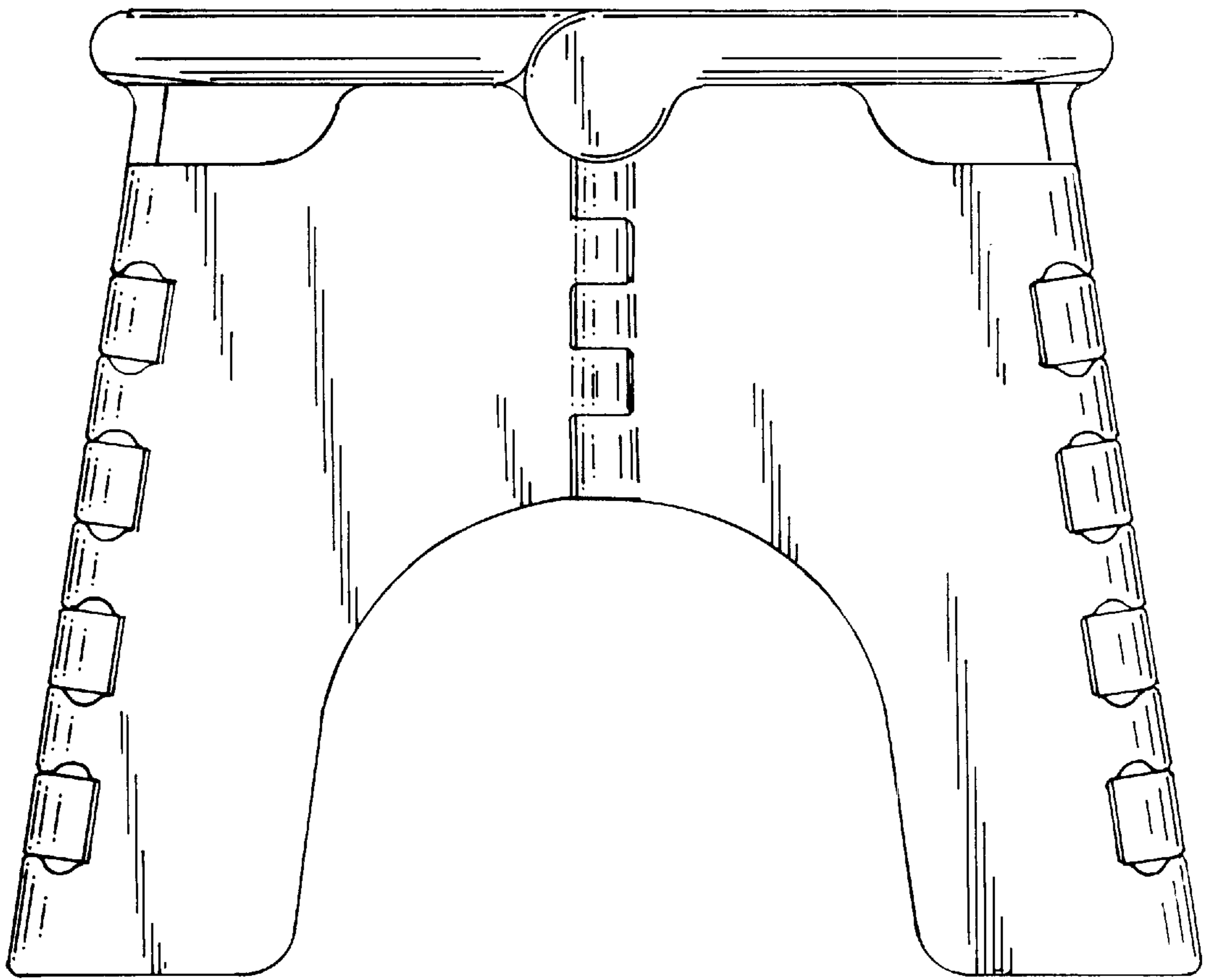

FIG. 4

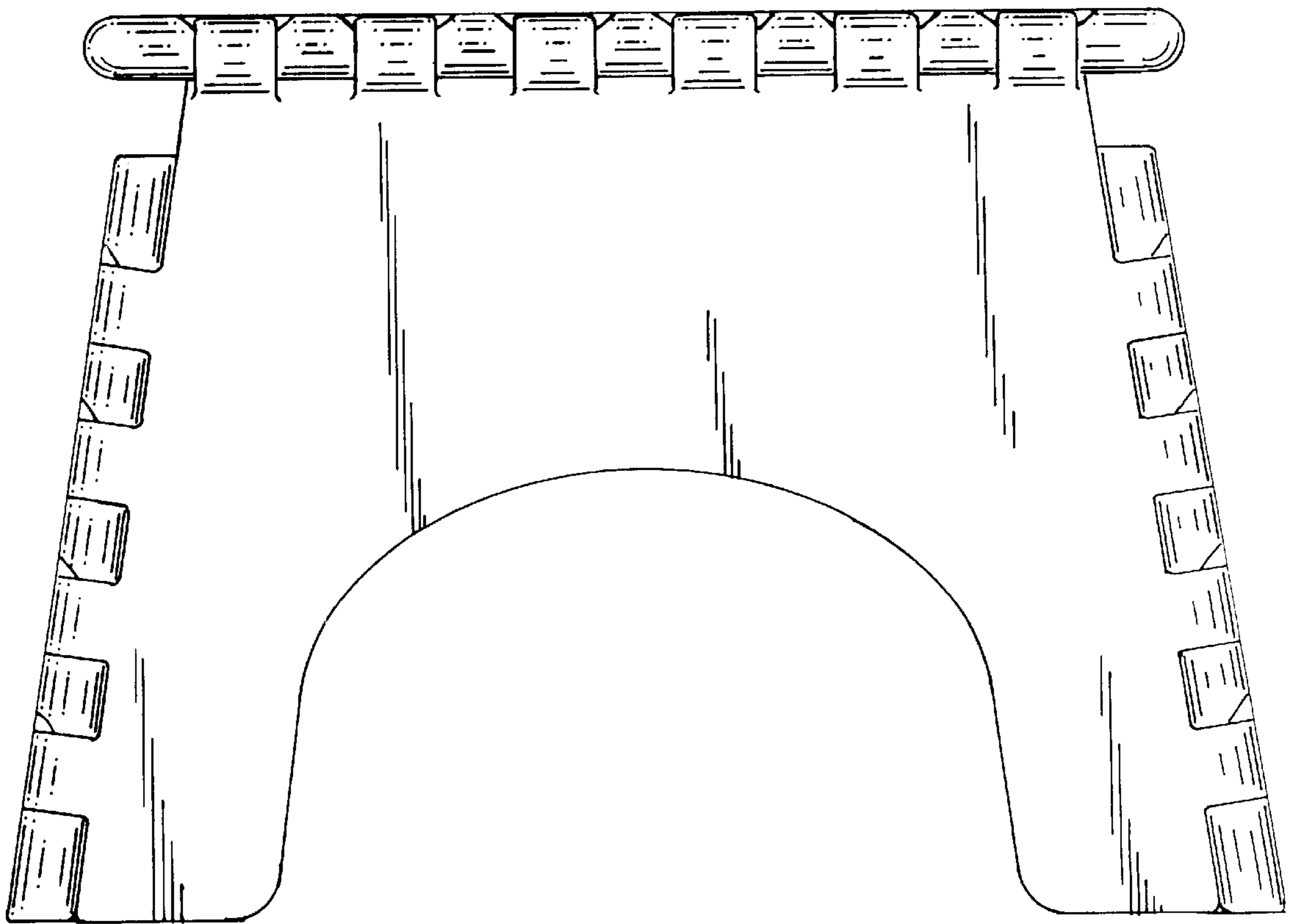

FIG. 5

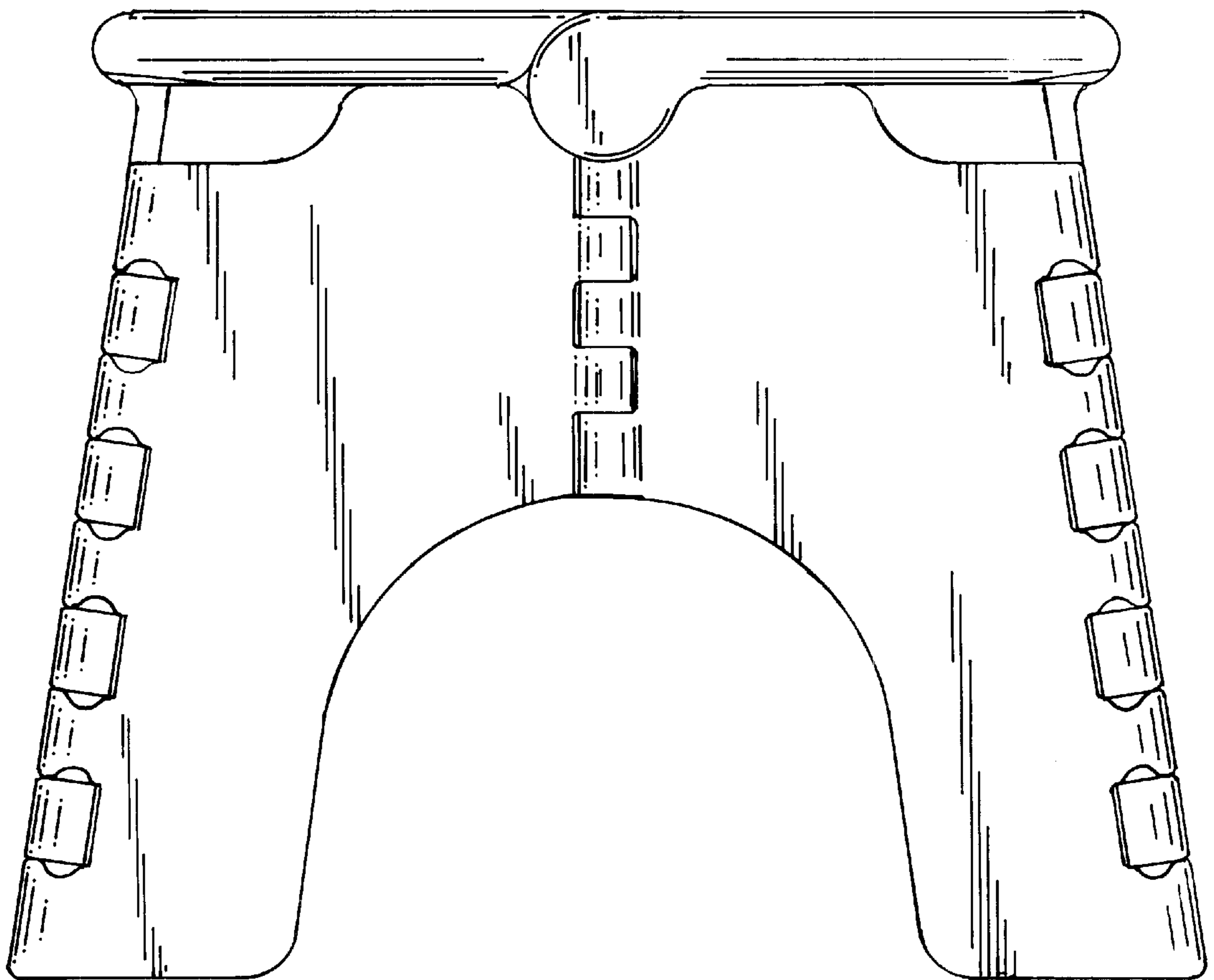

FIG. 6

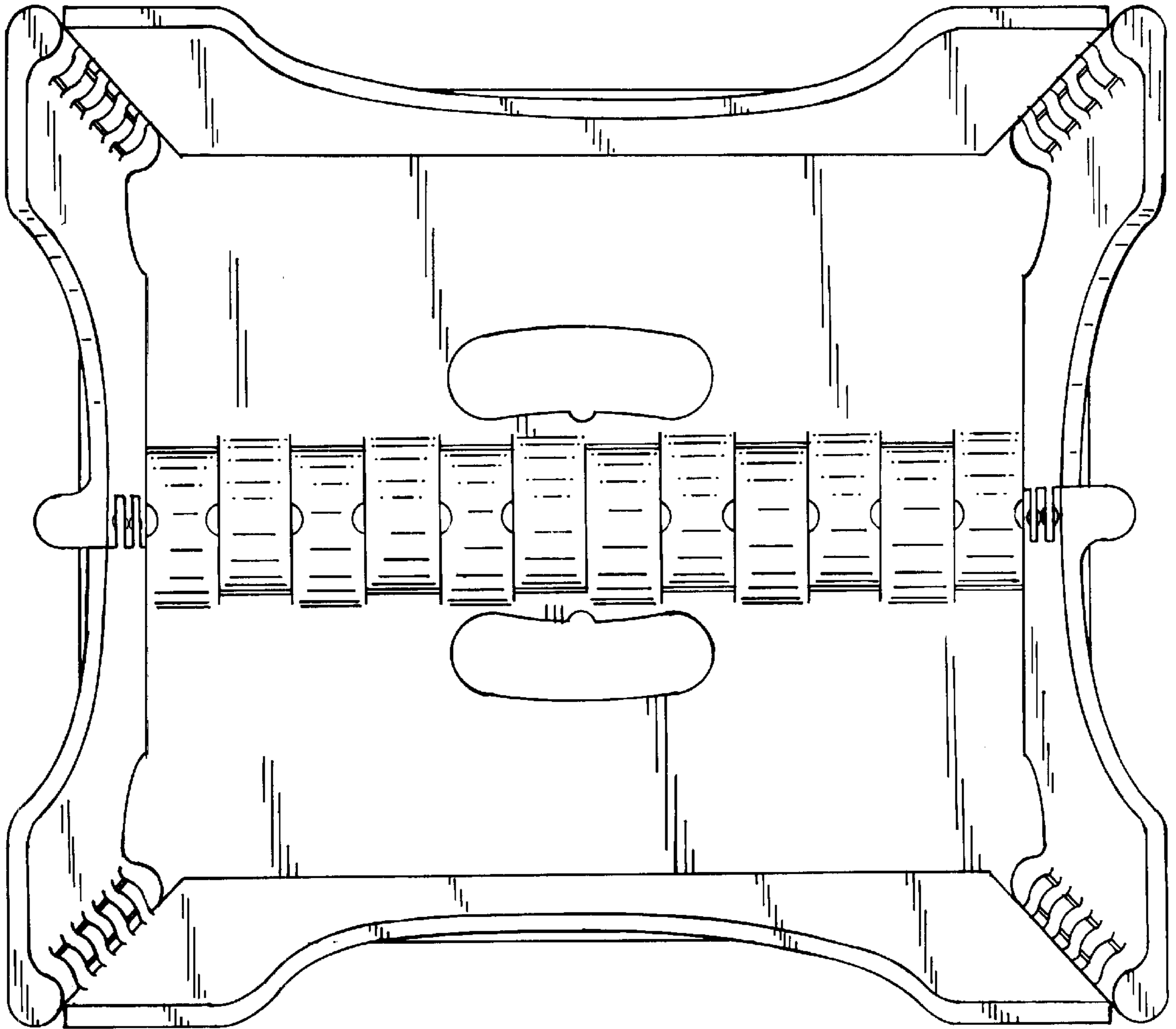
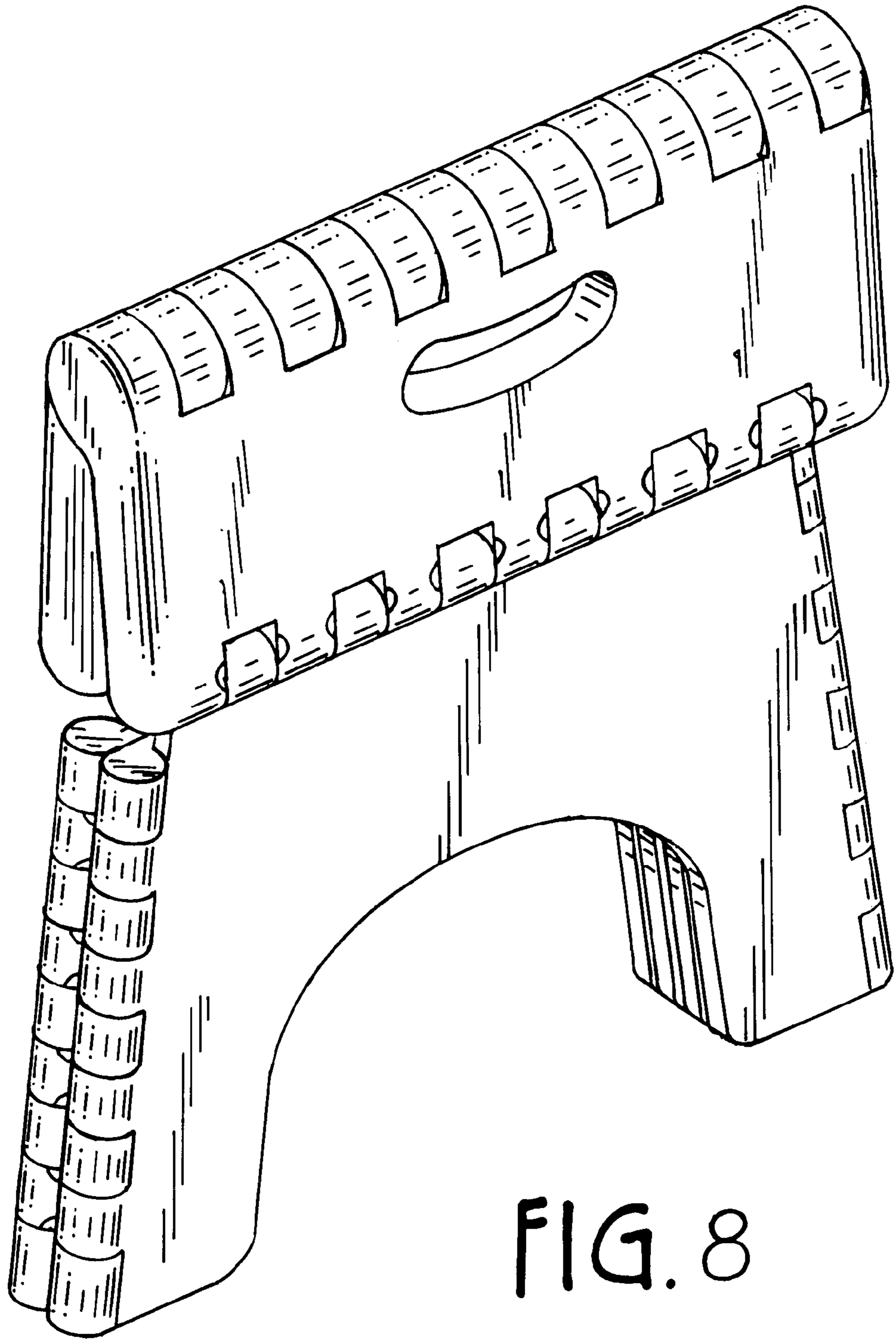

FIG. 7



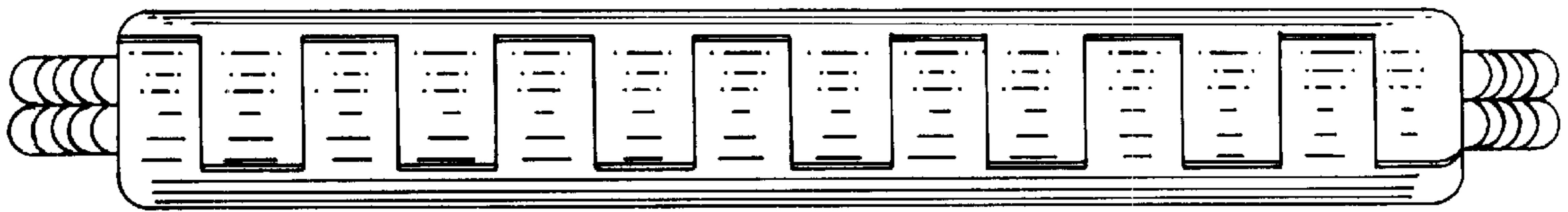

FIG. 9

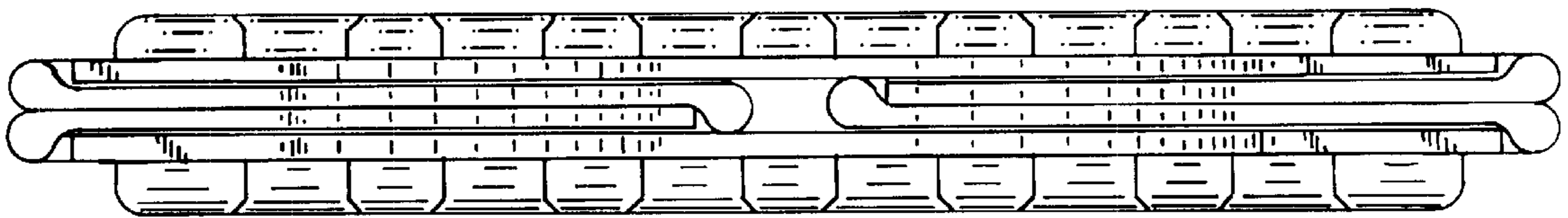

FIG. 14

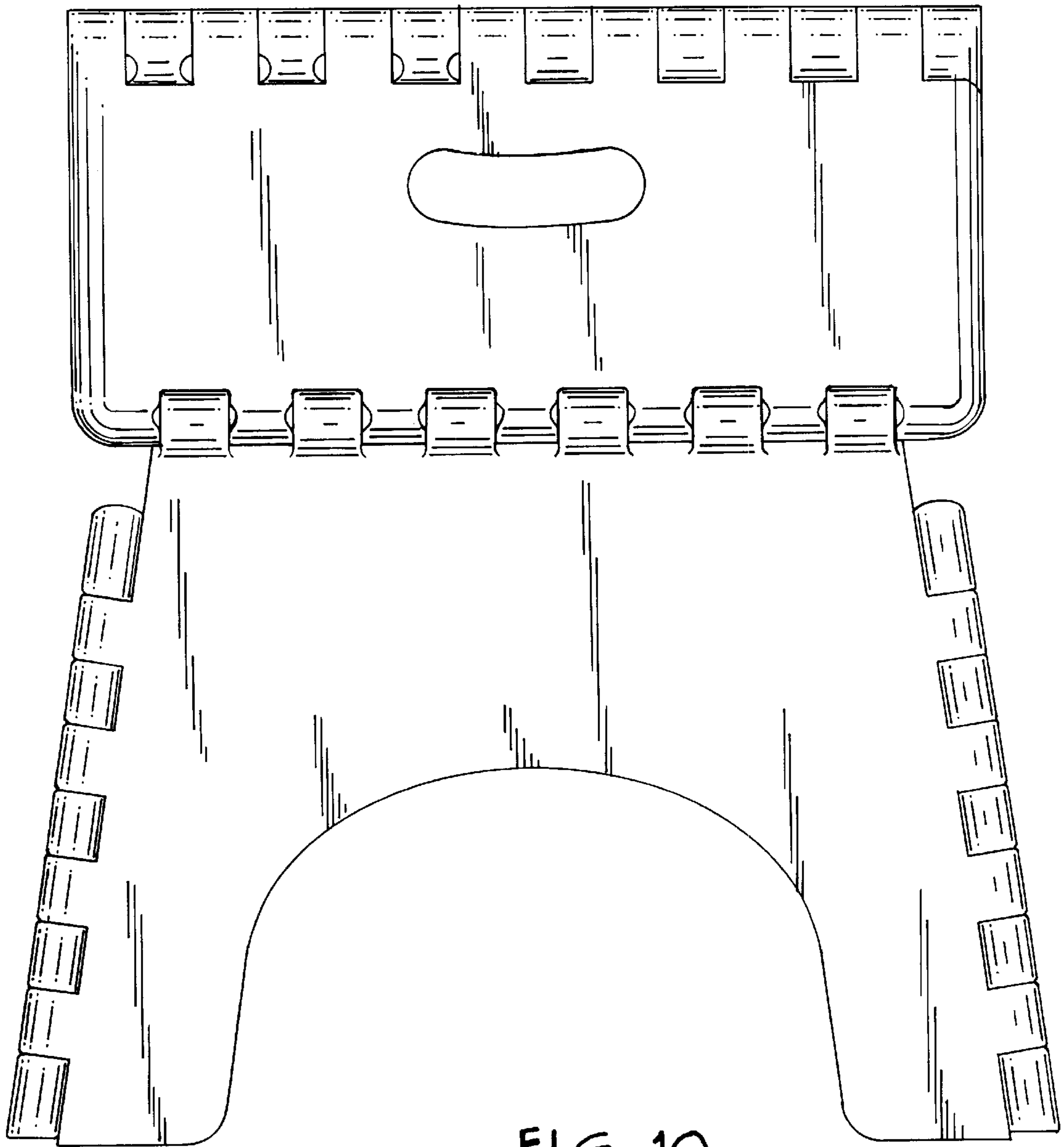

FIG. 10

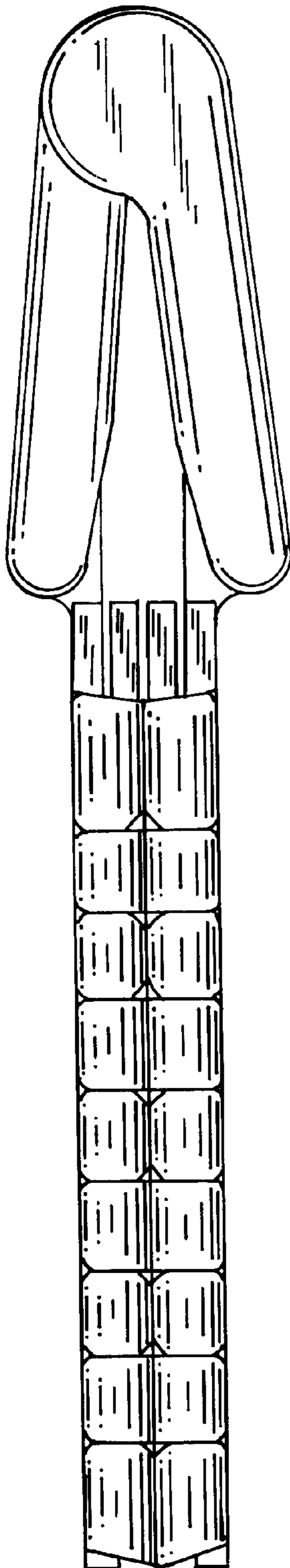

FIG. 11

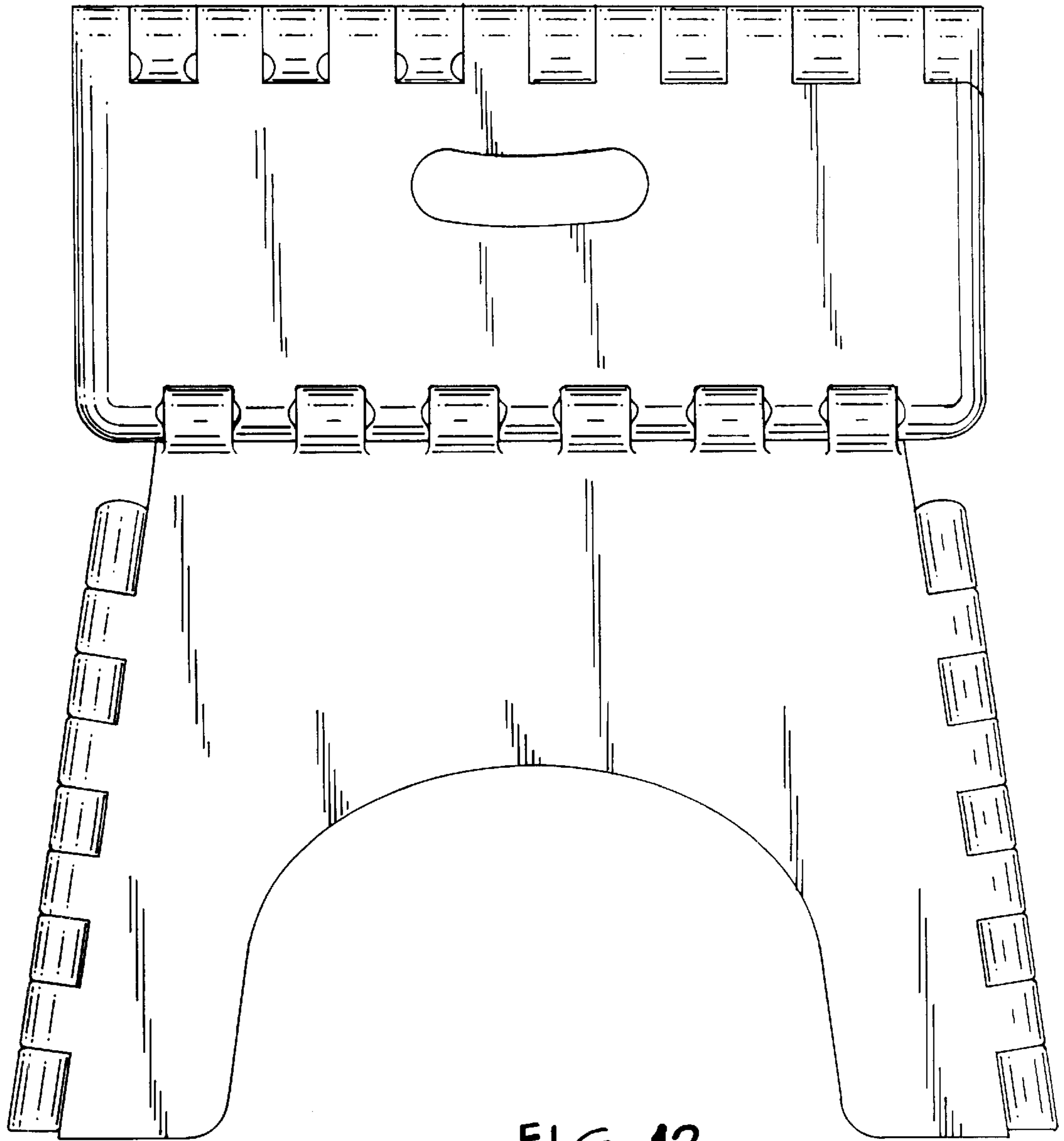

FIG. 12

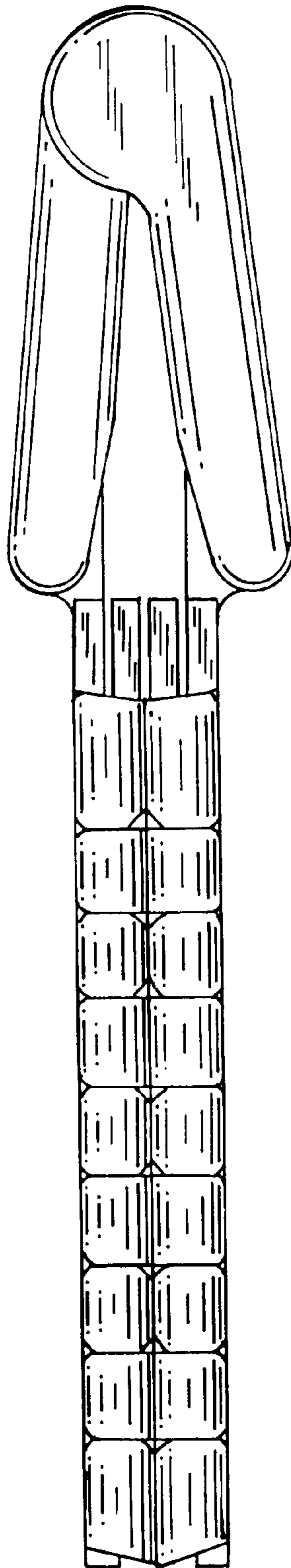

FIG. 13