



US00D460344S

(12) **United States Design Patent**  
**Smith**

(10) **Patent No.:** **US D460,344 S**

(45) **Date of Patent:** **\*\* Jul. 16, 2002**

(54) **UNIVERSAL CLUSTER TIE DOWN STRAP**

D407,965 S 4/1999 Smith

D411,099 S 6/1999 Smith

D427,506 S 7/2000 Smith

(75) Inventor: **Lonnie M. Smith**, St. Louis County,  
MO (US)

\* cited by examiner

(73) Assignee: **S&J Metal Manufacturing, Inc.**,  
Cuba, MO (US)

*Primary Examiner*—Pamela Burgess

(74) *Attorney, Agent, or Firm*—Paul M. Denk

(\*\*) Term: **14 Years**

(57) **CLAIM**

(21) Appl. No.: **29/136,951**

The ornamental design for a universal cluster tie down strap,  
as shown and described.

(22) Filed: **Feb. 9, 2001**

**DESCRIPTION**

(51) **LOC (7) Cl.** ..... **08-05**

(52) **U.S. Cl.** ..... **D8/367**

(58) **Field of Search** ..... D8/367, 373; 248/499,  
248/301–304, 339; D6/323

FIG. 1 is a front elevational view of a universal cluster tie  
down strap showing my new design;  
FIG. 2 is a rear elevational view thereof;  
FIG. 3 is a right side view thereof;  
FIG. 4 is a left side view thereof;  
FIG. 5 is a bottom view thereof; and,  
FIG. 6 is a top view of the invention.

(56) **References Cited**

**U.S. PATENT DOCUMENTS**

- |               |        |         |               |
|---------------|--------|---------|---------------|
| 1,073,226 A   | 9/1913 | Freeman |               |
| 3,229,952 A * | 1/1966 | Zumbo   | ..... 248/499 |
| D273,176 S    | 3/1984 | Abbott  |               |

It is understood that the irregular break lines in the claimed  
design are shown to indicate indeterminate length.

**1 Claim, 4 Drawing Sheets**

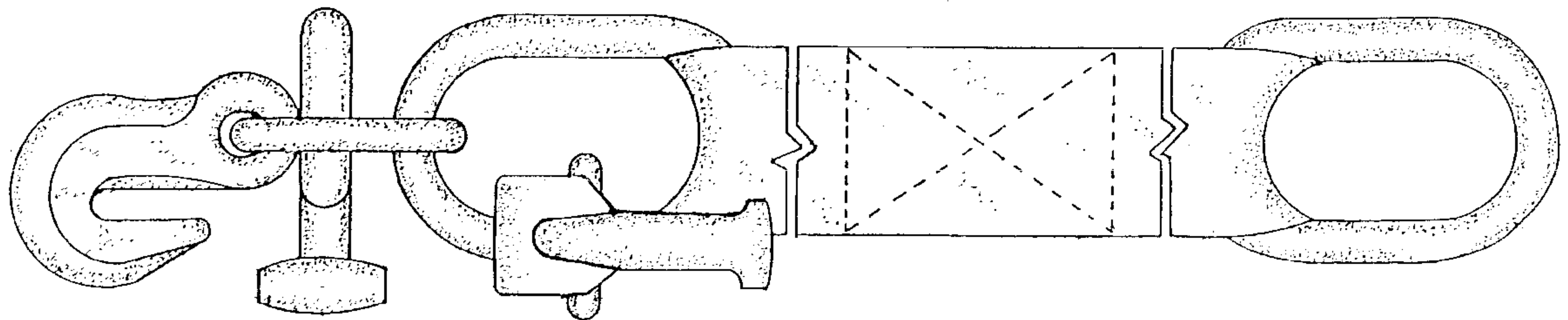

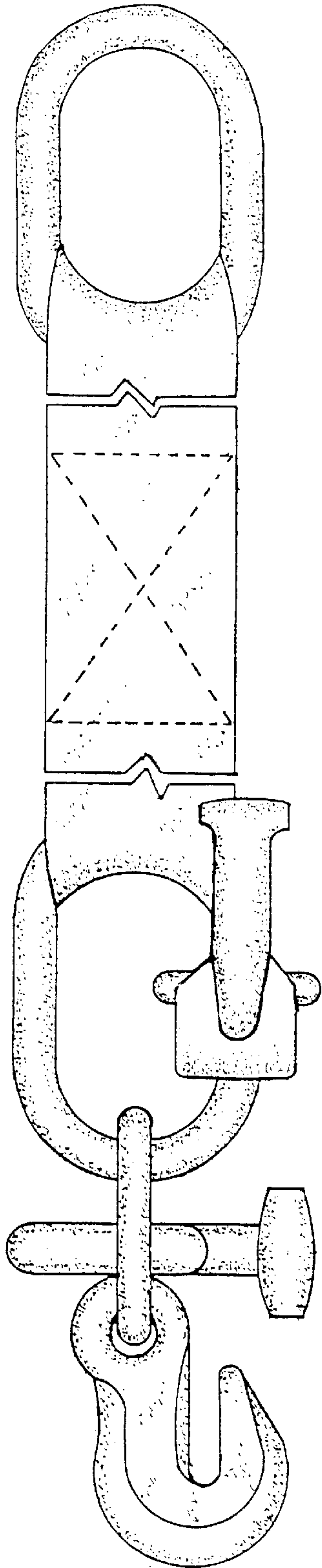

FIG. 1

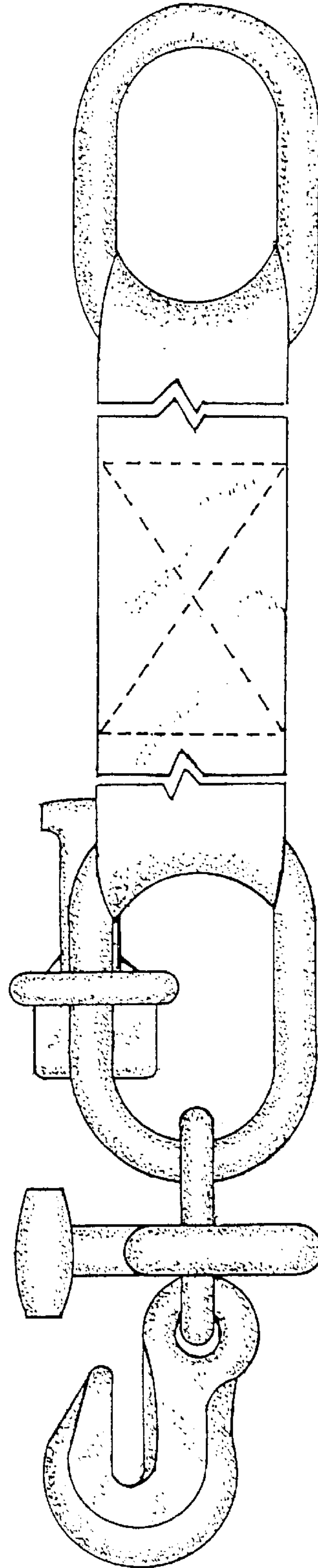

FIG. 2

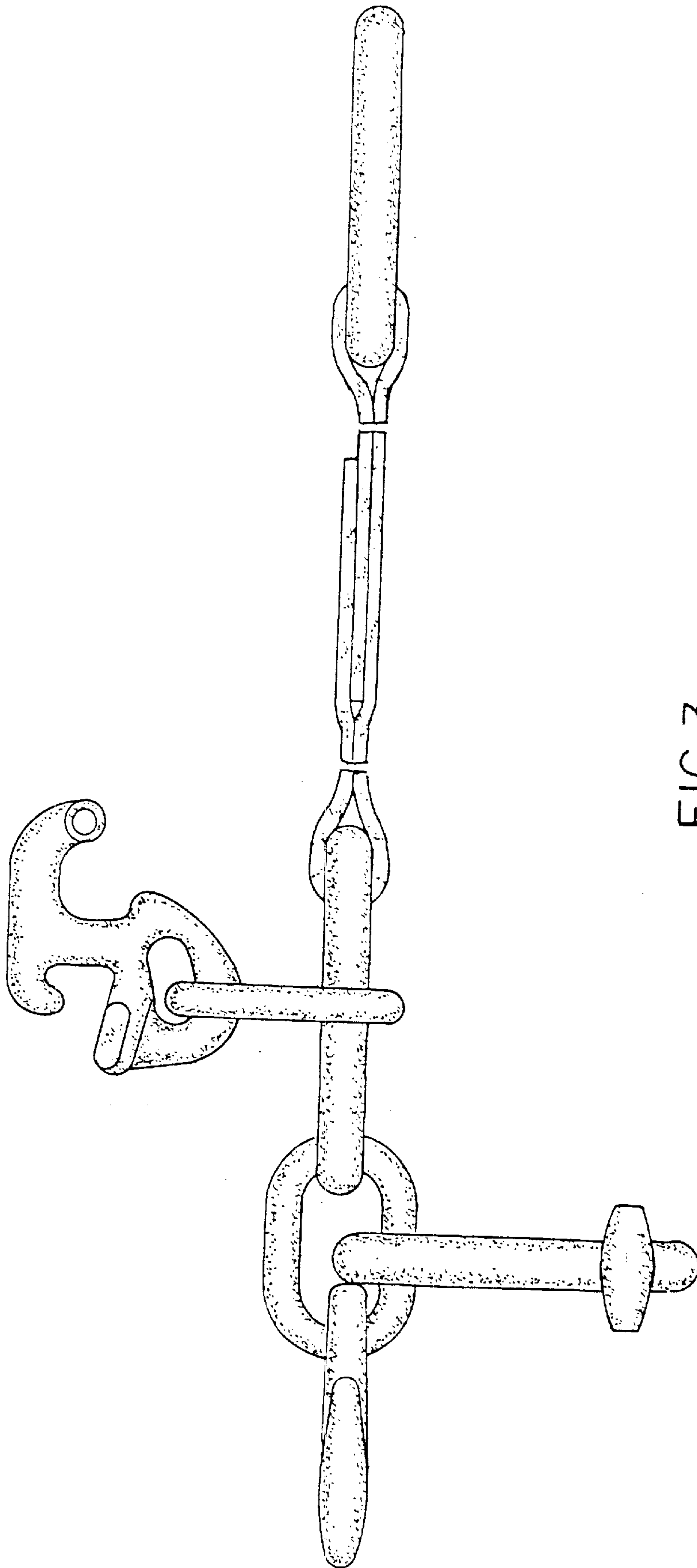

FIG. 3

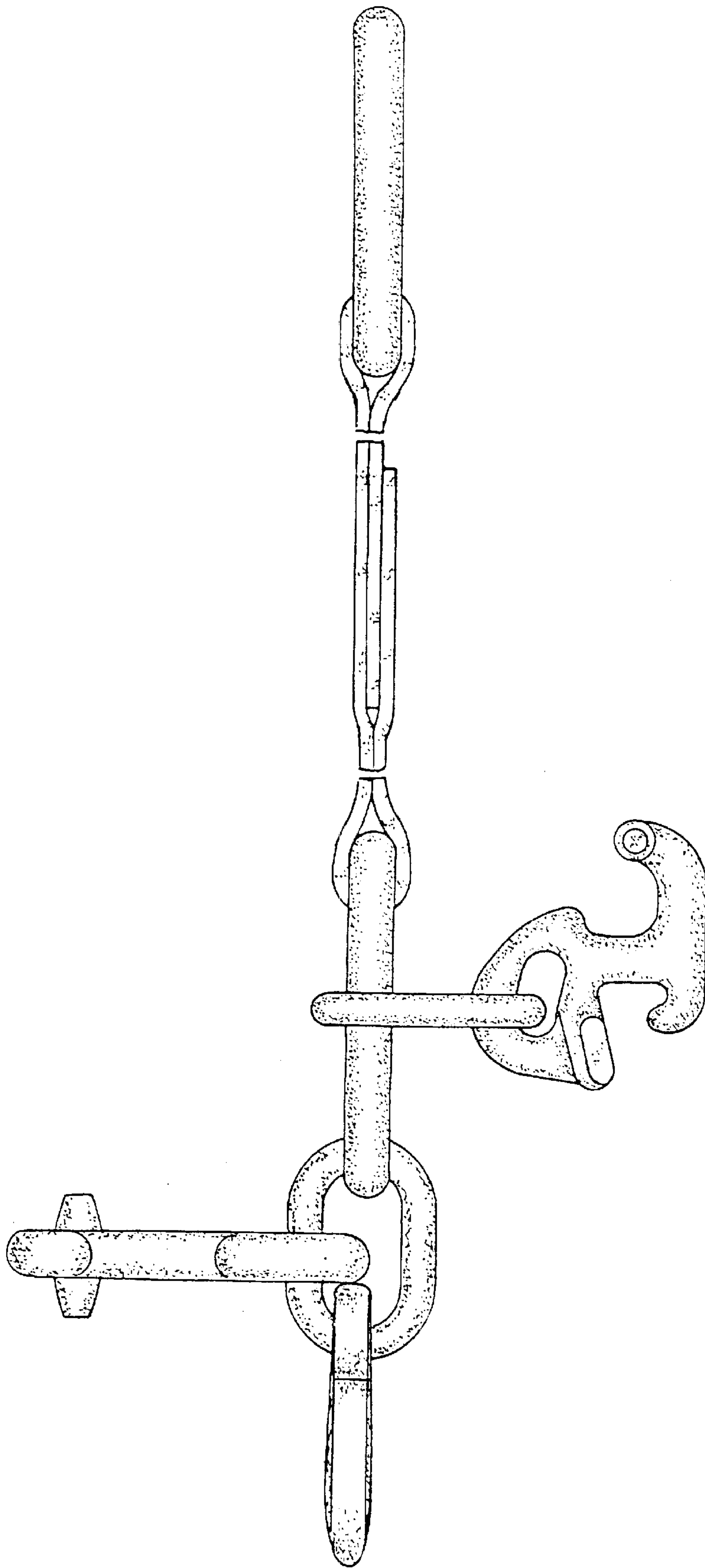

FIG. 4

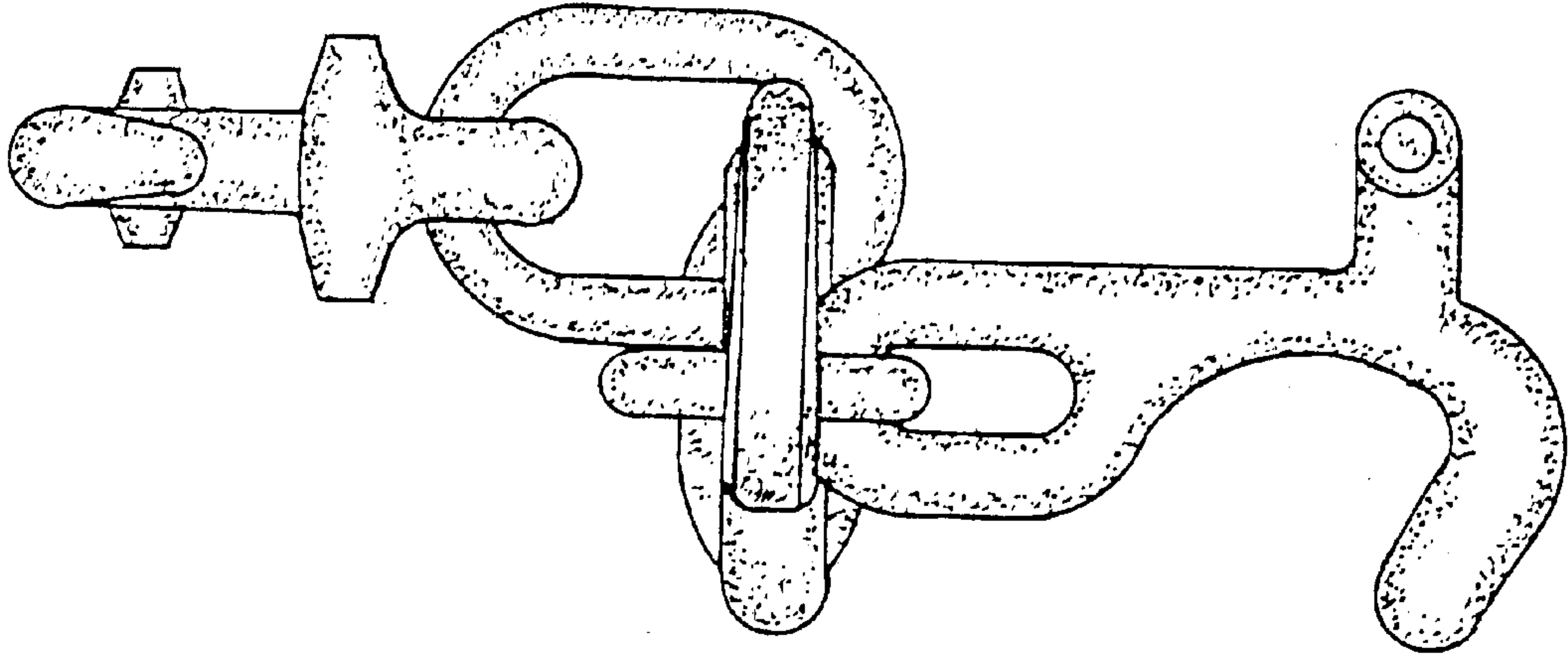

FIG. 5

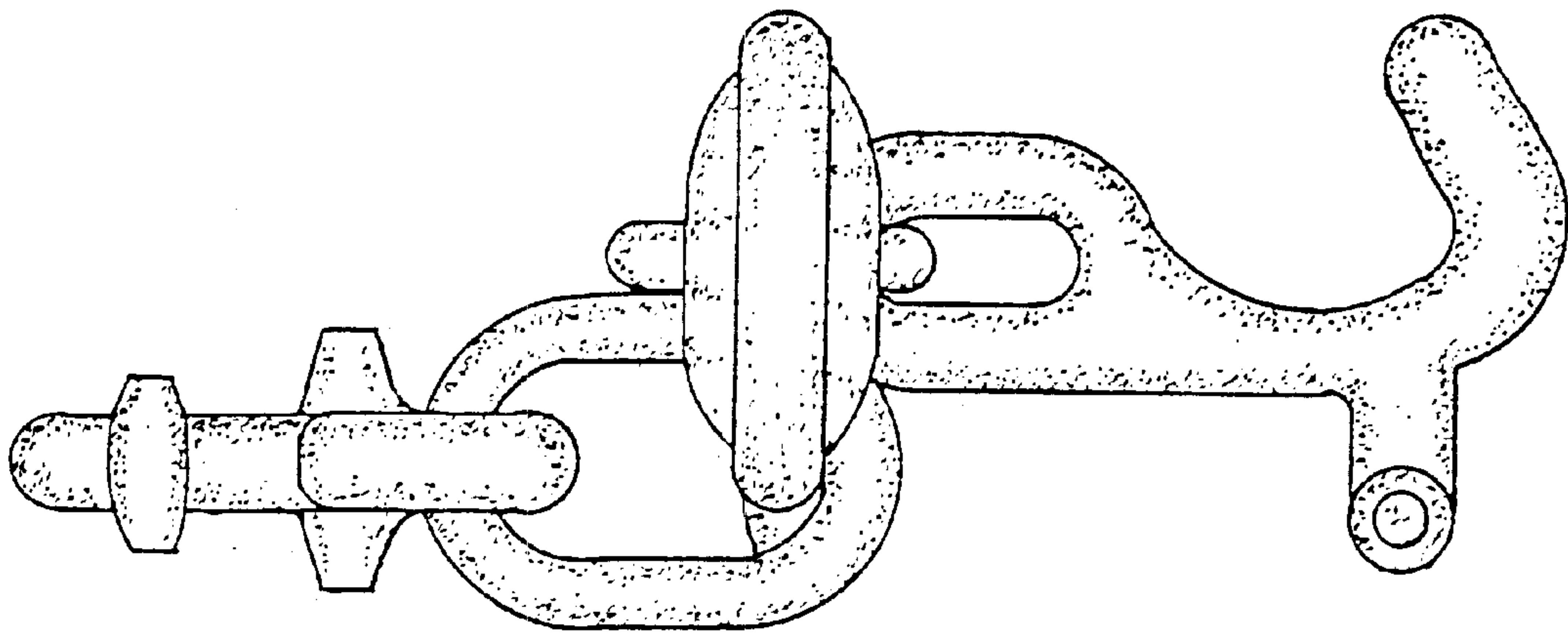

FIG. 6