



US00D460243S

(12) **United States Design Patent**
Park

(10) **Patent No.:** **US D460,243 S**

(45) **Date of Patent:** **** Jul. 16, 2002**

(54) **SUN VISOR FOR LADY**

(75) Inventor: **Boo Yi Park**, Seoul (KR)

(73) Assignee: **DADA Corp.**, Seoul (KR)

(**) Term: **14 Years**

(21) Appl. No.: **29/140,606**

(22) Filed: **Apr. 23, 2001**

(51) **LOC (7) Cl.** **02-03**

(52) **U.S. Cl.** **D2/872**

(58) **Field of Search** D2/865, 868, 869,
D2/871, 872, 873, 875, 876, 879, 882;
2/12, 171, 174, 181, 195.1, DIG. 11, 200.3;
D29/100, 109

(56) **References Cited**

U.S. PATENT DOCUMENTS

- 2,629,869 A * 3/1953 Locken 2/174 X
- 4,247,957 A 2/1981 Rogers
- 4,258,437 A 3/1981 Sawatsky
- 4,277,847 A * 7/1981 Florio 2/12
- 4,606,077 A * 8/1986 Phillips 2/12
- 4,670,910 A 6/1987 Rosasco
- 4,945,575 A 8/1990 Townsend
- 5,577,520 A * 11/1996 Sluder 2/12 X
- 5,692,235 A 12/1997 Fields

- 5,903,921 A * 5/1999 Dow 2/12
- D415,605 S * 10/1999 Ae D2/876
- 6,199,213 B1 * 3/2001 Whang 2/181

* cited by examiner

Primary Examiner—Paula A. Mortimer

(57) **CLAIM**

The ornamental design for a sun visor for lady, as shown.

DESCRIPTION

FIG. 1 is a perspective view of a sun visor for lady showing my new design;
 FIG. 2 is a top plan view of FIG. 1;
 FIG. 3 is a front elevational view of FIG. 1;
 FIG. 4 is a right side elevational view of FIG. 1;
 FIG. 5 is a left side elevational view of FIG. 1;
 FIG. 6 is a rear elevational view of FIG. 1;
 FIG. 7 is a bottom plan view of FIG. 1.
 FIG. 8 is a perspective view of a second embodiment of a sun visor for lady showing my new design;
 FIG. 9 is a top plan view of FIG. 8;
 FIG. 10 is a front elevational view of FIG. 8;
 FIG. 11 is a right side elevational view of FIG. 8;
 FIG. 12 is a left side elevational view of FIG. 8;
 FIG. 13 is a rear elevational view of FIG. 8; and,
 FIG. 14 is a bottom plan view of FIG. 8.

1 Claim, 8 Drawing Sheets

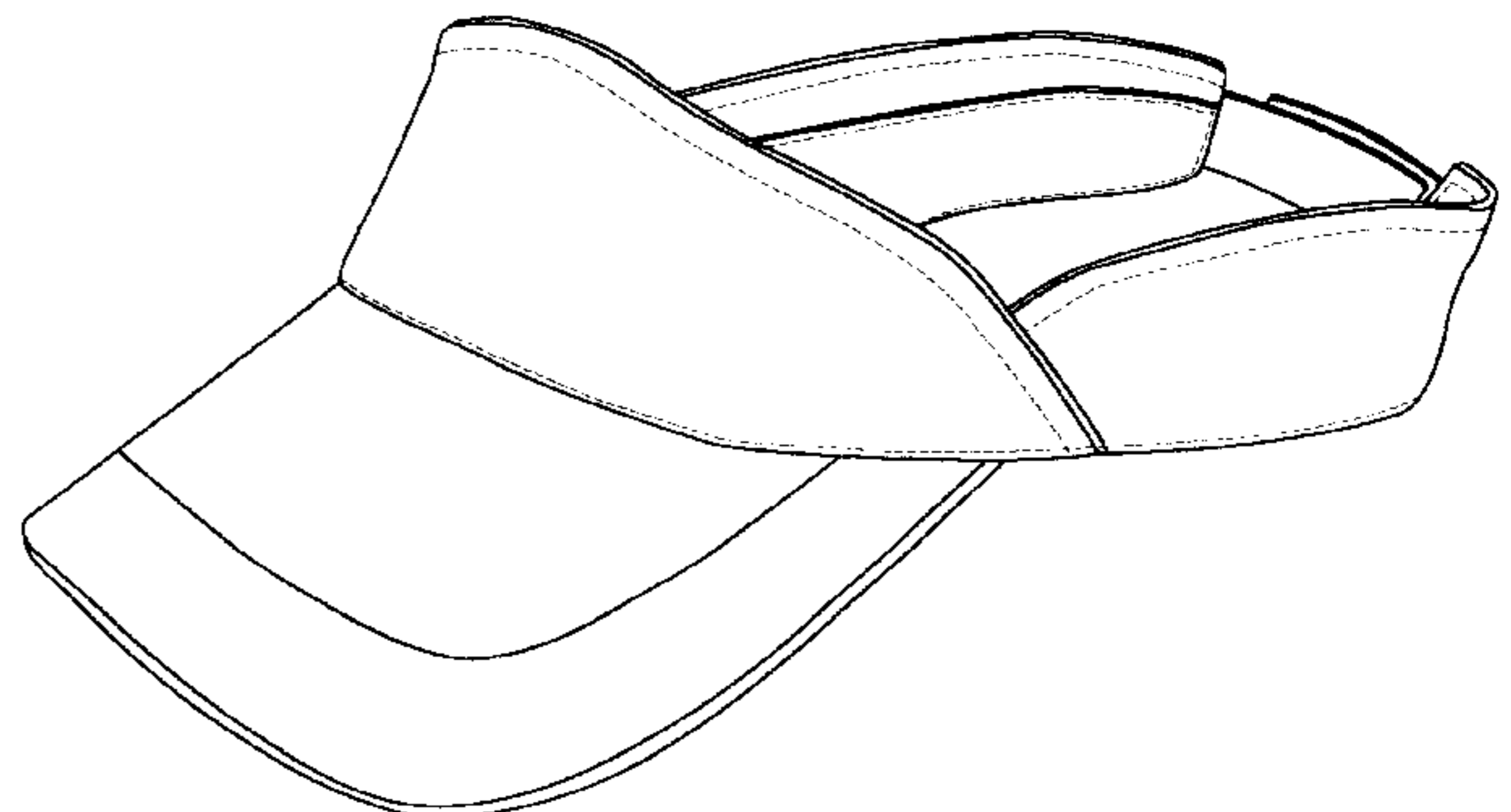
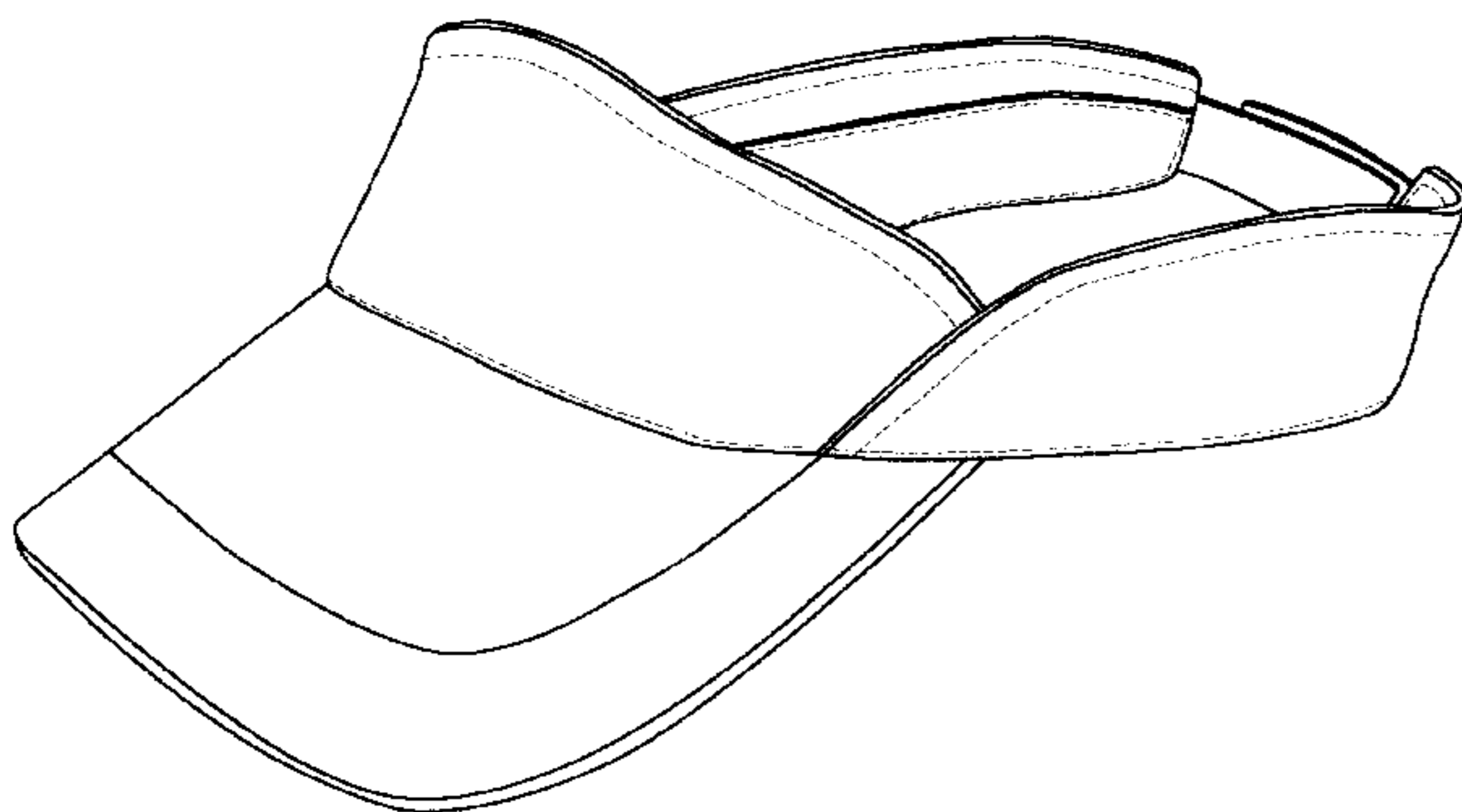

FIG.1

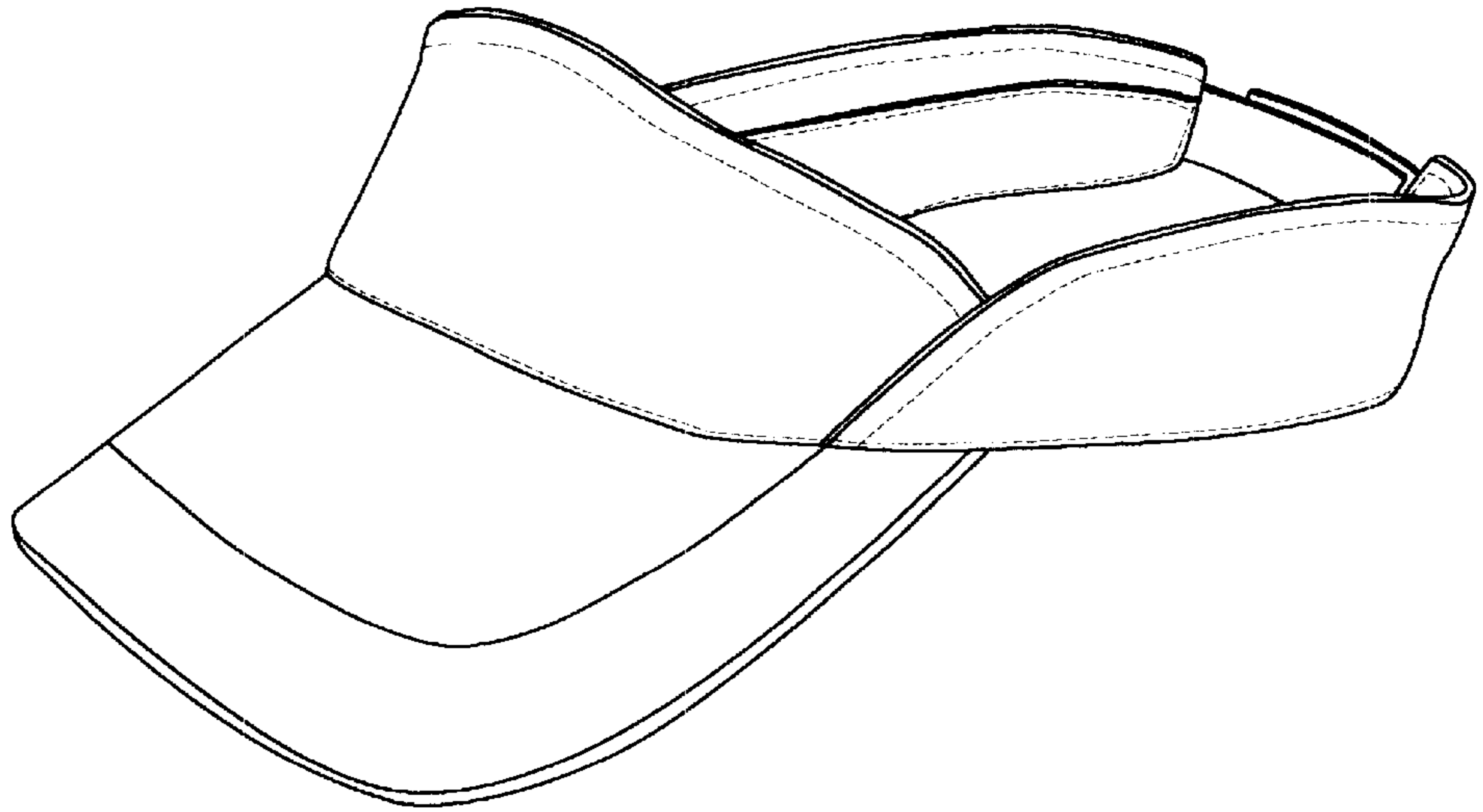

FIG.2

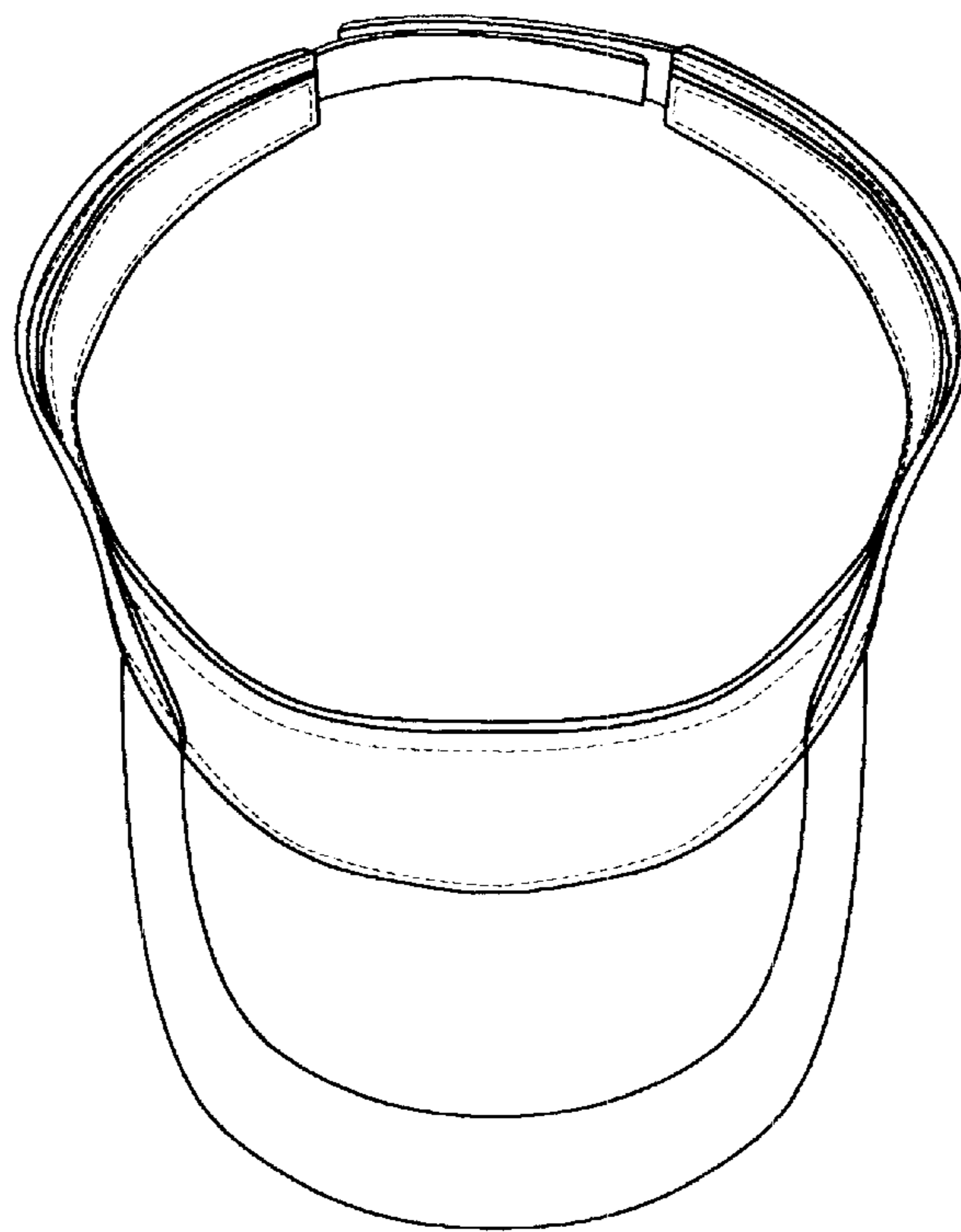

FIG.3

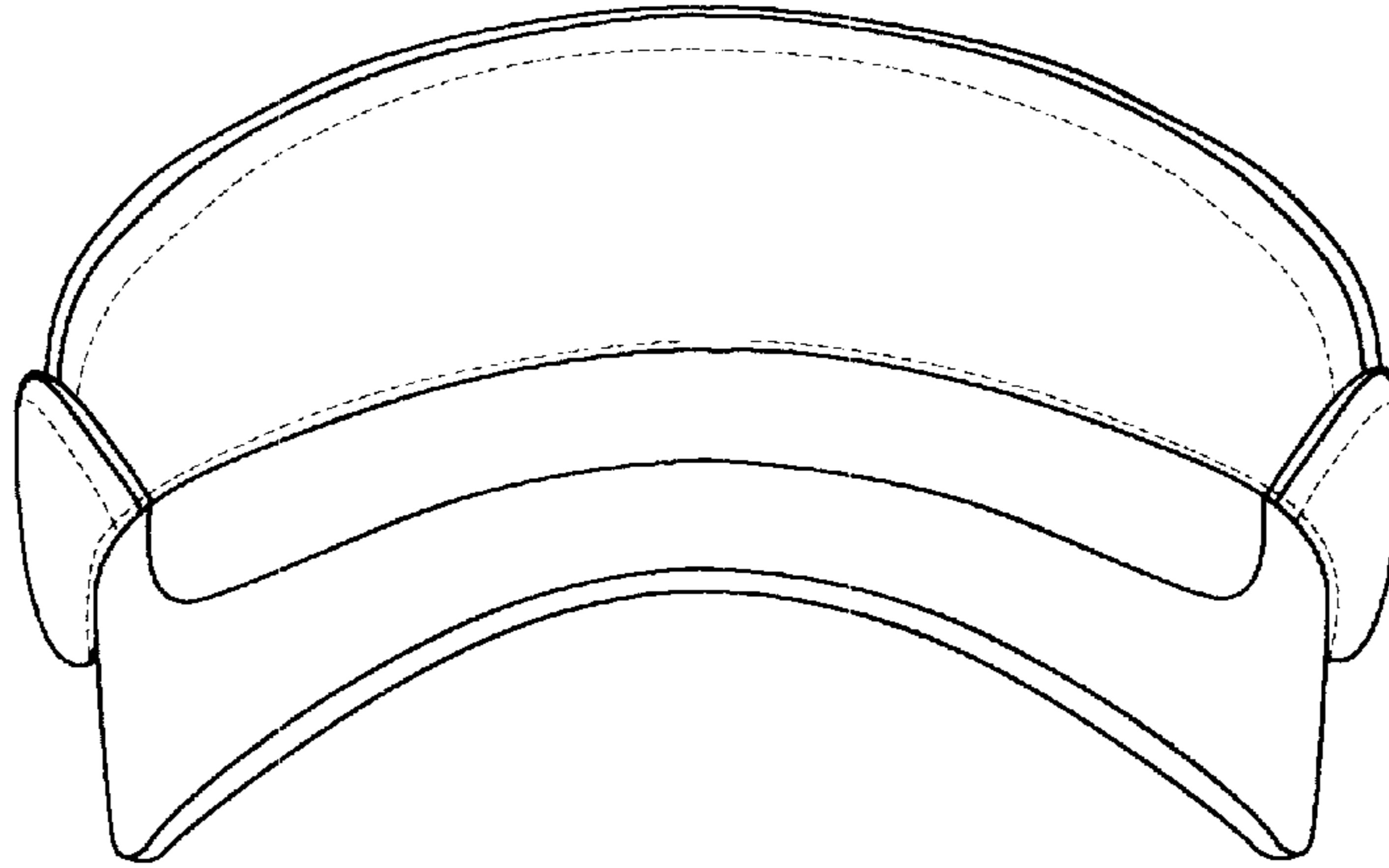

FIG.4

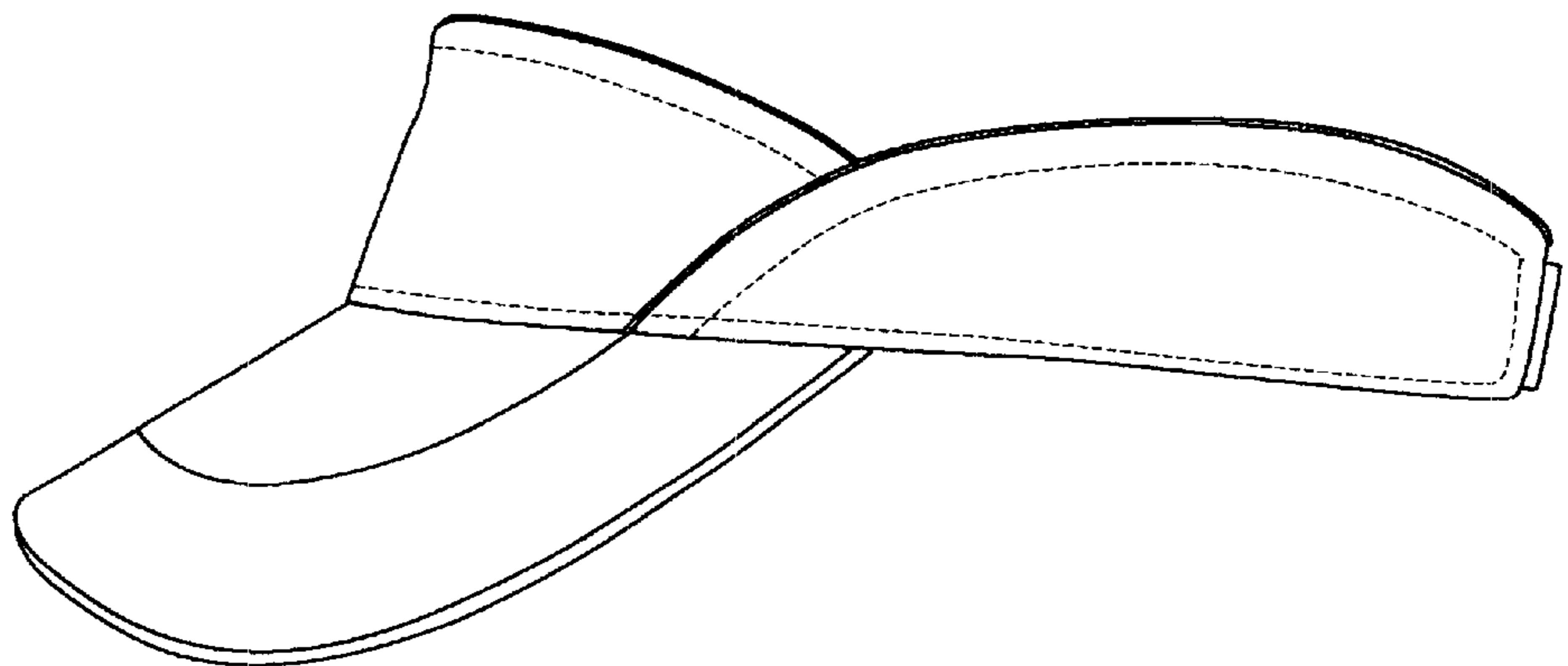

FIG.5

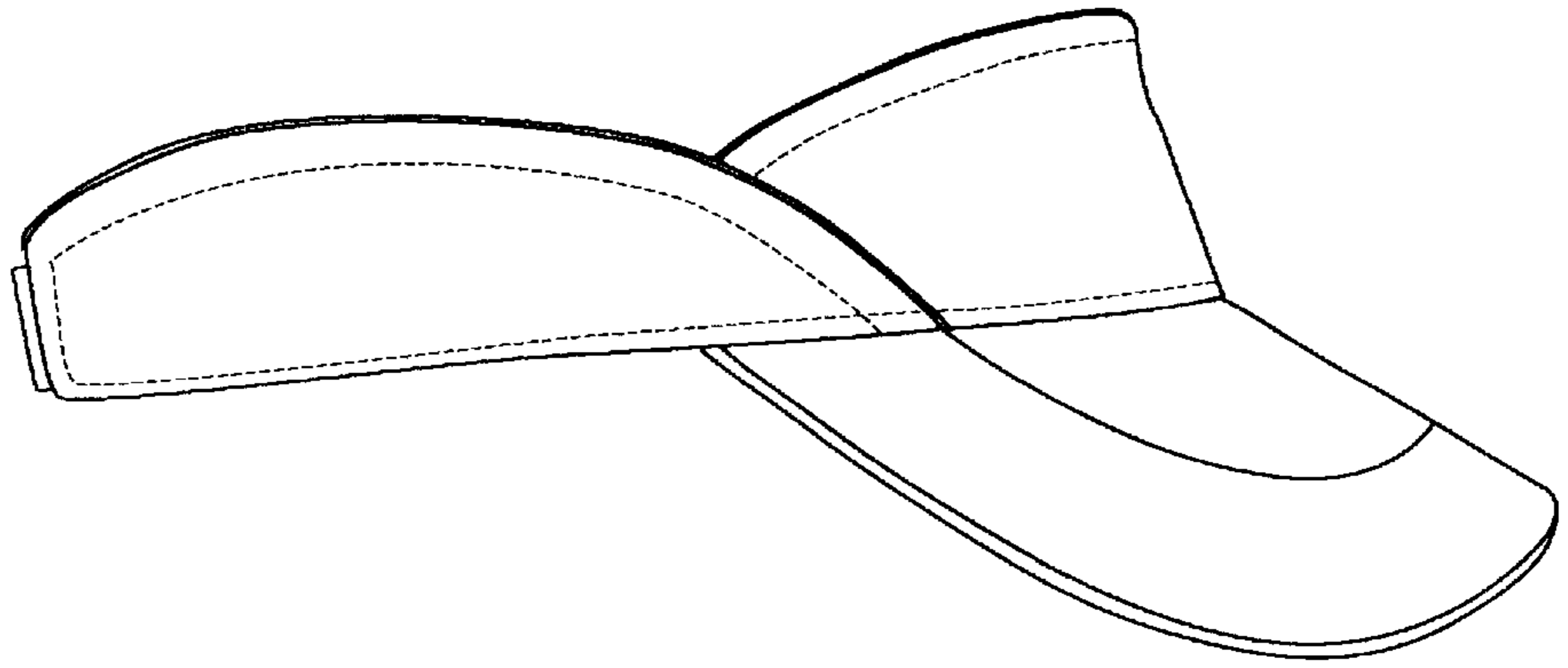

FIG.6

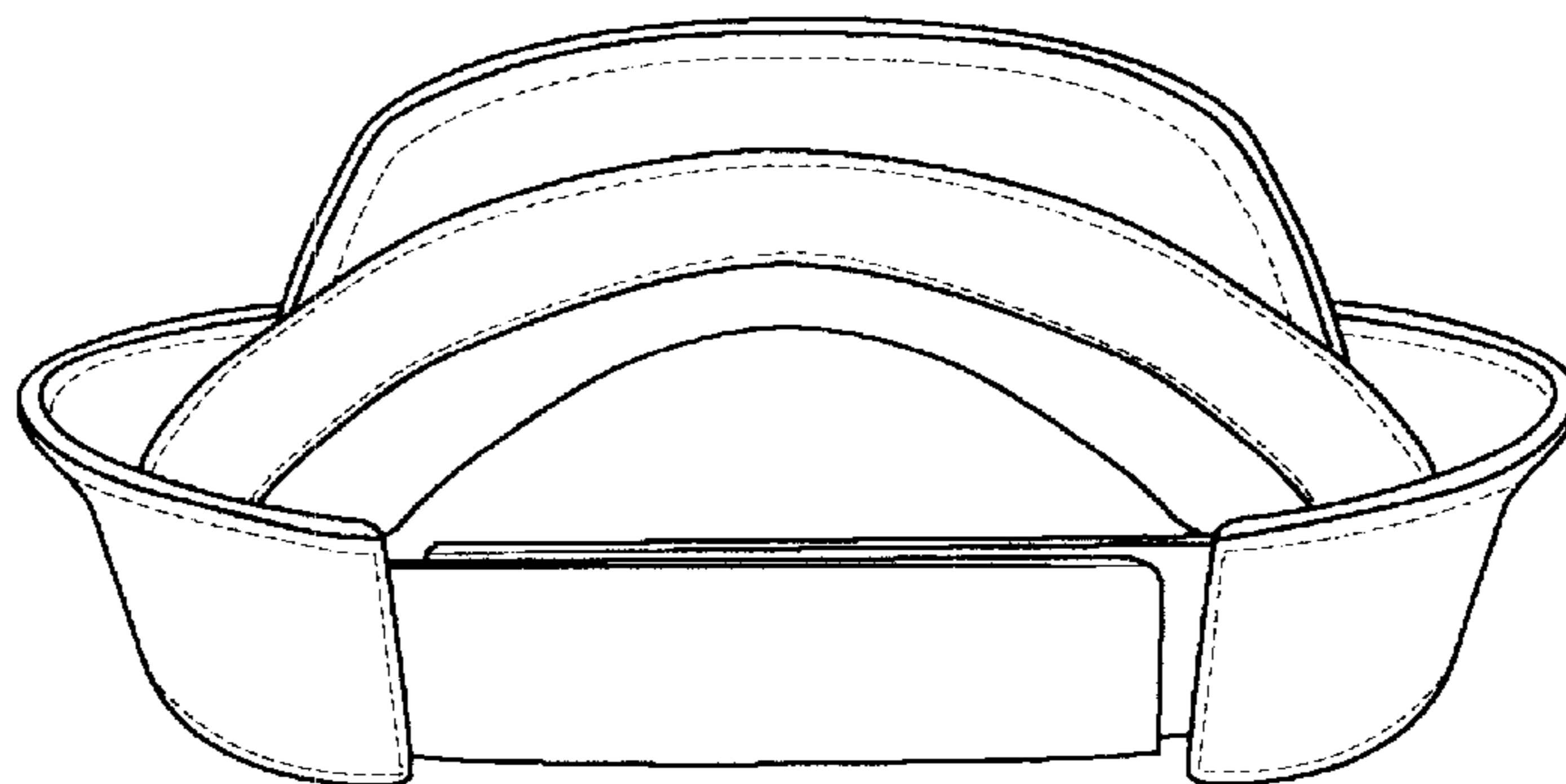

FIG.7

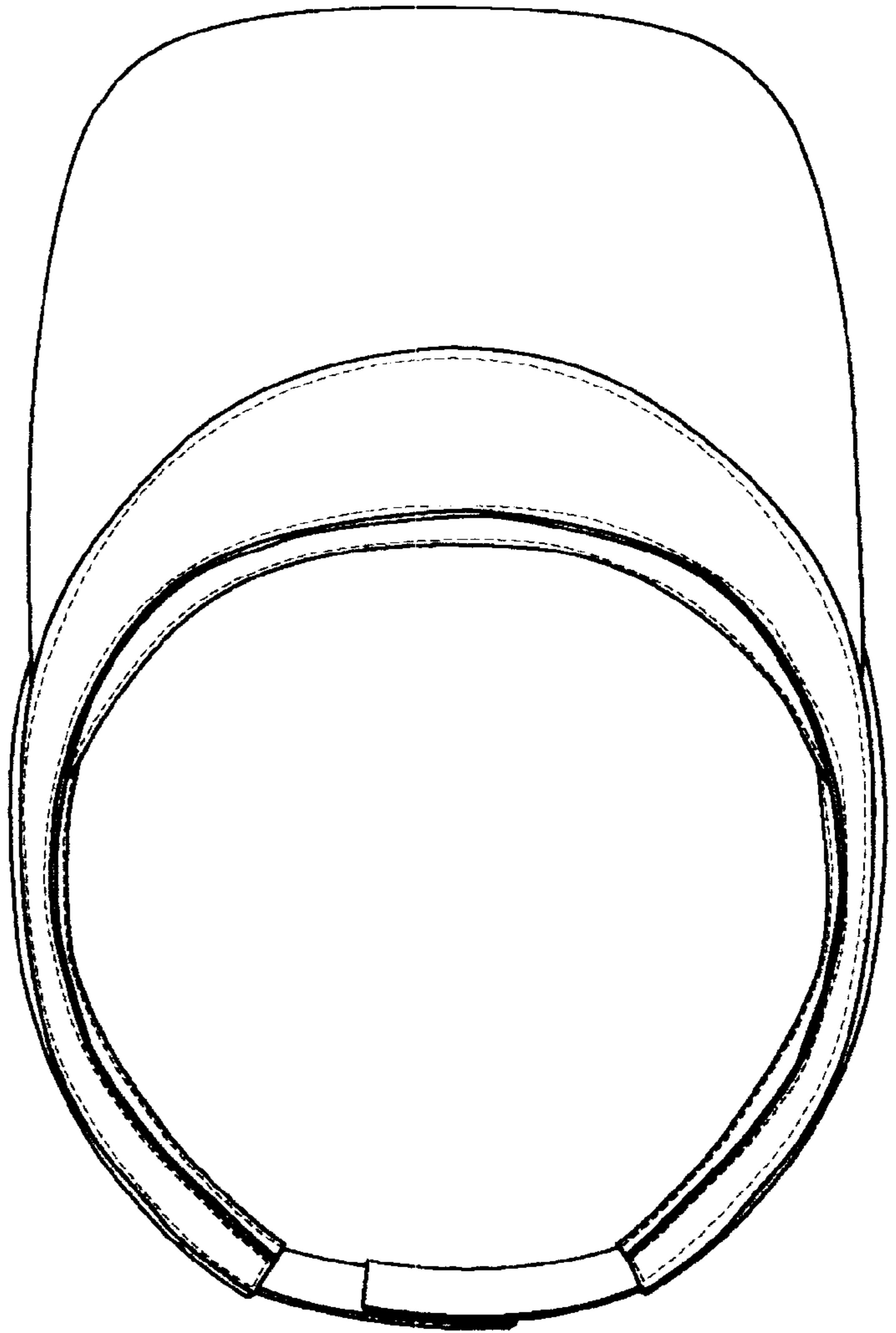

FIG.8

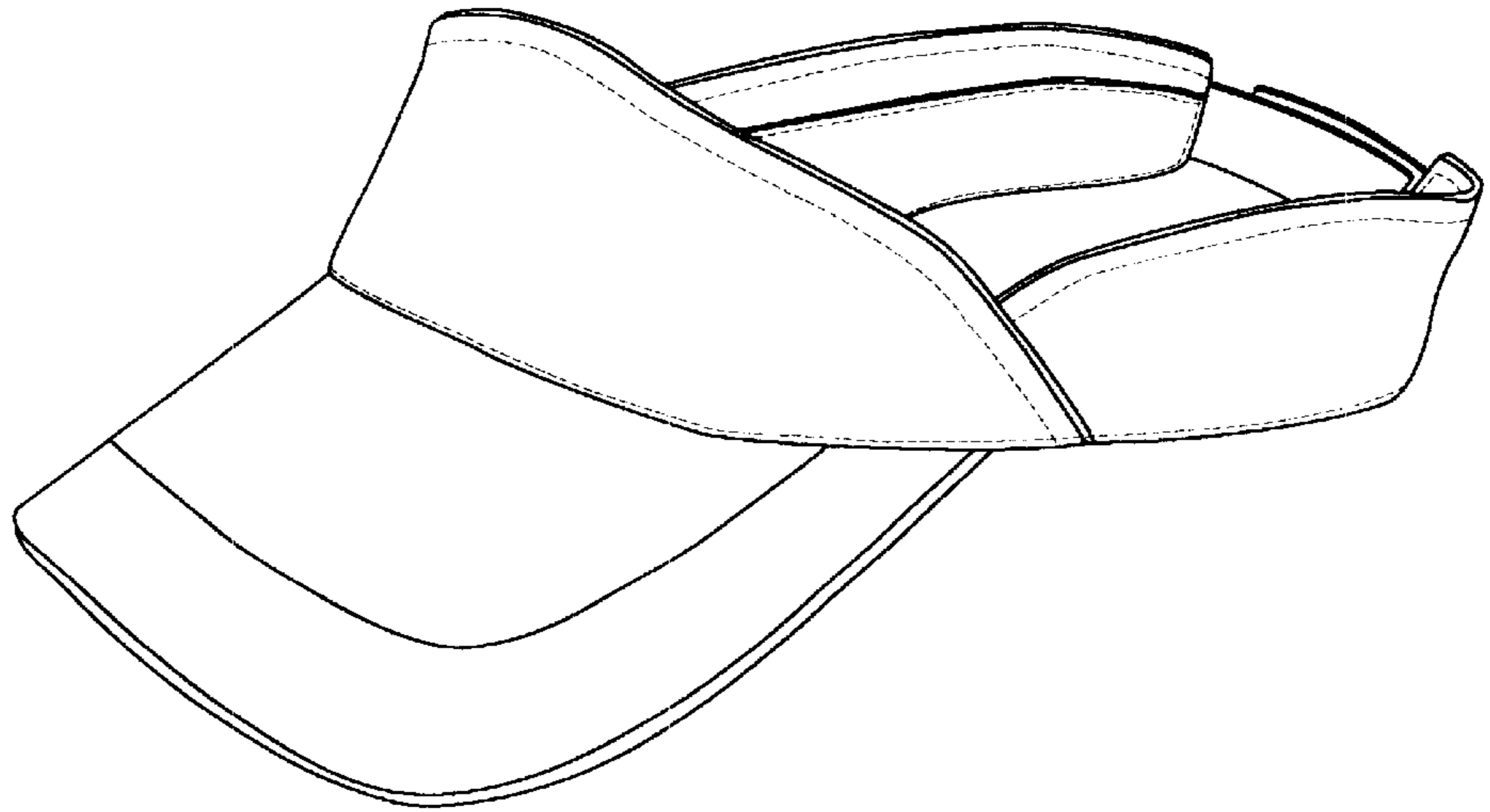

FIG.9

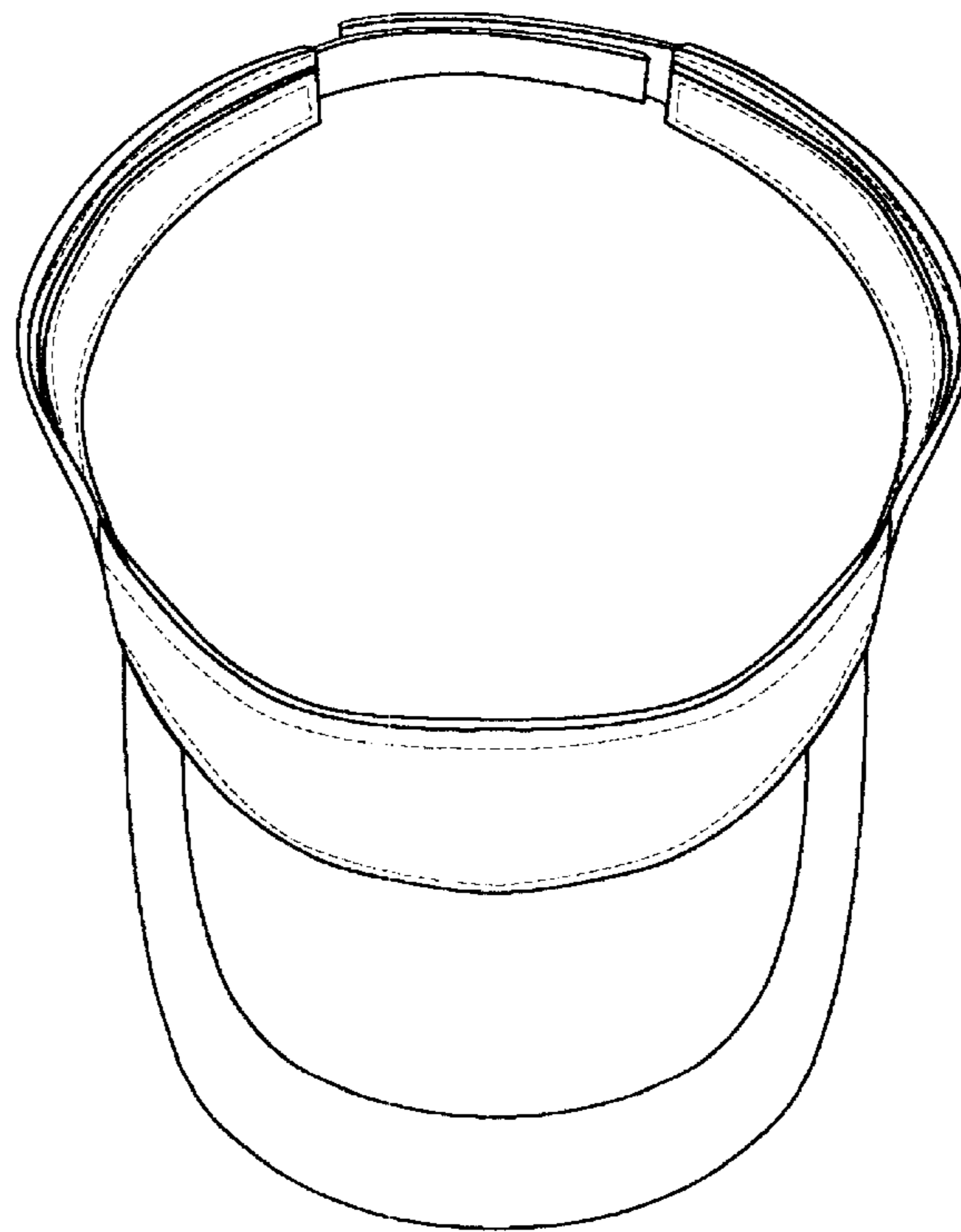

FIG.10

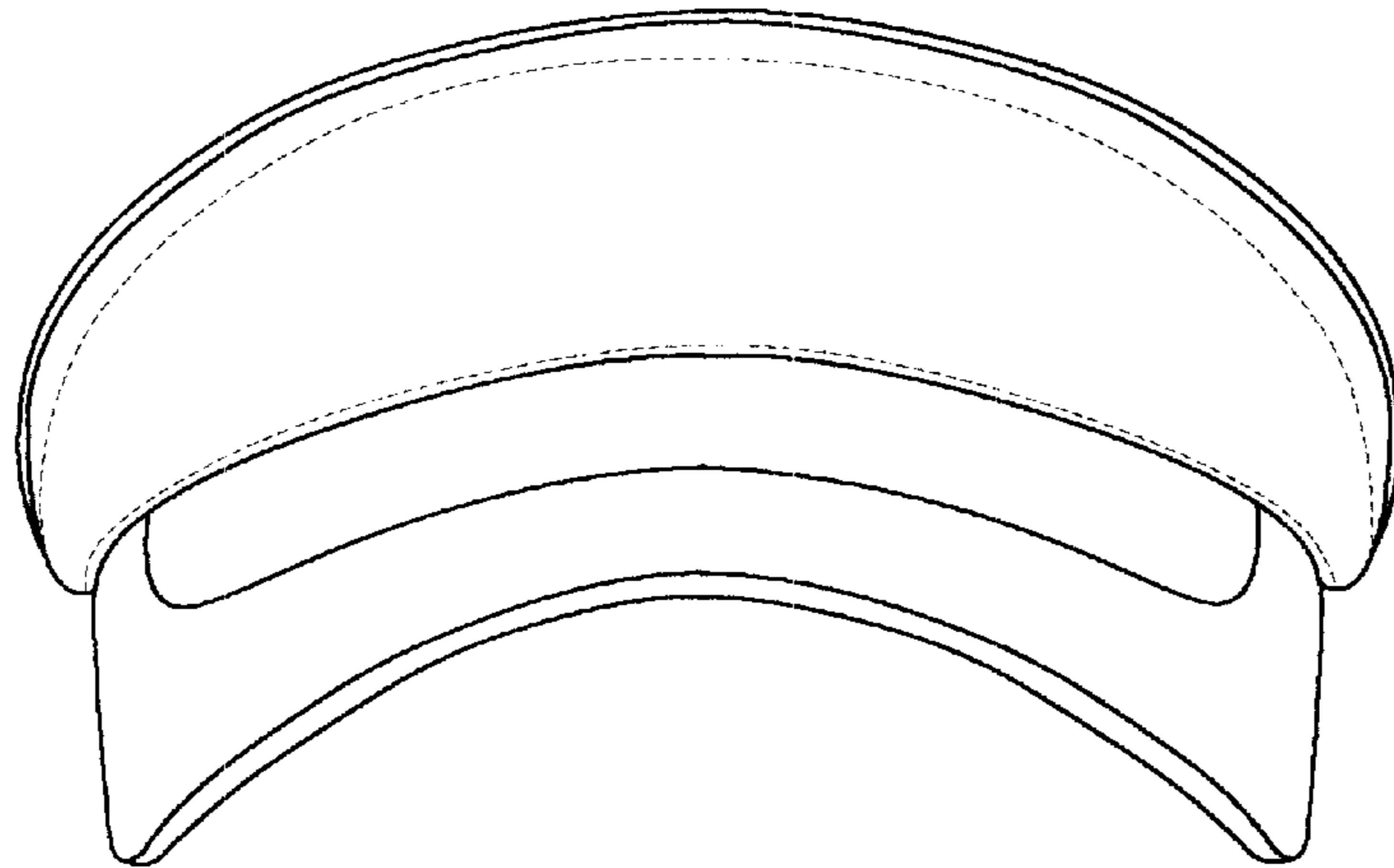

FIG.11

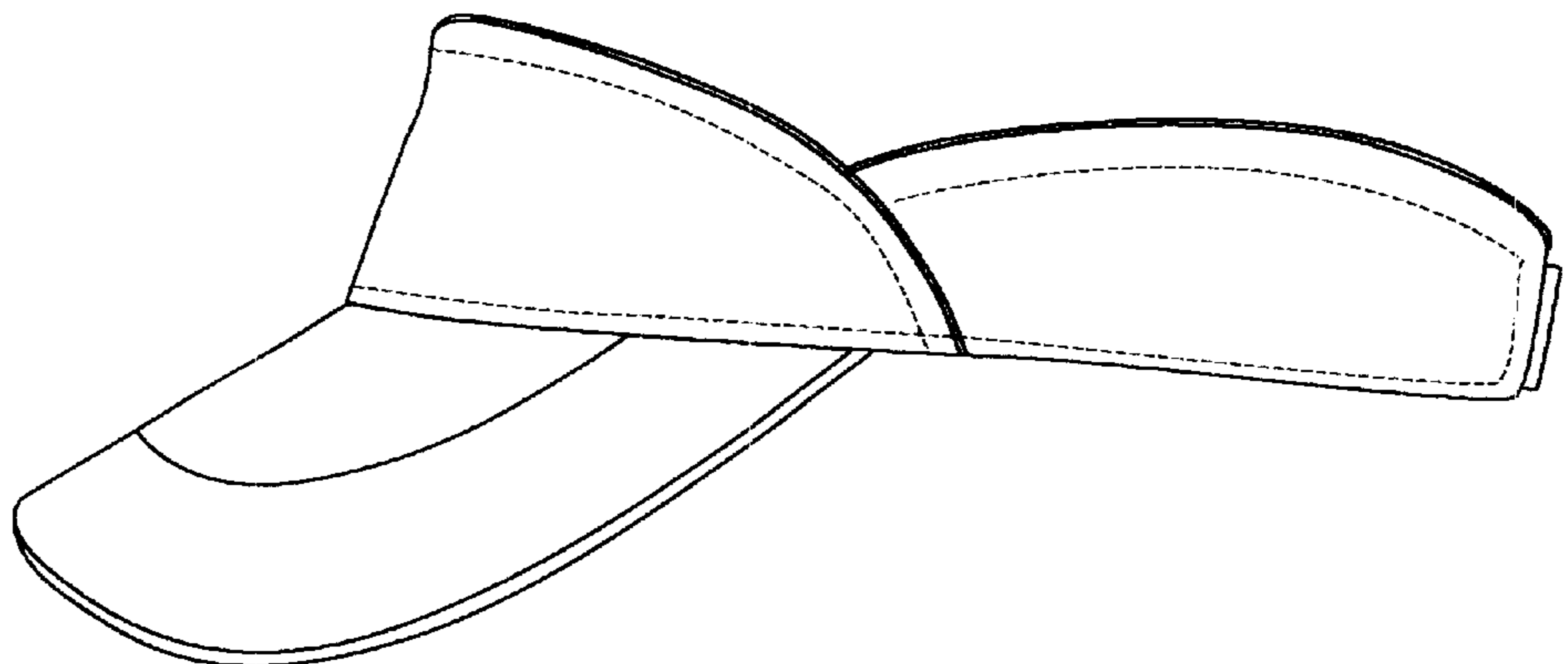

FIG.12

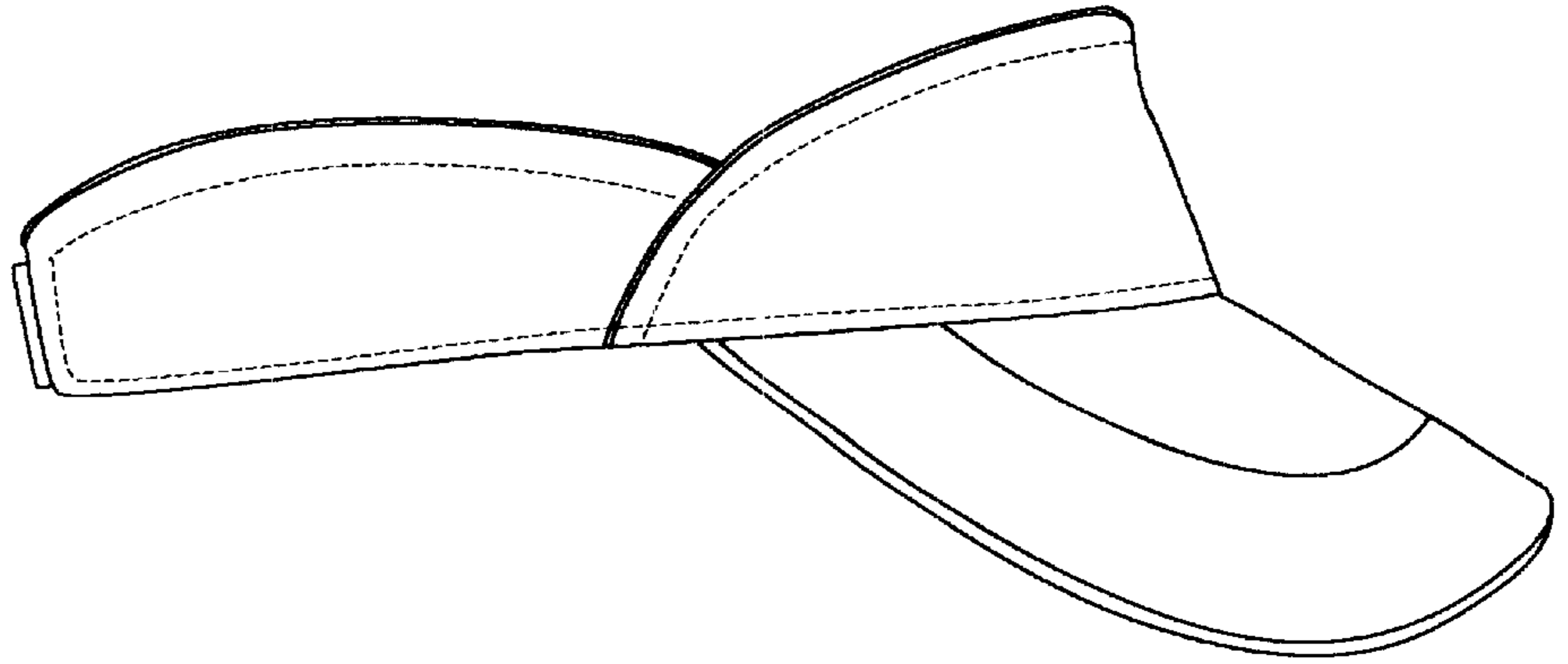

FIG.13

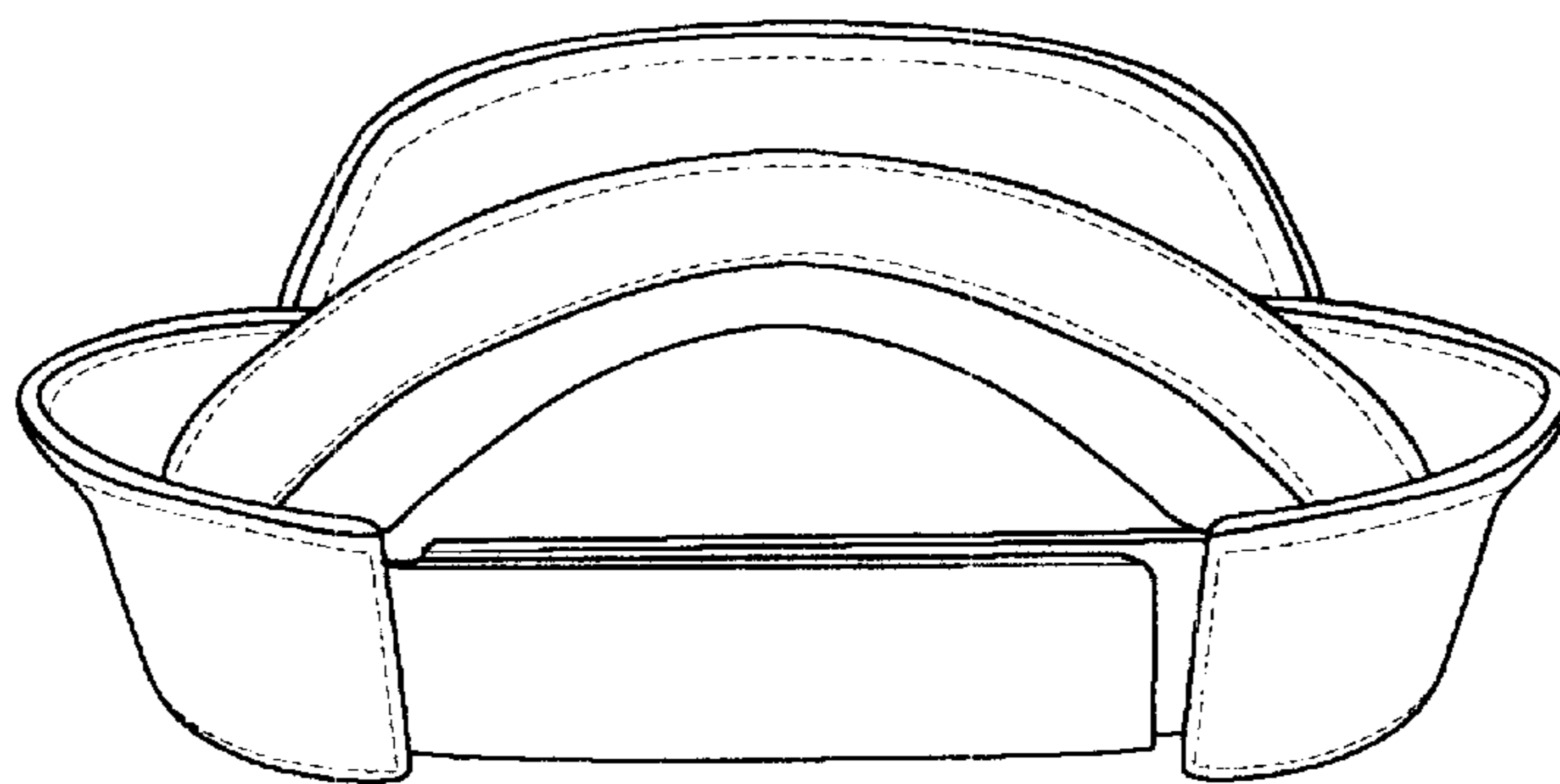

FIG.14

