

US00D460229S

(12) **United States Design Patent**  
**Zahuranec et al.**

(10) **Patent No.:** **US D460,229 S**

(45) **Date of Patent:** **\*\* Jul. 9, 2002**

(54) **CLEAN WATER TANK FOR A CARPET EXTRACTOR**

(75) Inventors: **Terry L. Zahuranec**, North Olmsted; **Brett Latimer**; **Robert A. Salo**, both of Mentor; **Mark E. Cipolla**, Chardon; **Wallace D. Tiller, Jr.**, Stow; **Jeffrey M. Kalman**, Cleveland Heights; **Craig M. Saunders**, Rocky River; **Richard C. Farone**, Willoughby; **Robert A. Matousek**, Lakewood, all of OH (US)

(73) Assignee: **Royal Appliance Mfg. Co.**, Glenwillow, OH (US)

(\*\*) Term: **14 Years**

(21) Appl. No.: **29/135,551**

(22) Filed: **Jan. 12, 2001**

(51) **LOC (7) Cl.** ..... **15-05**

(52) **U.S. Cl.** ..... **D32/31; D32/22**

(58) **Field of Search** ..... D32/22, 25, 30-31, D32/34; 15/320-323, 347, 350, 352-353, DIG. 8, DIG. 10; 55/337, 429, 266, 310-311, 345, 420; 95/12, 19, 271

(56) **References Cited**

**U.S. PATENT DOCUMENTS**

- D190,626 S \* 6/1961 Musichuk ..... D32/31
- D358,241 S 5/1995 Bradd
- D365,179 S 12/1995 Bradd
- 5,524,321 A 6/1996 Weaver et al.
- D374,955 S \* 10/1996 Umbach ..... D32/21
- 5,615,448 A 4/1997 Crouser et al.
- D387,518 S 12/1997 Medema

- 5,784,755 A 7/1998 Karr et al.
- D406,928 S 3/1999 Rowley et al.
- 5,896,617 A 4/1999 Kasen et al.
- D421,164 S \* 2/2000 Luebbering ..... D32/22
- D433,201 S \* 10/2000 Wright et al. .... D32/30
- 6,154,917 A \* 12/2000 Zahuranec et al. .... 15/320
- D439,381 S \* 3/2001 Saunders et al. .... D32/31
- D442,344 S \* 5/2001 Alford et al. .... D32/31
- D444,275 S \* 6/2001 Mehaffey ..... D32/30

**OTHER PUBLICATIONS**

US 6,266,845, 07/2001, Lang (withdrawn)\*

\* cited by examiner

*Primary Examiner*—Ruth McInroy

(74) *Attorney, Agent, or Firm*—Fay, Sharpe, Fagan, Minnich & McKee, LLP

(57) **CLAIM**

The ornamental design for a clean water tank for a carpet extractor, as shown and described.

**DESCRIPTION**

FIG. 1 is a perspective view of a clean water tank for carpet extractor showing our new design; FIG. 2 is a perspective view of the clean water tank alone; FIG. 3 is a rear elevational view thereof; FIG. 4 is a left side elevational view thereof; FIG. 5 is a front elevational view thereof; FIG. 6 is a right side elevational view thereof; FIG. 7 is a top plan view thereof; and, FIG. 8 is a bottom plan view thereof.

The carpet extractor parts shown in broken lines in FIG. 1 are shown for illustrative purposes only and form no part of the claimed design.

**1 Claim, 5 Drawing Sheets**

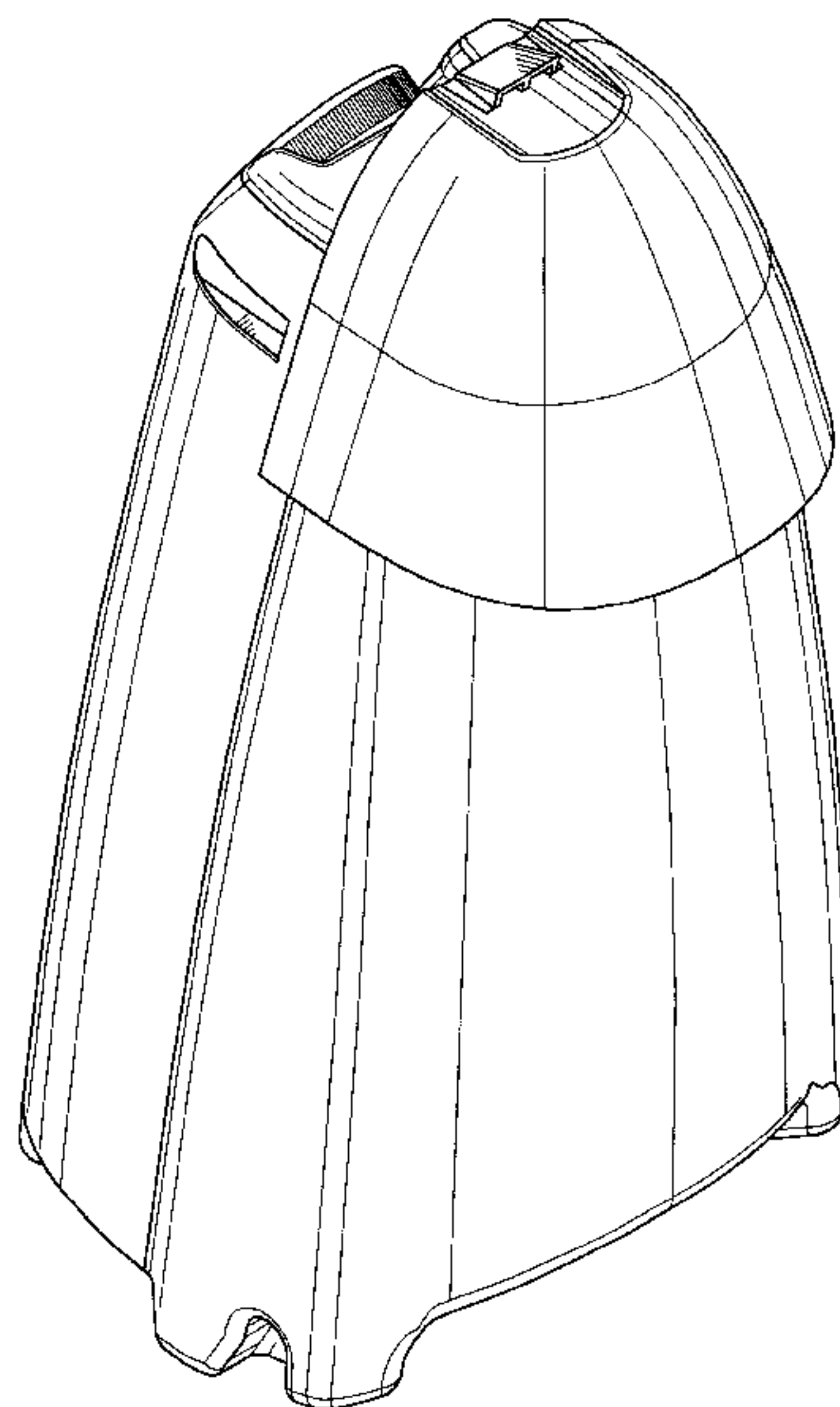
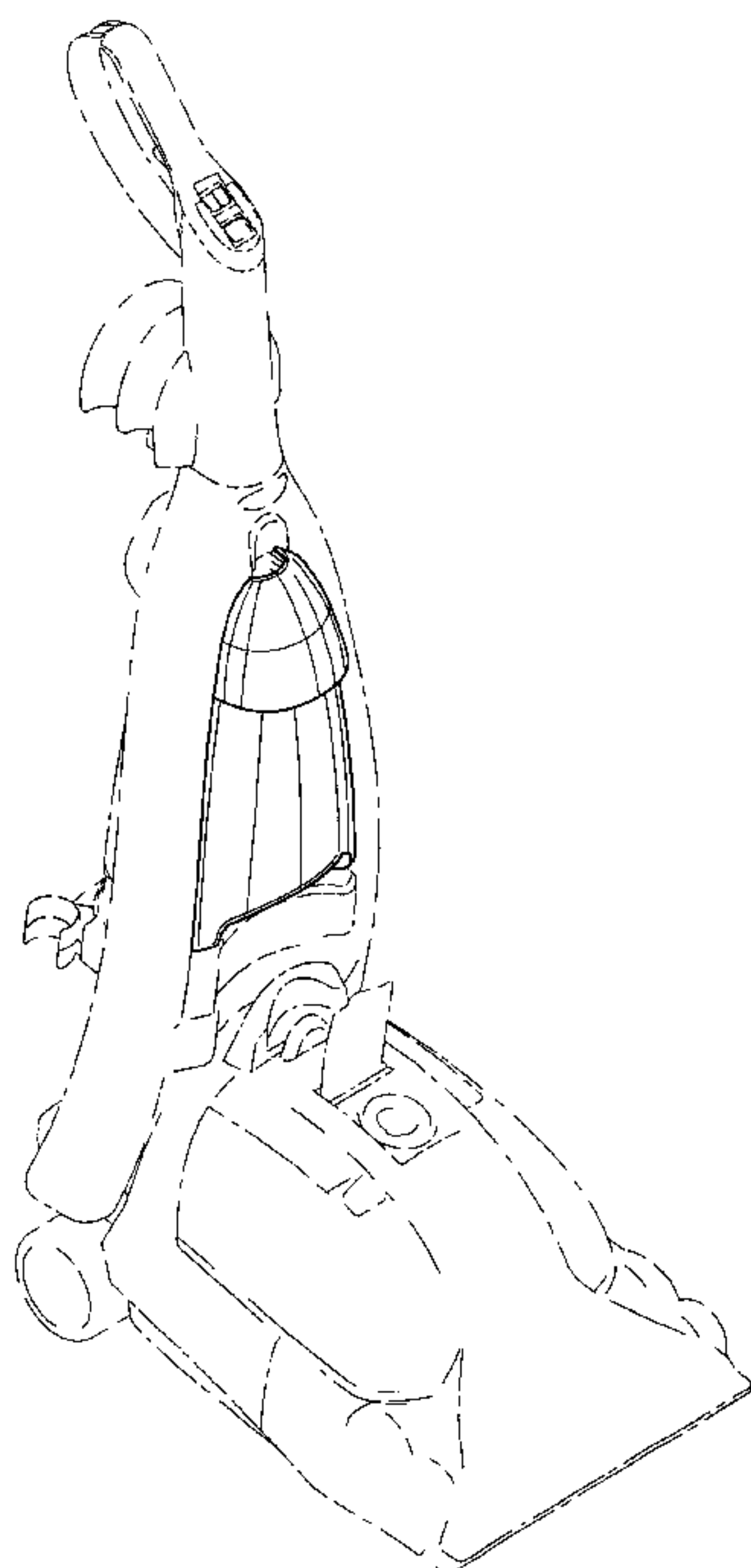

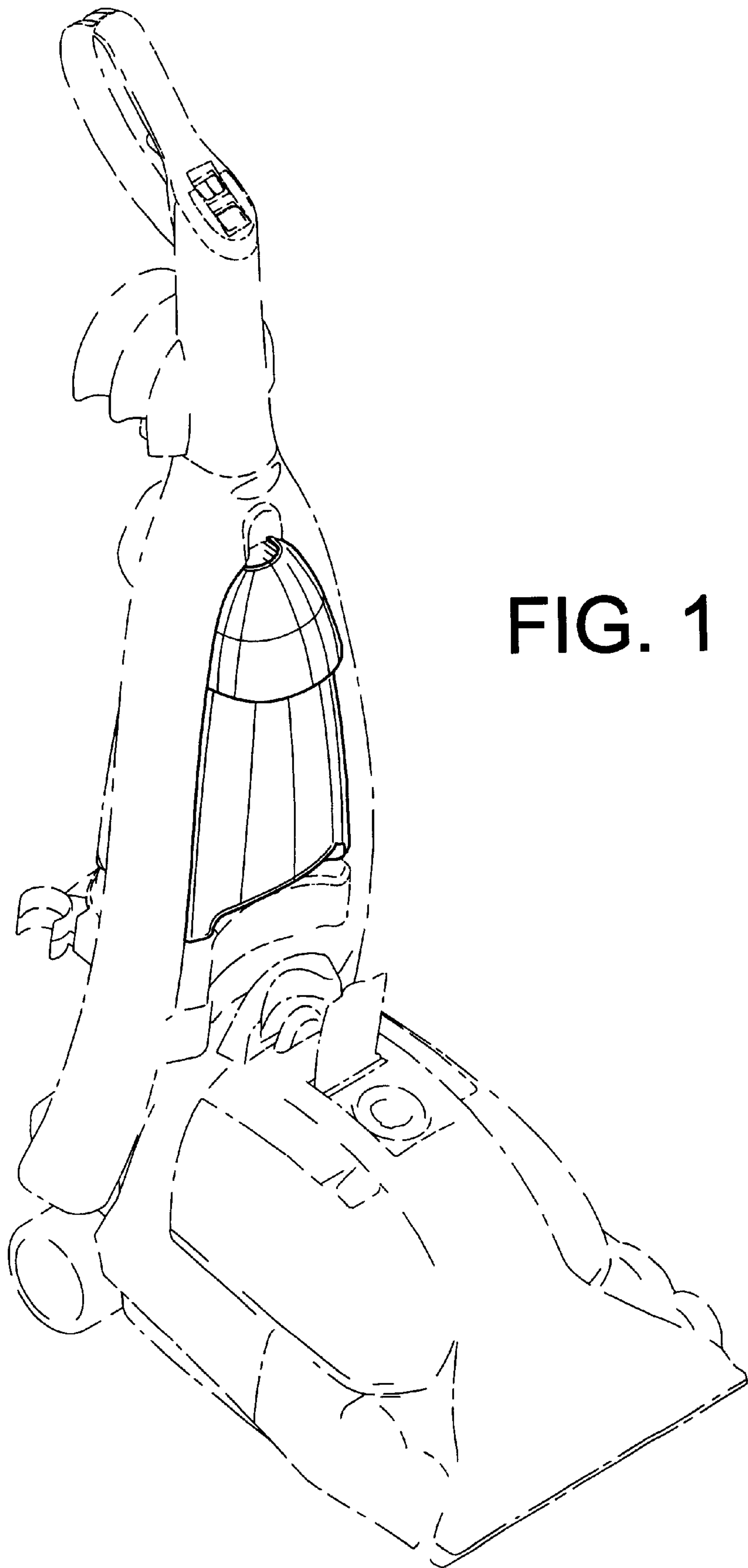

FIG. 1

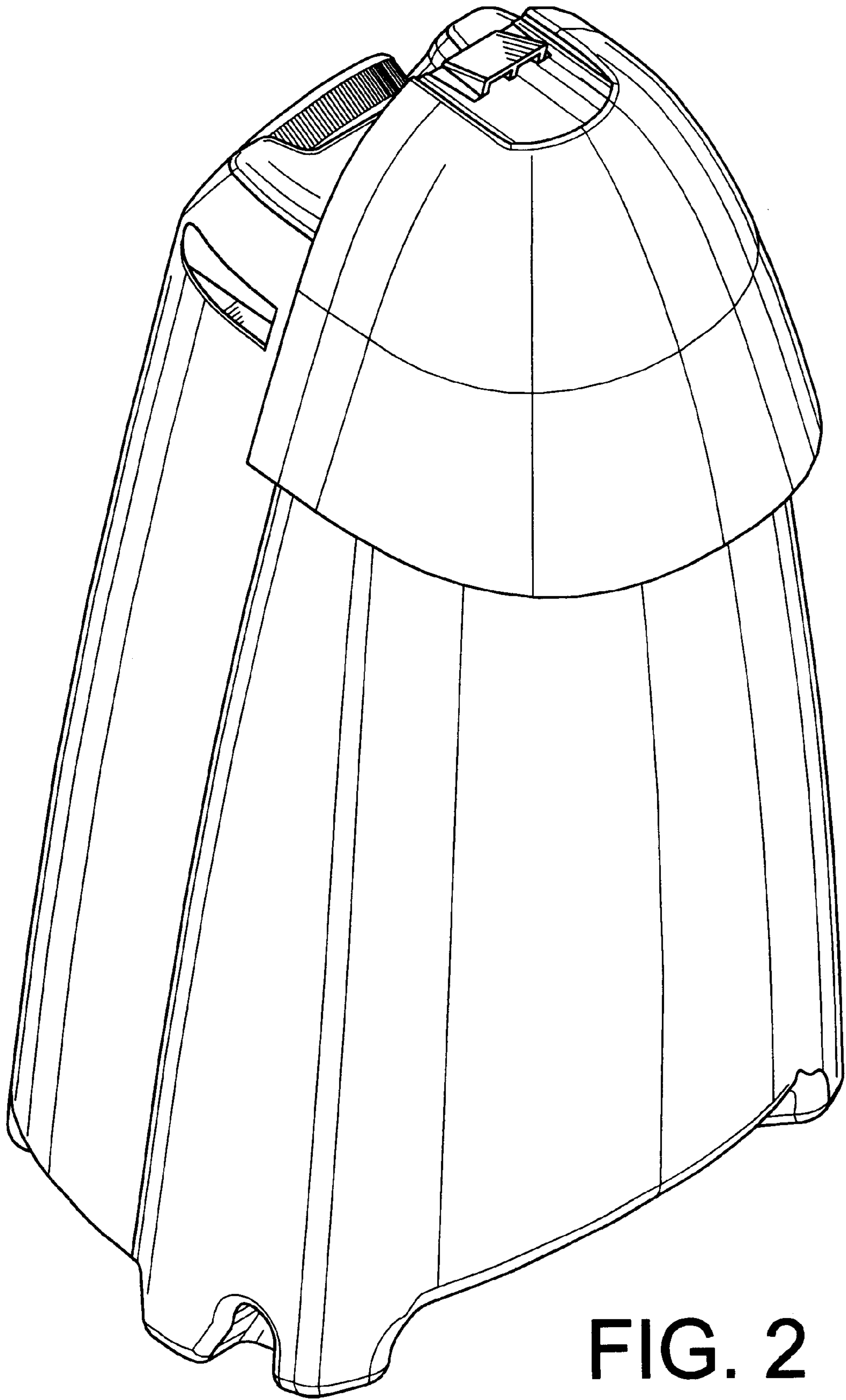

FIG. 2

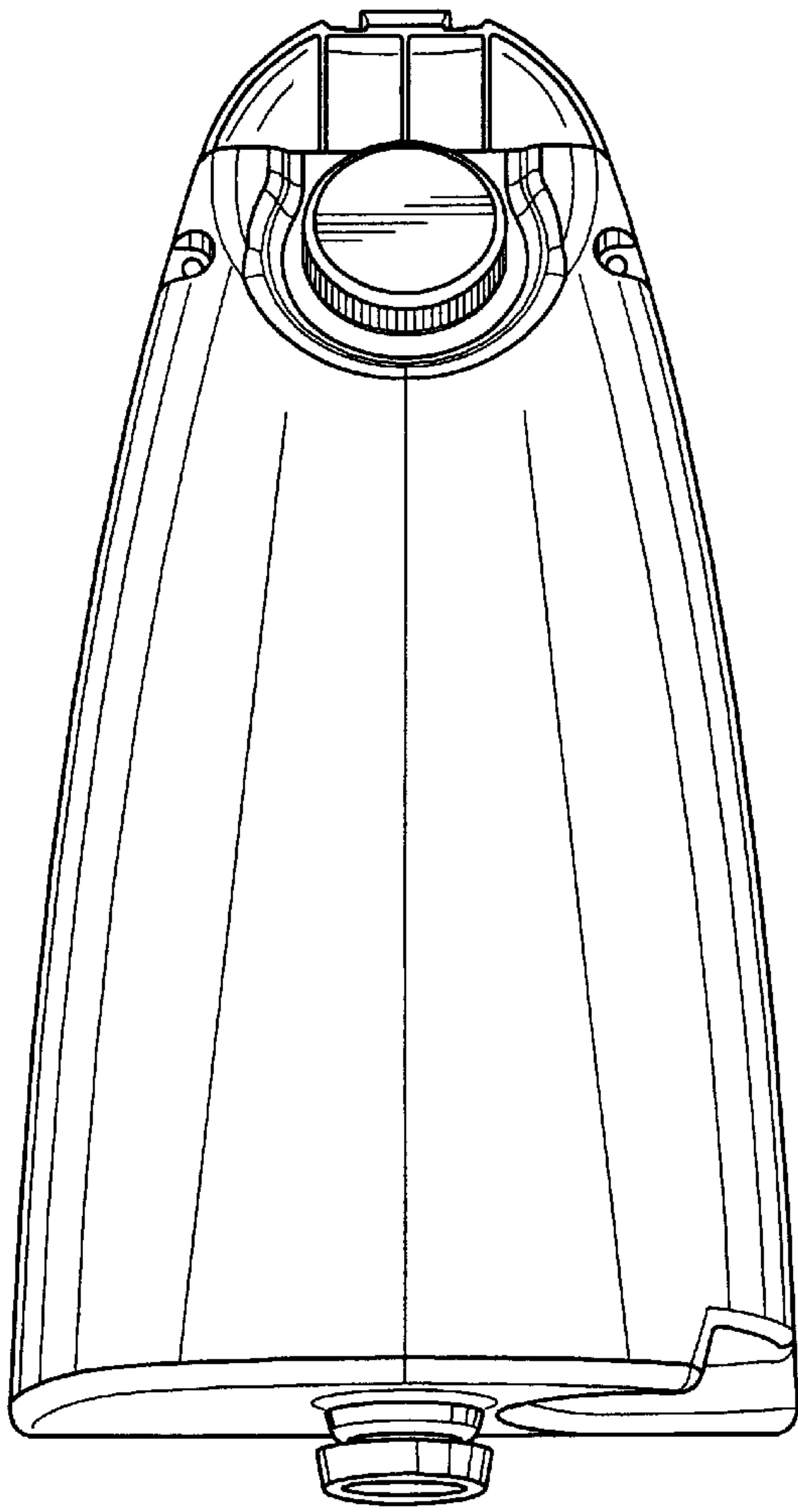

FIG. 3

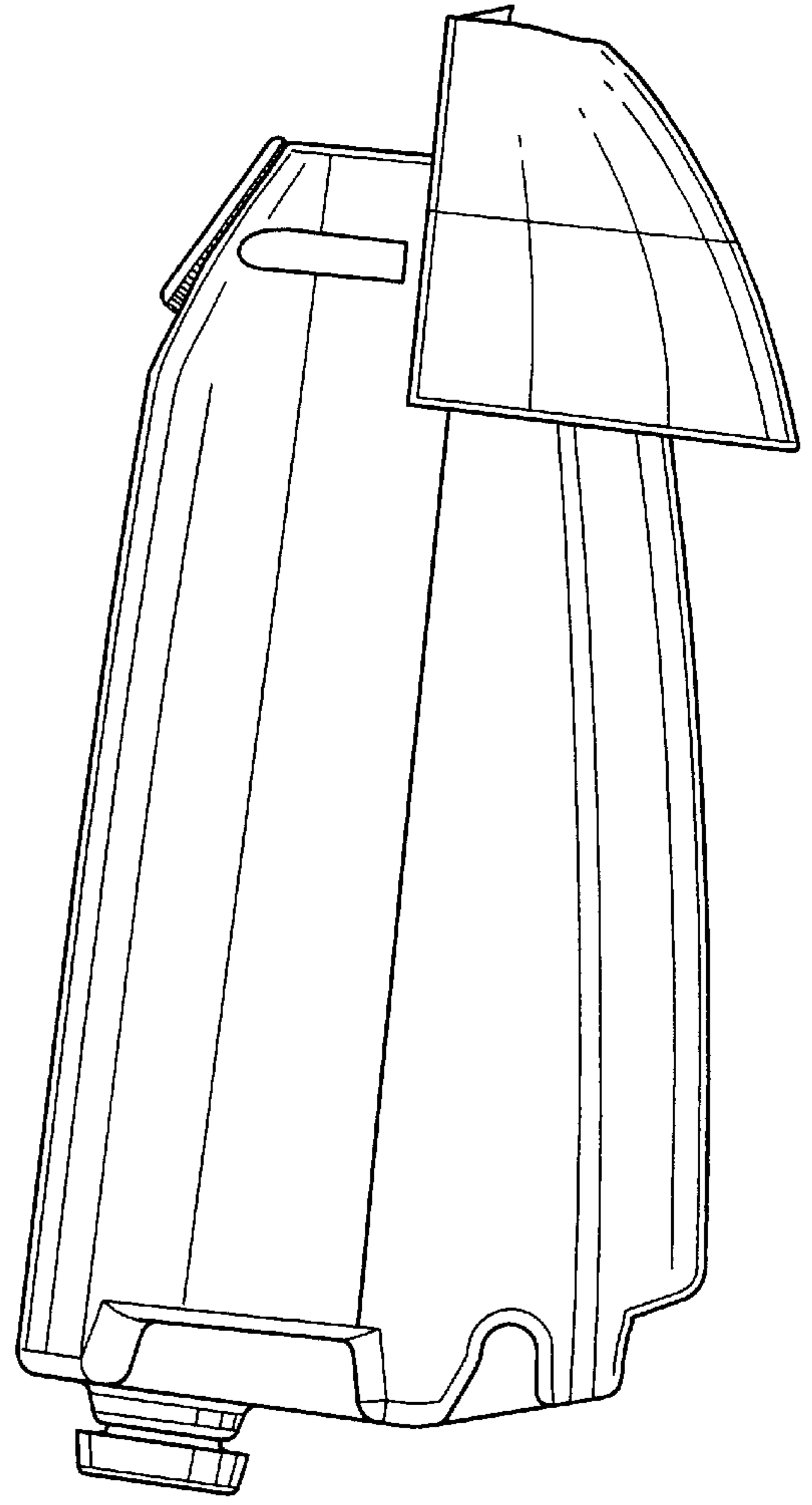

FIG. 4

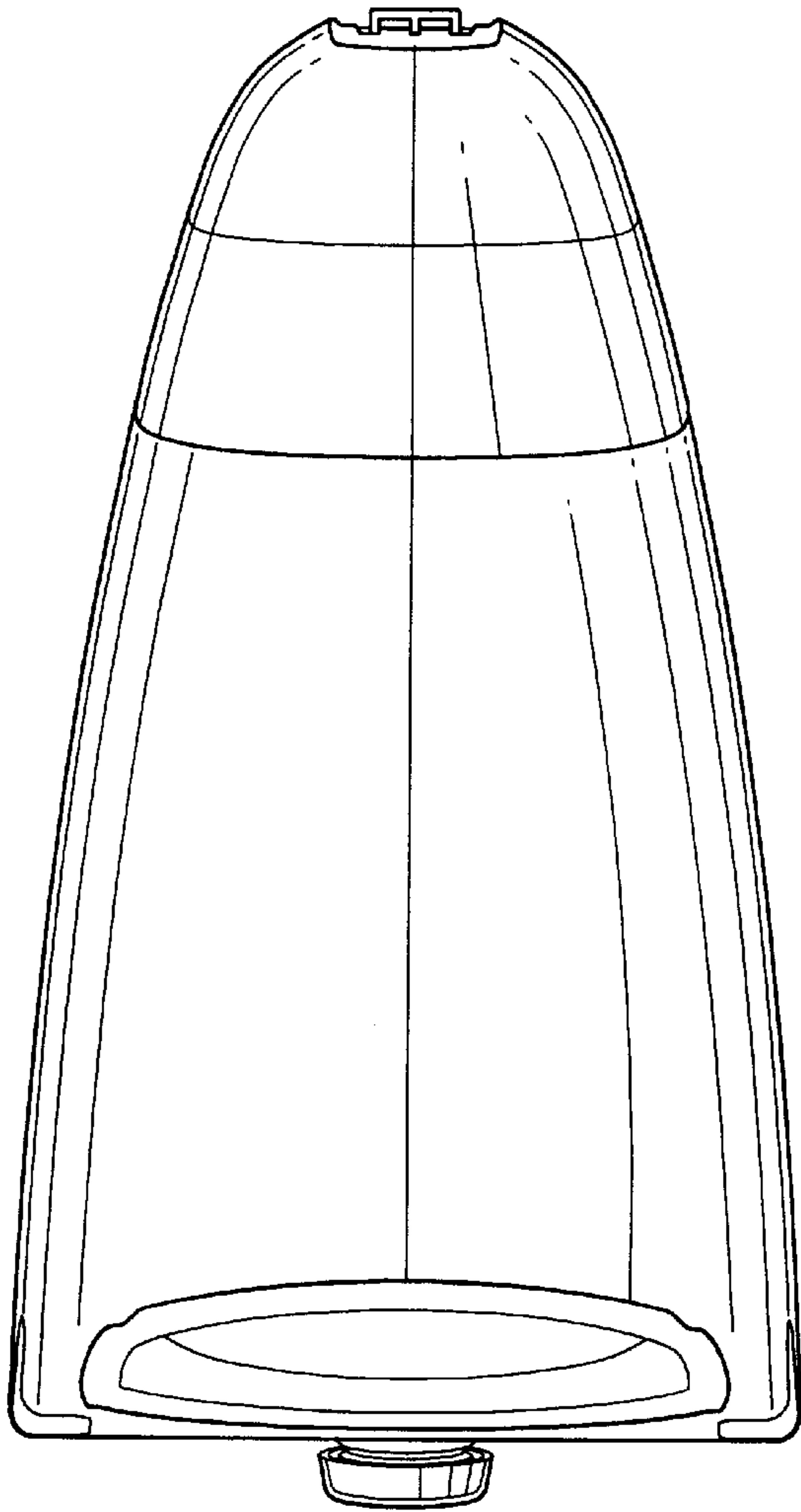

FIG. 5

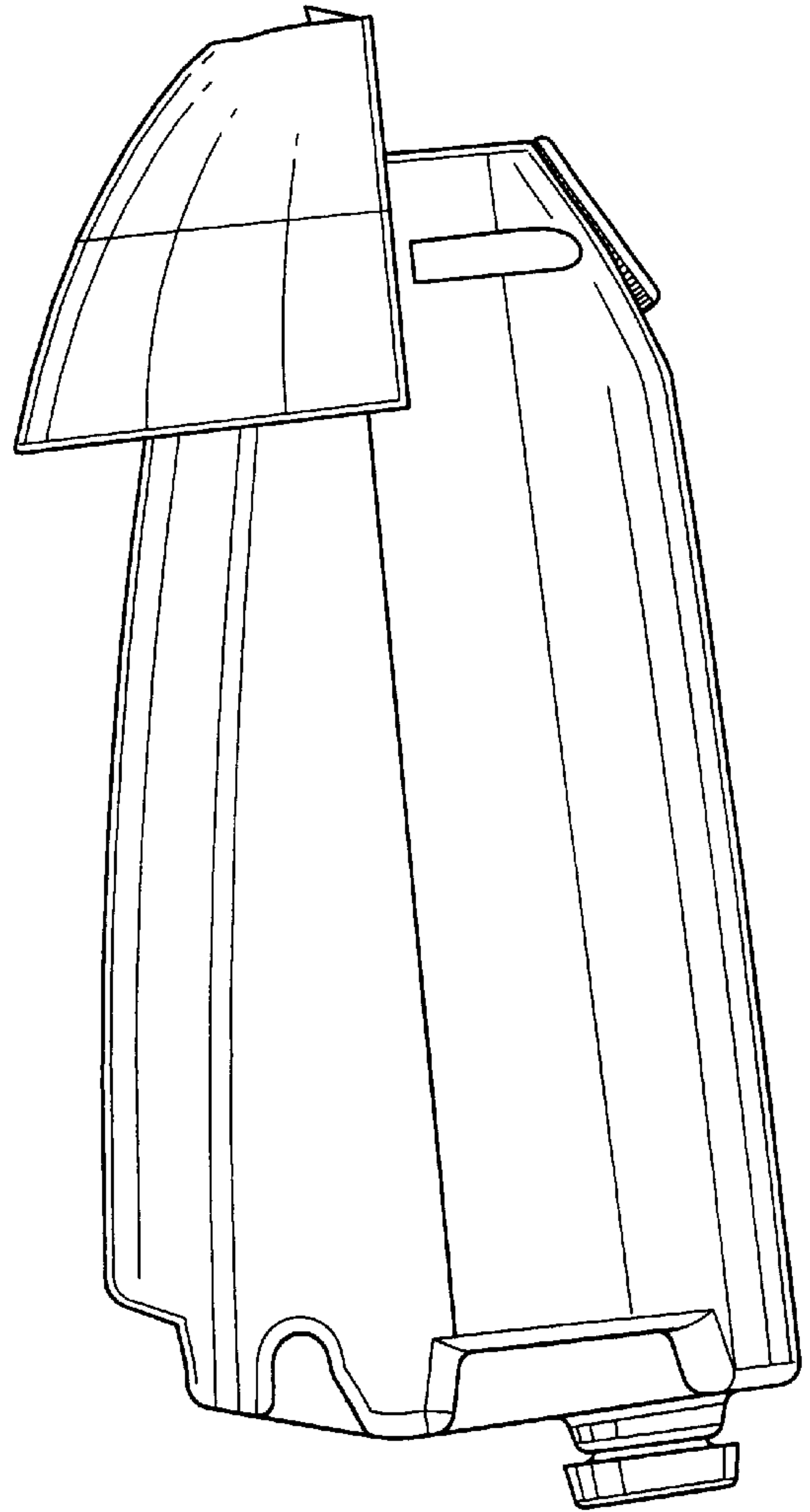

FIG. 6



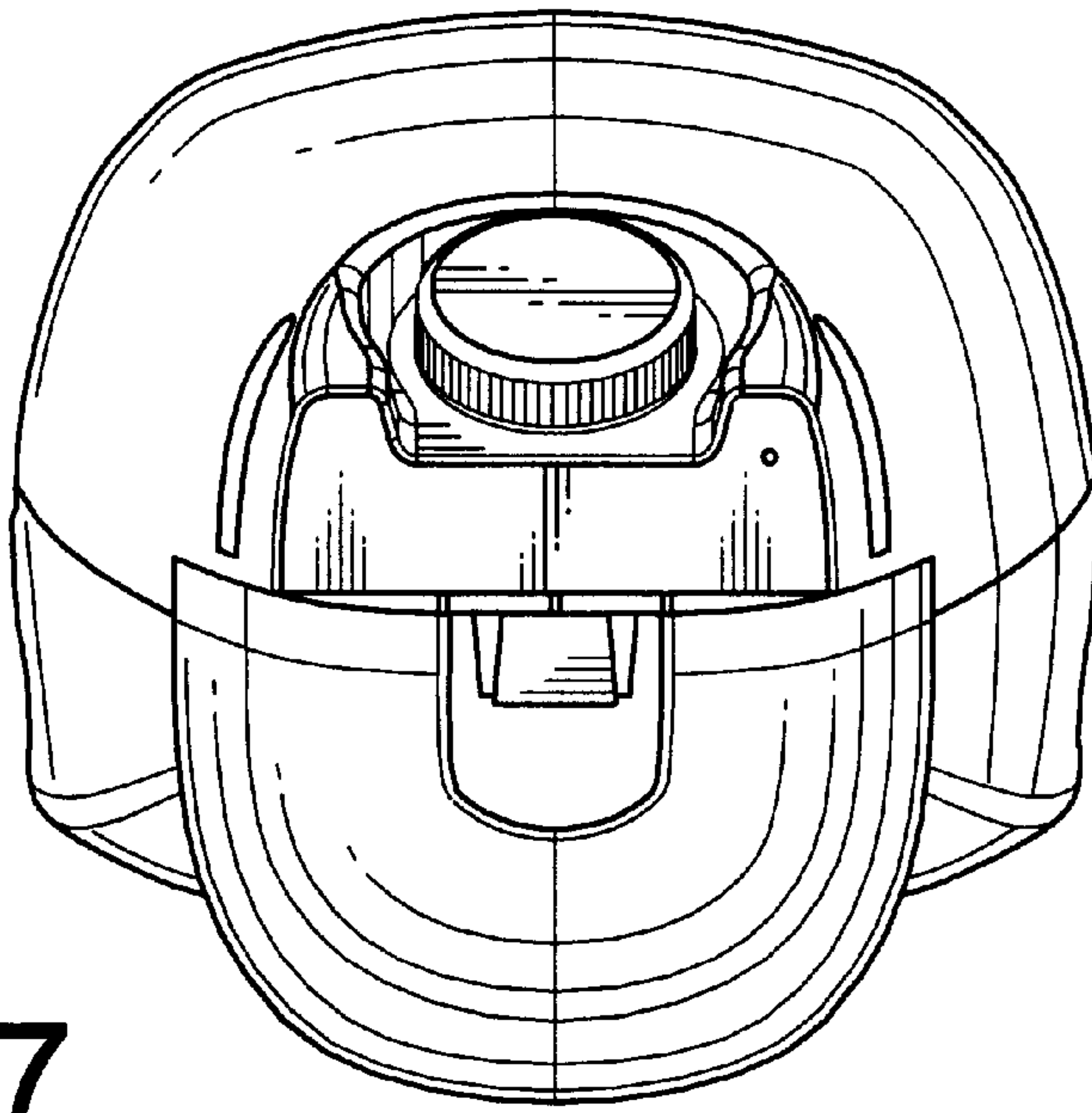

FIG. 7

FIG. 8

