



US00D460181S

(12) **United States Design Patent**
Swenson

(10) **Patent No.:** **US D460,181 S**

(45) **Date of Patent:** **** Jul. 9, 2002**

(54) **TRANSFER DEVICE**

(75) **Inventor:** **Kirk D. Swenson, Wayne, NJ (US)**

(73) **Assignee:** **Becton, Dickinson and Company,**
Franklin Lakes, NJ (US)

(**) **Term:** **14 Years**

(21) **Appl. No.:** **29/146,237**

(22) **Filed:** **Aug. 7, 2001**

(51) **LOC (7) Cl. 24-02**

(52) **U.S. Cl. D24/130; D24/108; D24/129**

(58) **Field of Search D24/130, 129,**
D24/112, 114, 167, 109, 108; 604/411,
263, 533, 535, 539, 6.15, 7, 8, 198; 600/576,
578, 573

(56) **References Cited**

U.S. PATENT DOCUMENTS

4,788,986 A * 12/1988 Harris 600/576

D307,796 S * 5/1990 Hanifl et al. D24/130

5,069,225 A * 12/1991 Okamura 600/578

D408,079 S * 4/1999 Ellis D24/108

6,224,576 B1 * 5/2001 Thorne et al. 604/198

* cited by examiner

Primary Examiner—Ian Simmons

(74) *Attorney, Agent, or Firm*—Nanette S. Thomas

(57) **CLAIM**

The ornamental design of a transfer device, as shown.

DESCRIPTION

FIG. 1 is a perspective view of the transfer device;
FIG. 2 is a front elevational view thereof;
FIG. 3 is a left side elevational view thereof;
FIG. 4 is a right side elevational view thereof;
FIG. 5 is a top plan view thereof;
FIG. 6 is a bottom plan view thereof; and,
FIG. 7 is a rear elevational view thereof.

1 Claim, 6 Drawing Sheets

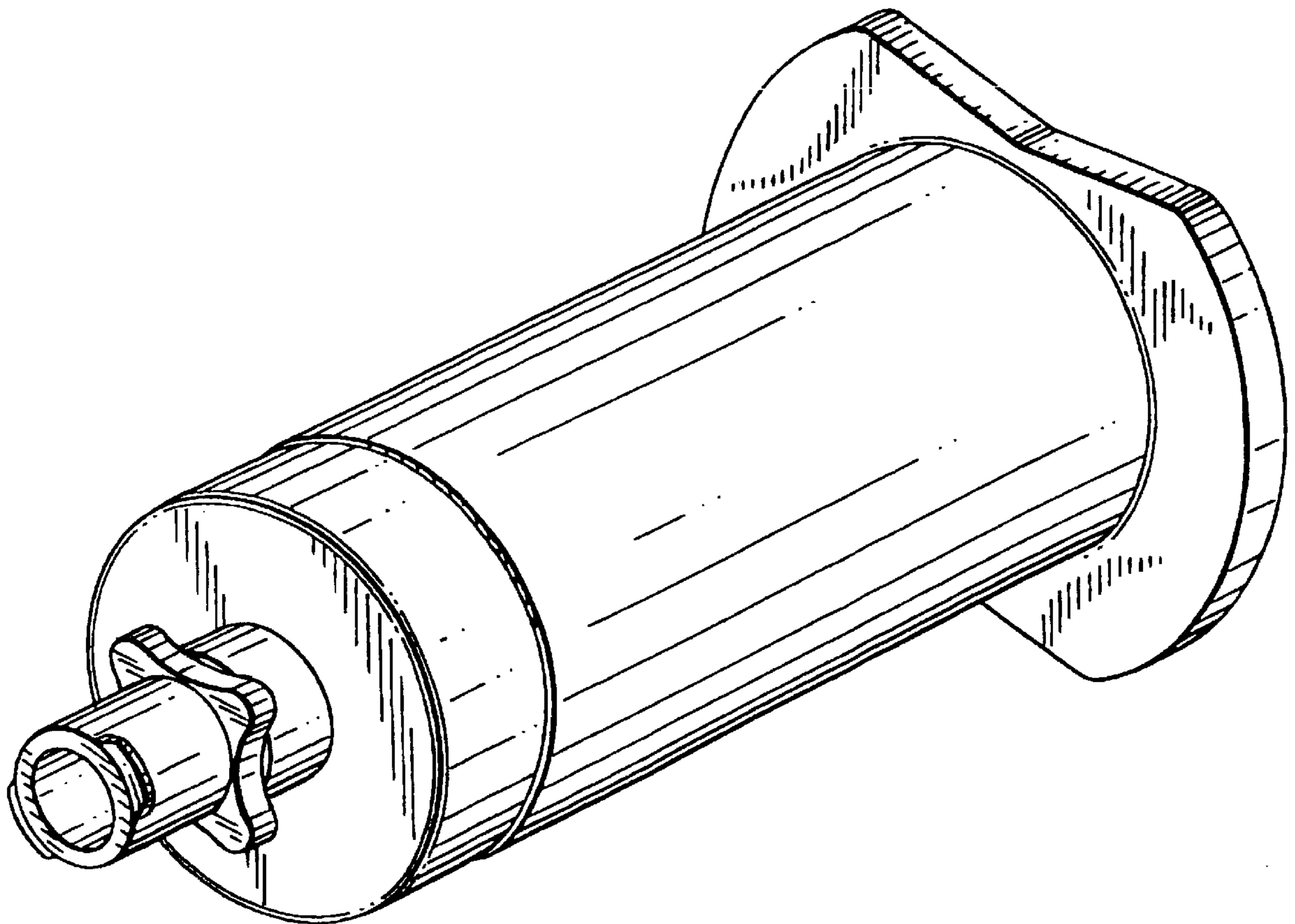

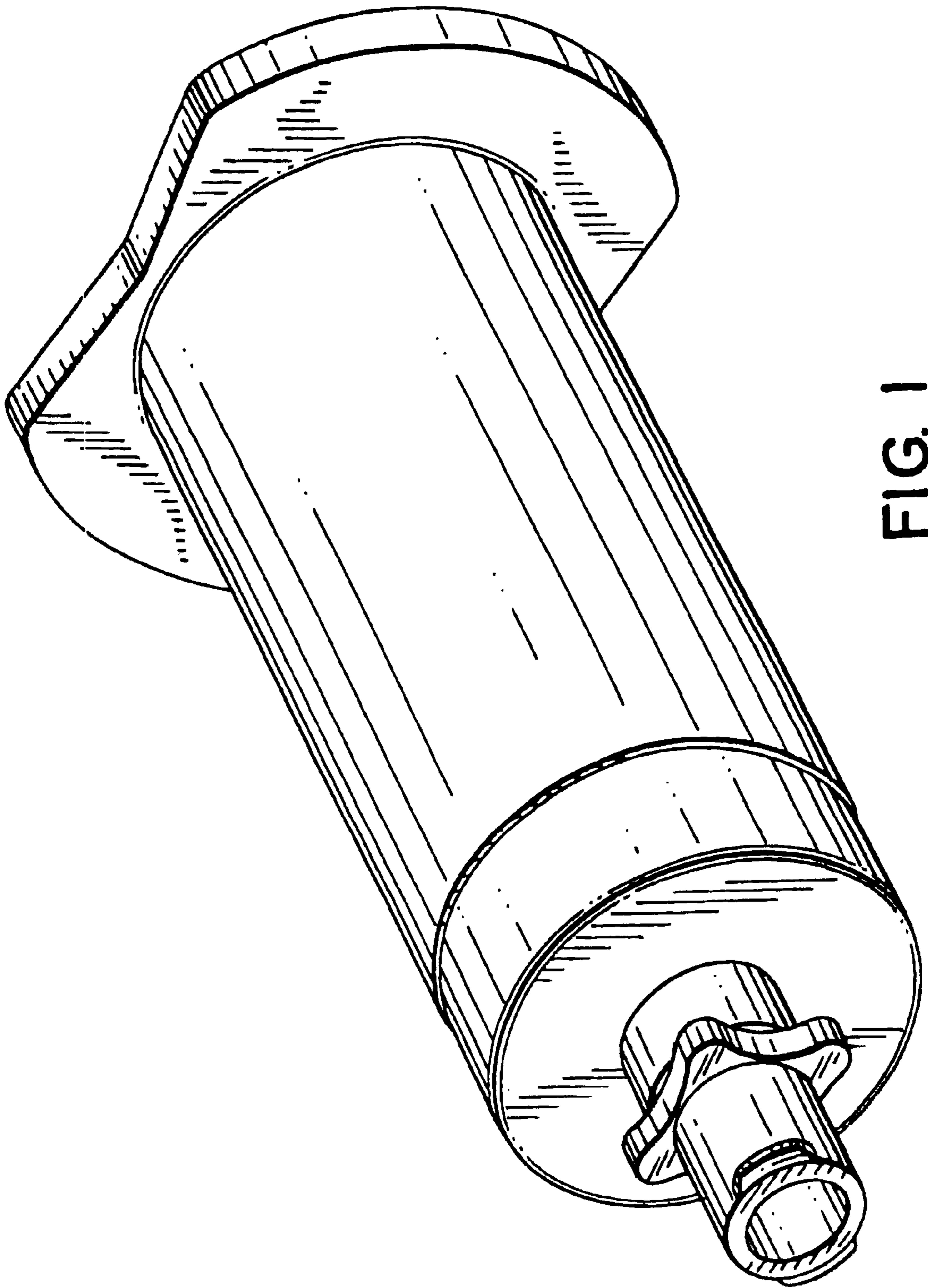

FIG. 1

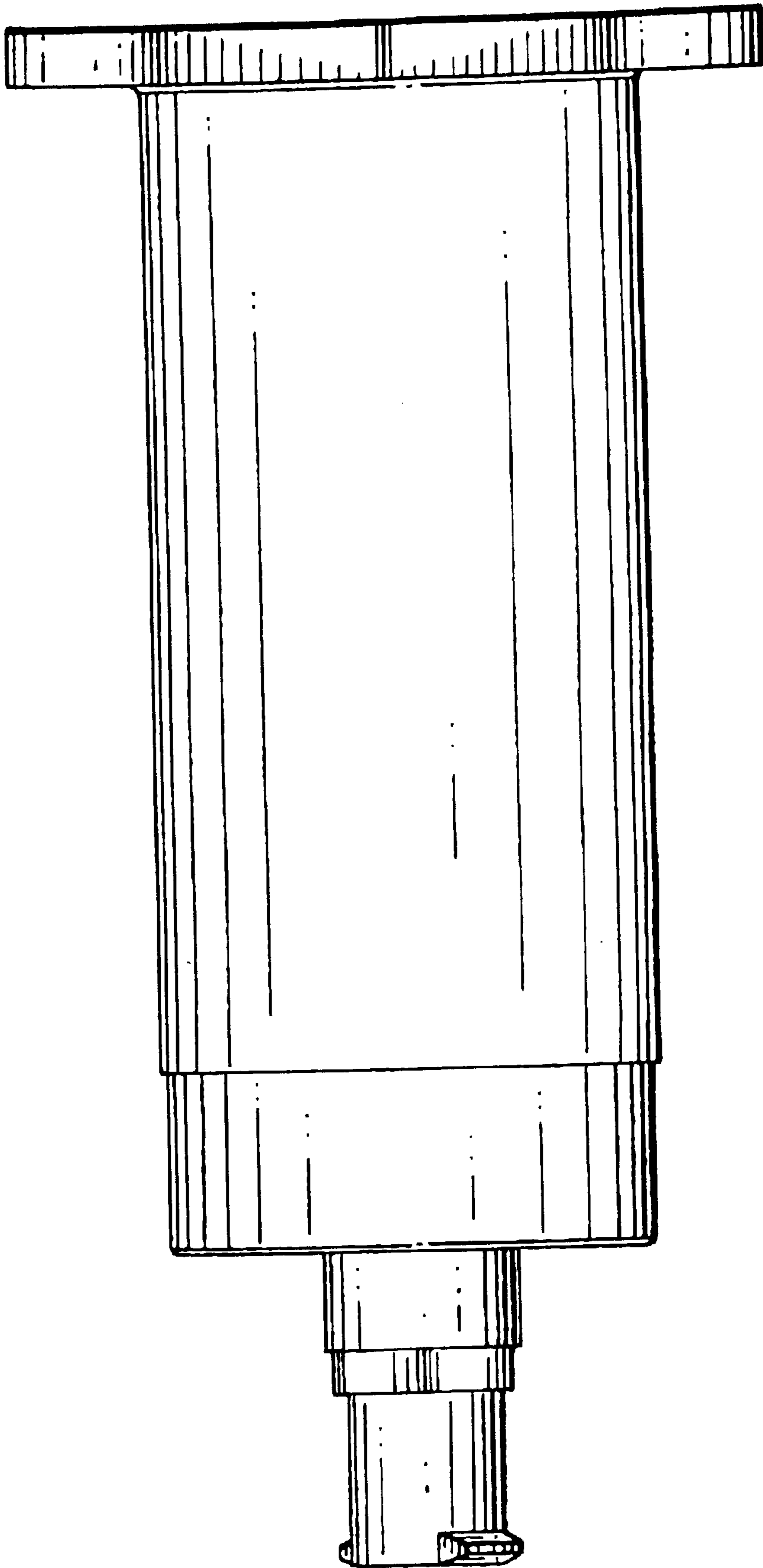

FIG. 2

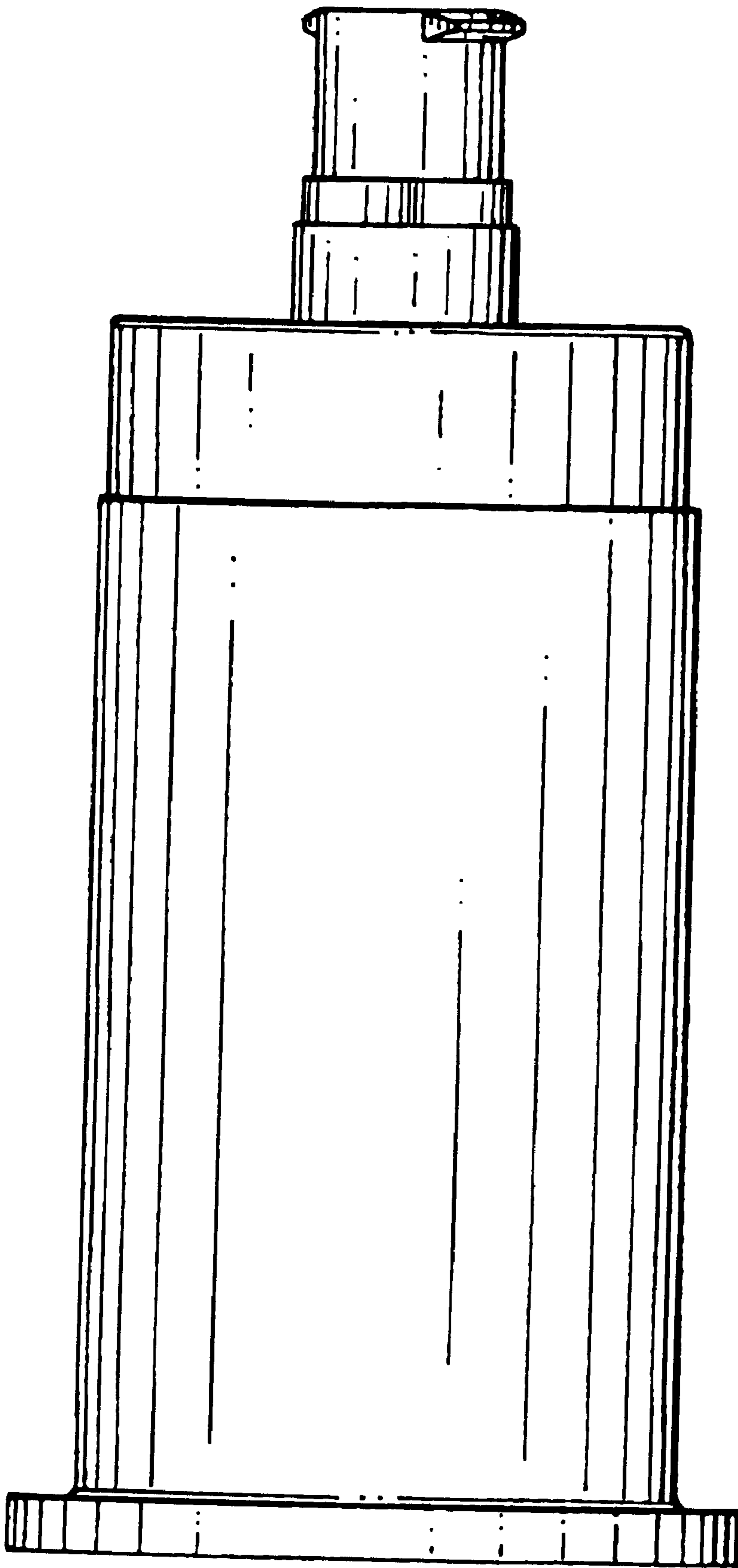

FIG. 3

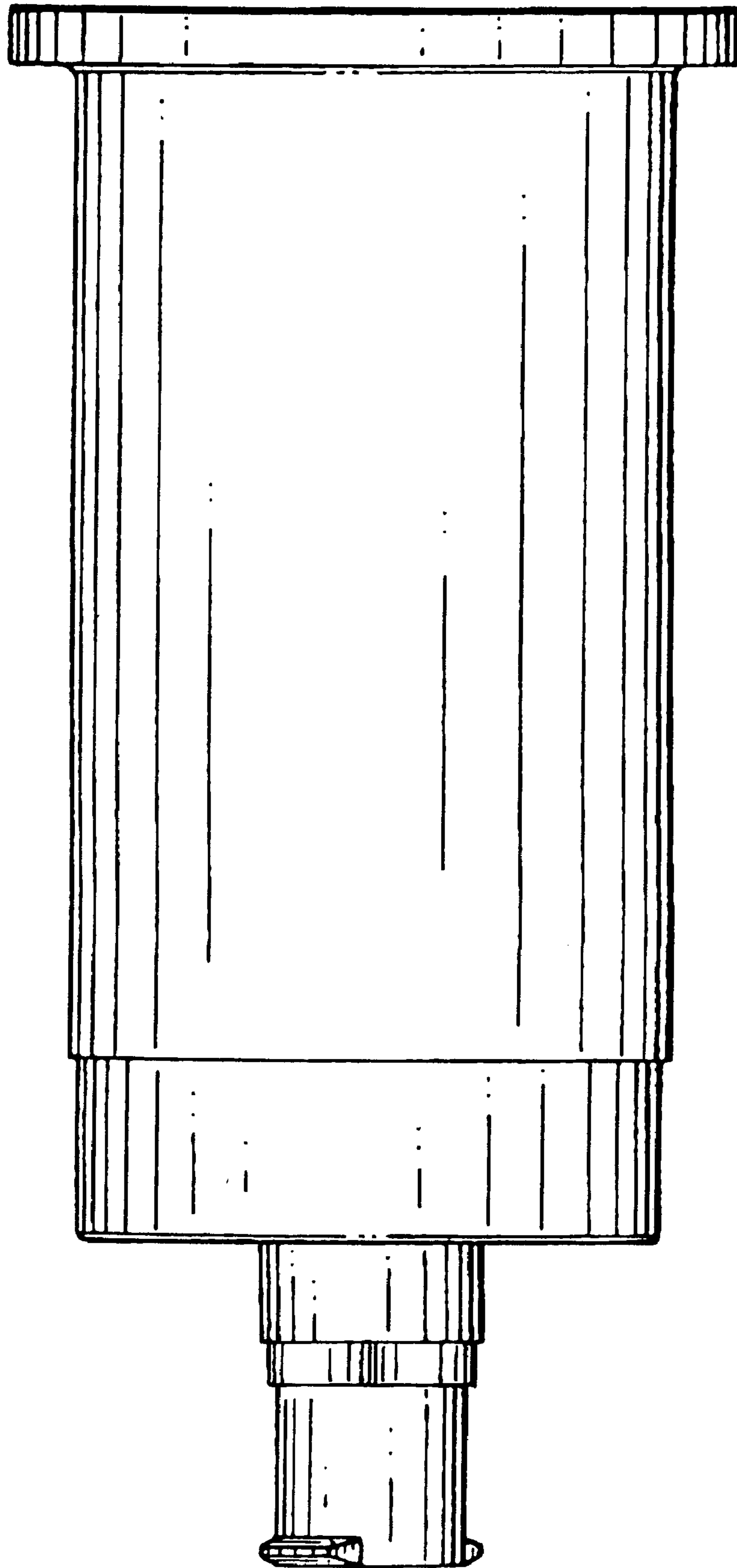

FIG. 4

FIG. 5

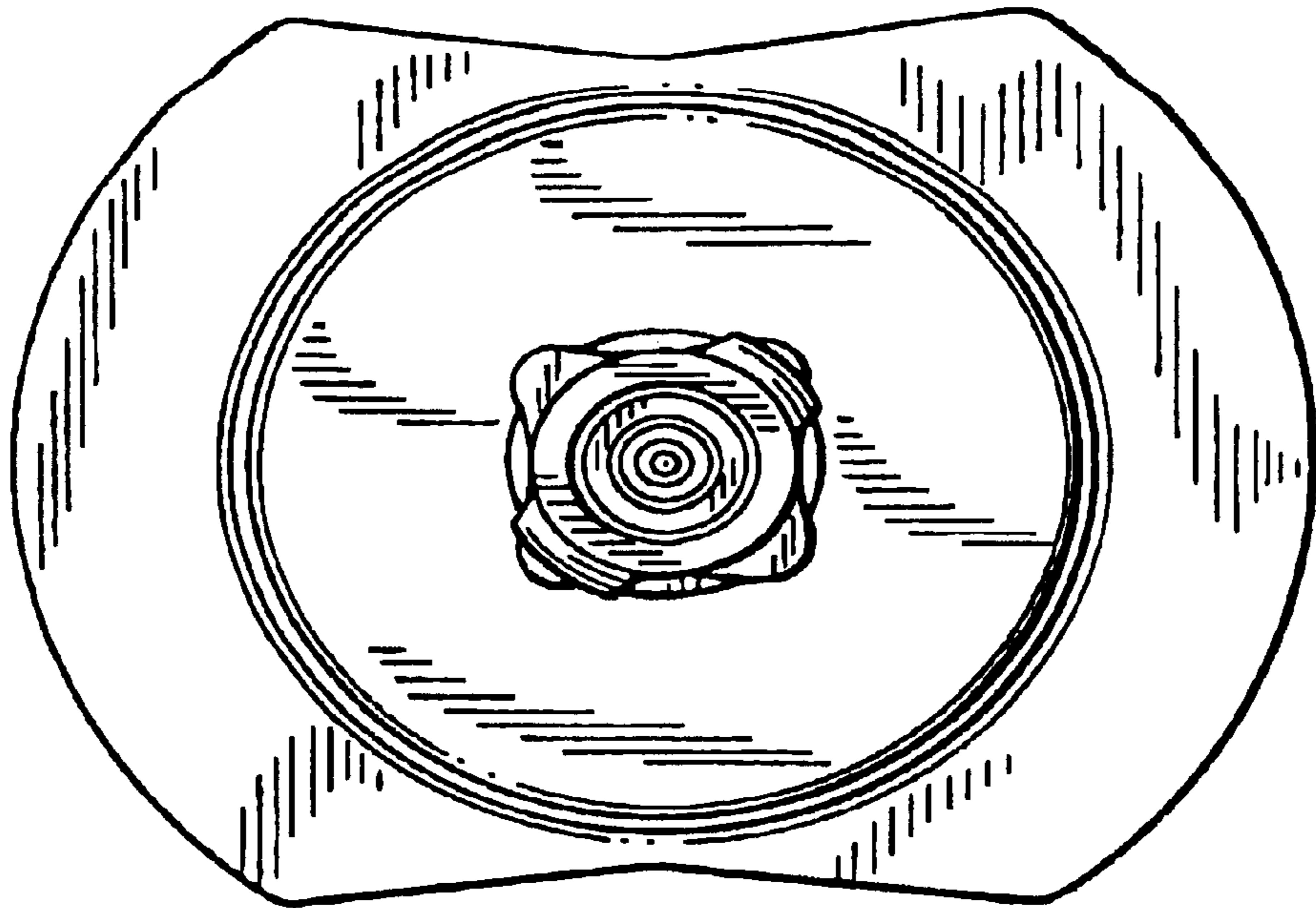
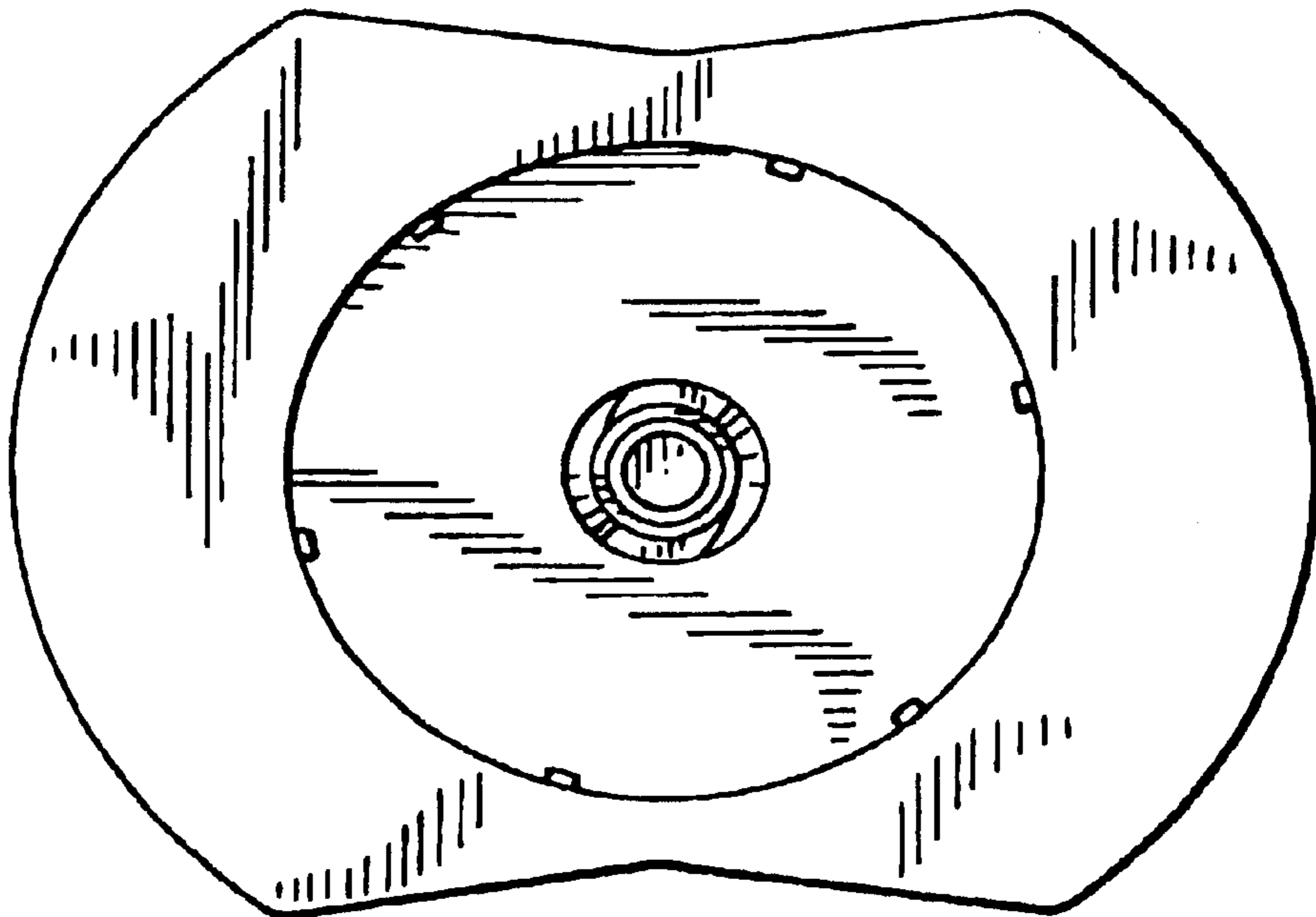

FIG. 6



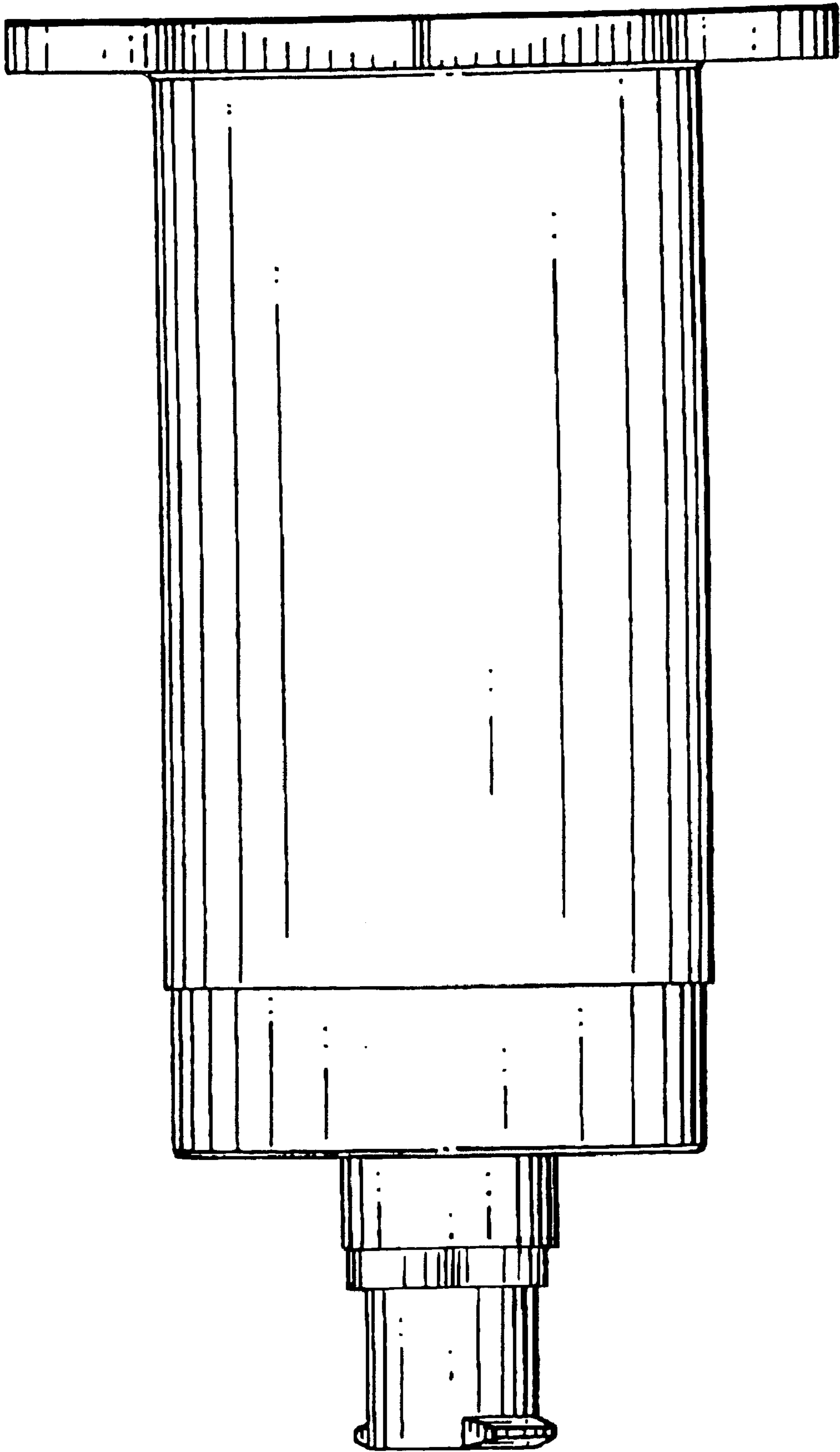

FIG. 7