



US00D460180S

(12) **United States Design Patent**  
**Swenson**

(10) **Patent No.:** **US D460,180 S**

(45) **Date of Patent:** **\*\* Jul. 9, 2002**

(54) **TRANSFER DEVICE**

(75) **Inventor:** **Kirk D. Swenson**, Wayne, NJ (US)

(73) **Assignee:** **Becton, Dickinson and Company**,  
Franklin Lakes, NJ (US)

(\*\*) **Term:** **14 Years**

(21) **Appl. No.:** **29/146,169**

(22) **Filed:** **Aug. 7, 2001**

(51) **LOC (7) Cl.** ..... **24-02**

(52) **U.S. Cl.** ..... **D24/130; D24/108; D24/129**

(58) **Field of Search** ..... **D24/130, 129,**  
**D24/112, 114, 167, 169, 108; 604/411,**  
**6.15, 7, 8, 198, 263, 533, 535, 539; 600/576,**  
**578, 573**

(56) **References Cited**

**U.S. PATENT DOCUMENTS**

D303,013 S \* 8/1989 Konopka ..... D24/129

D307,796 S \* 5/1990 Hanifl et al. .... D24/130  
4,991,601 A \* 2/1991 Kasai et al. .... 600/576  
D323,710 S \* 2/1992 Kasai et al. .... D24/130  
D408,079 S \* 4/1999 Ellis ..... D24/108

\* cited by examiner

*Primary Examiner*—Ian Simmons

(74) *Attorney, Agent, or Firm*—Nanette S. Thomas

(57) **CLAIM**

The ornamental design of a transfer device, as shown.

**DESCRIPTION**

FIG. 1 is a perspective view of the transfer device;  
FIG. 2 is a front elevational view thereof;  
FIG. 3 is a left side elevational view thereof;  
FIG. 4 is a right side elevational view thereof;  
FIG. 5 is a top plan view thereof;  
FIG. 6 is a bottom plan view thereof; and,  
FIG. 7 is a rear elevational view thereof.

**1 Claim, 6 Drawing Sheets**

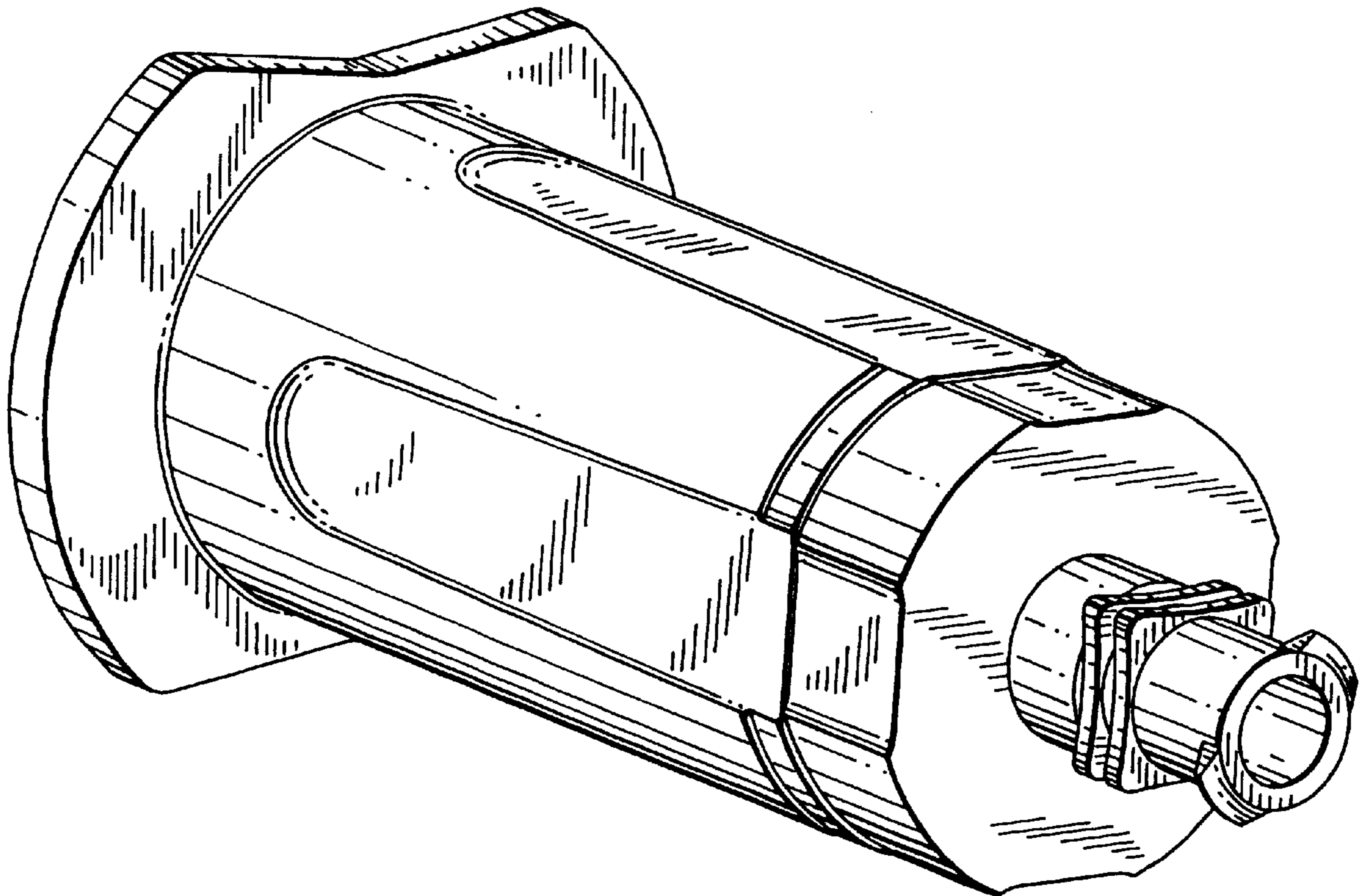

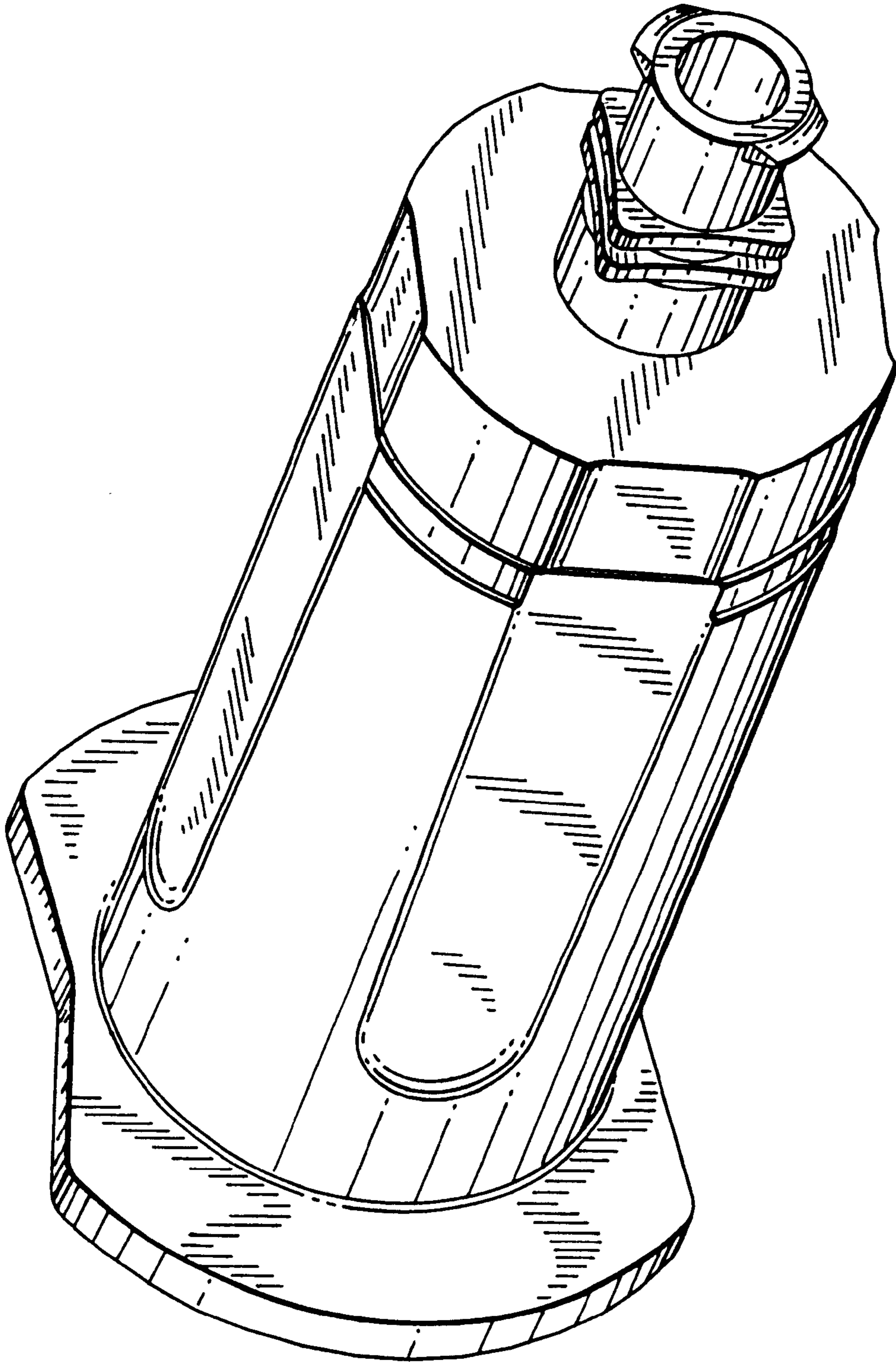

FIG. 1

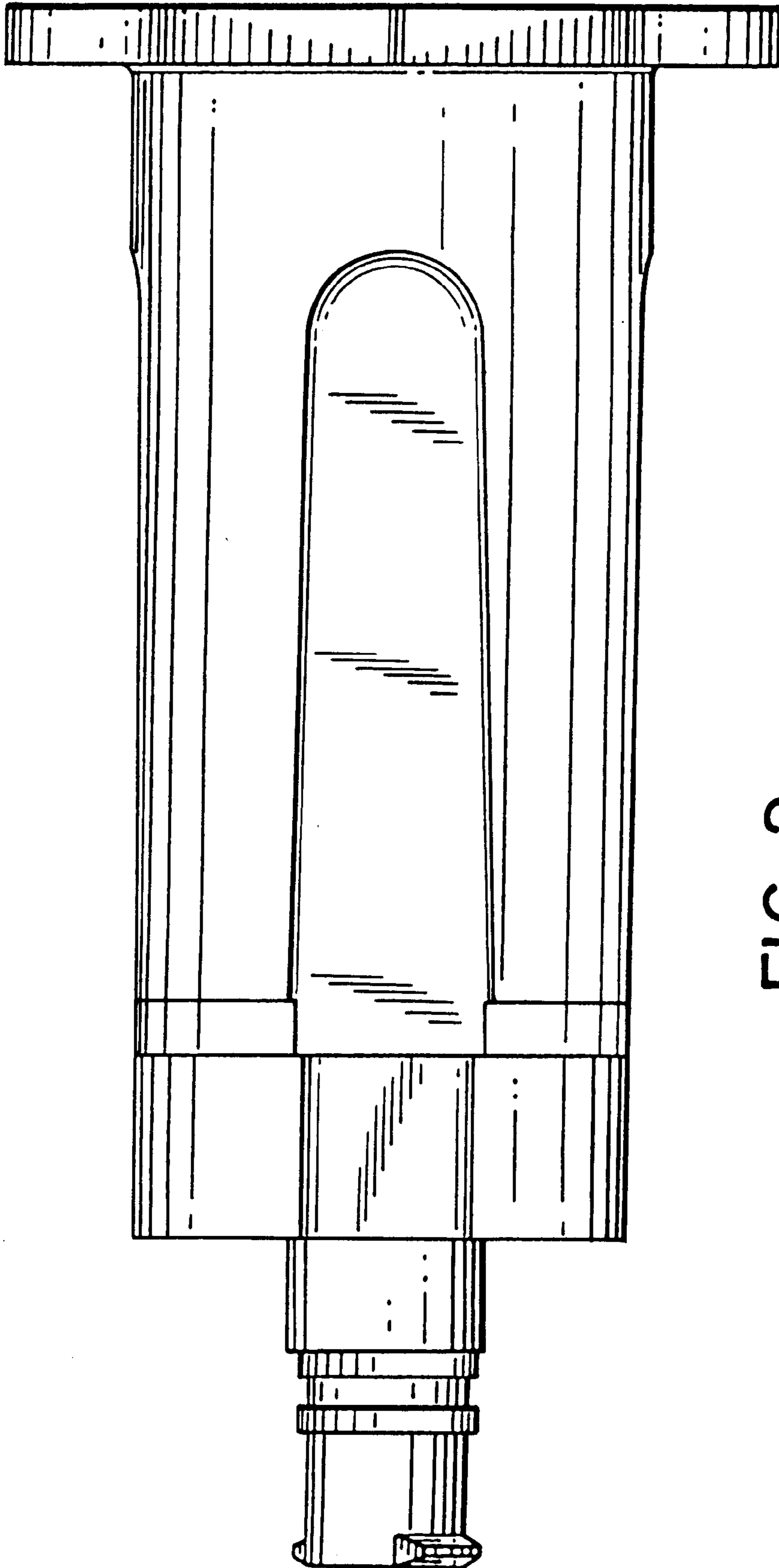

FIG. 2

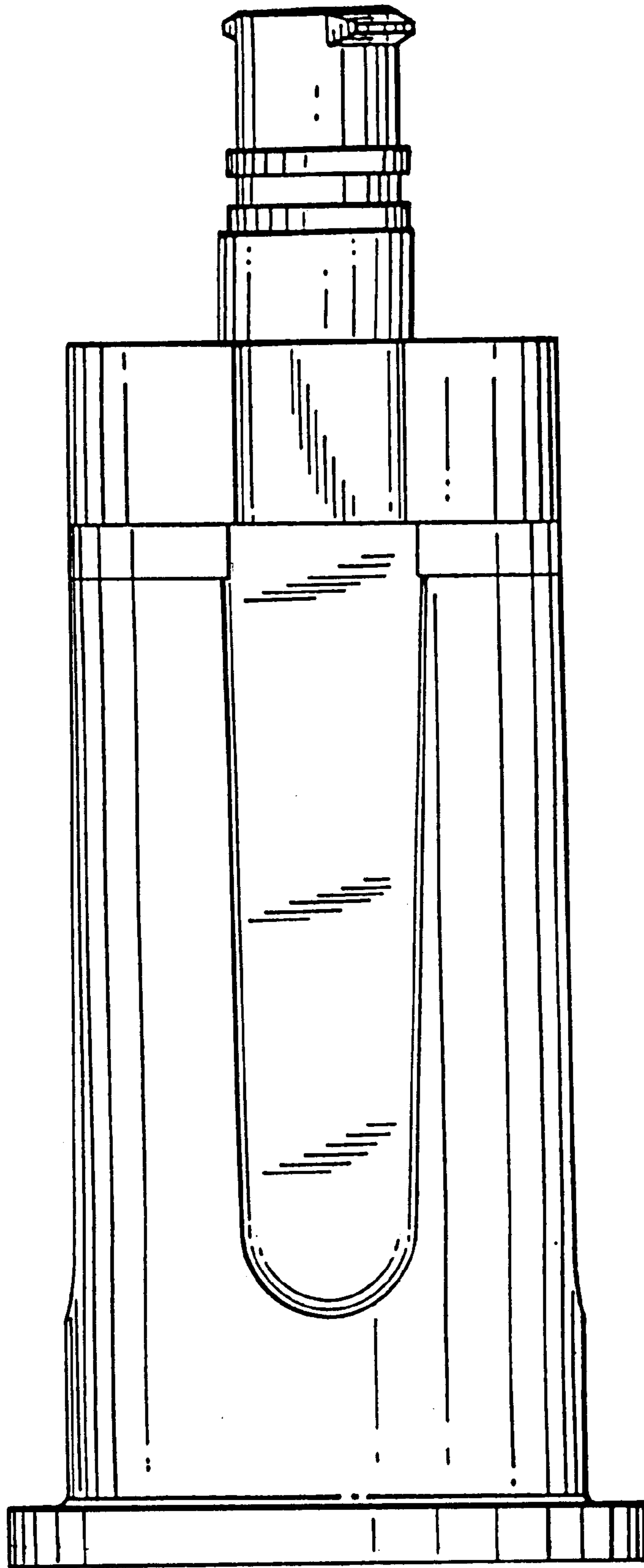

FIG. 3

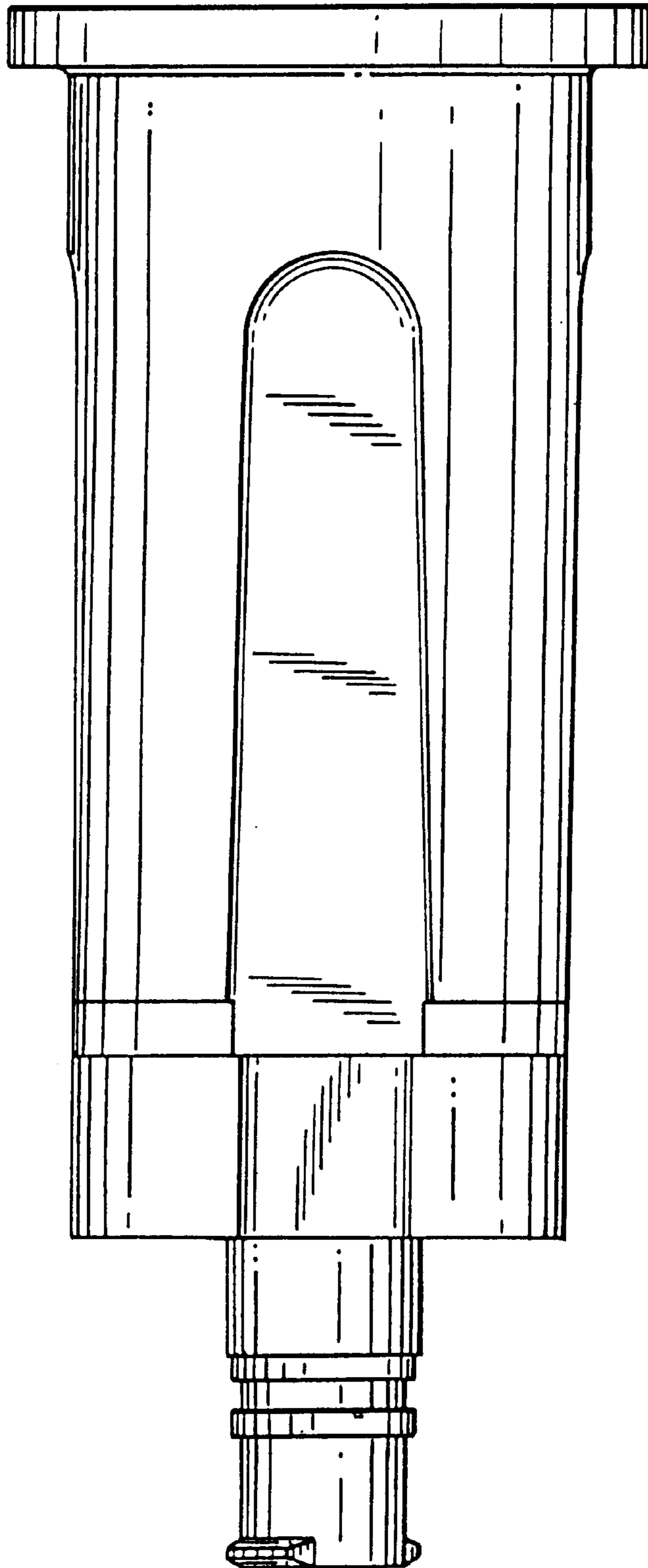

FIG. 4



FIG. 5

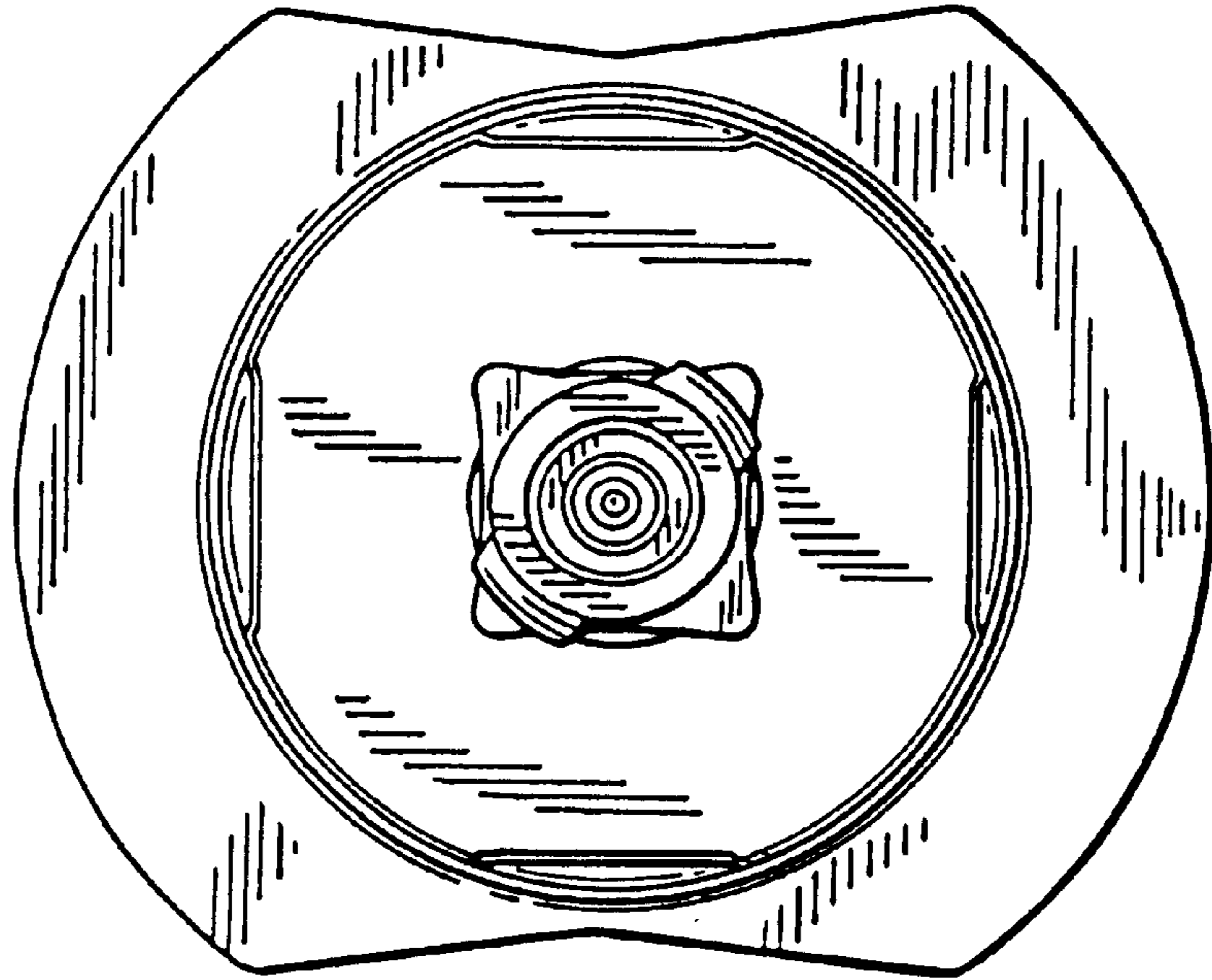
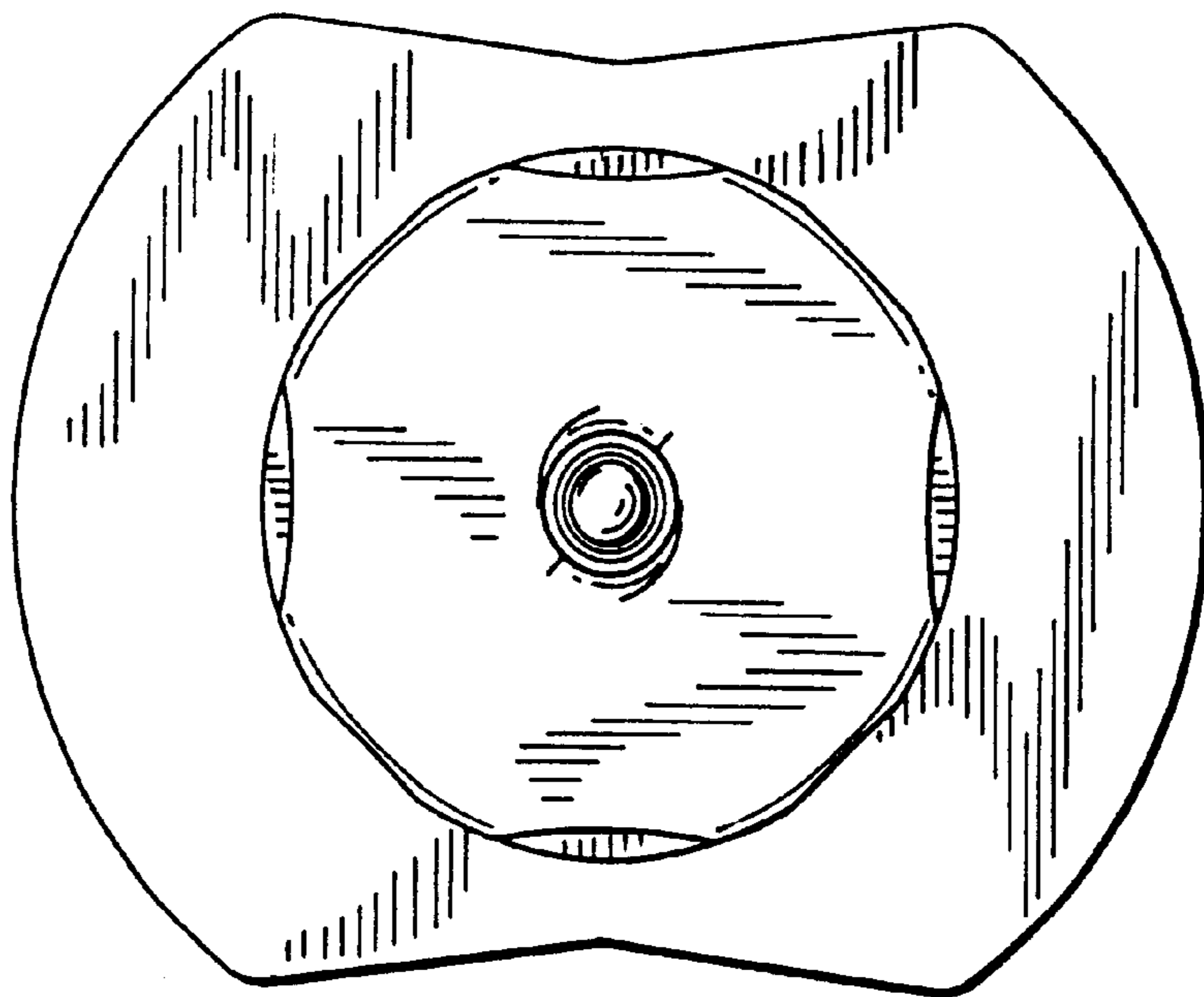

FIG. 6



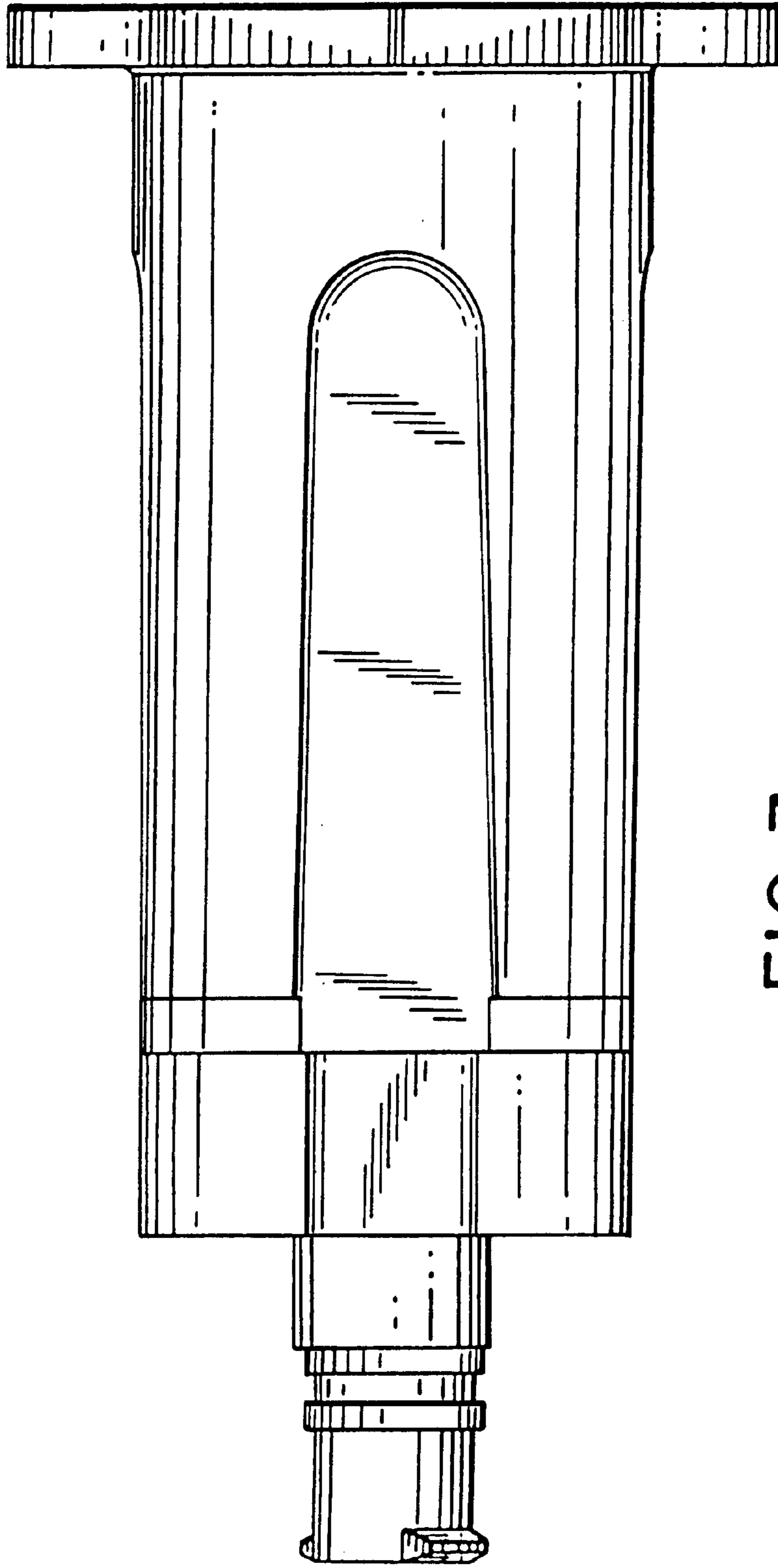

FIG. 7