

US00D460142S

(12) **United States Design Patent**
West

(10) **Patent No.:** **US D460,142 S**

(45) **Date of Patent:** **** Jul. 9, 2002**

(54) **FIREARM RECOIL PAD**

(76) Inventor: **Jack L. West**, 1220 W. 5th, P.O. Box 427, Arlington, OR (US) 97812

(**) Term: **14 Years**

(21) Appl. No.: **29/129,881**

(22) Filed: **Sep. 22, 2000**

(51) **LOC (7) Cl.** **22-01**

(52) **U.S. Cl.** **D22/111**

(58) **Field of Search** D22/100, 103,
D22/108, 111, 199; 42/70.03, 71.01, 73,
74

(56) **References Cited**

U.S. PATENT DOCUMENTS

935,822 A	*	10/1909	Schmidt	42/74
2,432,519 A	*	12/1947	Garand	42/71.01
3,514,889 A	*	6/1970	Pachmayr	42/74
3,618,248 A	*	11/1971	Into et al.	42/71.01
D225,007 S	*	10/1972	Albright, Jr.	D22/111
D283,042 S	*	3/1986	Holland et al.	D22/103

OTHER PUBLICATIONS

Skeet Shooting Review Advertisement, "KICK-EEZ"; Oct. 1998; 1 page.

* cited by examiner

Primary Examiner—Louis S. Zarfaz
Assistant Examiner—Monica A. Weingart
(74) *Attorney, Agent, or Firm*—Wells St. John P.S.

(57) **CLAIM**

The ornamental design for a firearm recoil pad, as shown and described.

DESCRIPTION

FIG. 1 is a prospective view of a firearm recoil pad showing my new design;
FIG. 2 is a side elevation view thereof, the opposite side being a mirror image;
FIG. 3 is a top plan view thereof;
FIG. 4 is a bottom plan view thereof;
FIG. 5 is an end elevation as seen from the right in FIG. 3;
FIG. 6 is an opposed end view as seen from the left in FIG. 3;
FIG. 7 is a prospective view of an alternate form of my design;
FIG. 8 is a side elevation view of the alternate form, the opposite side being a mirror image;
FIG. 9 is a top plan view of the alternate form;
FIG. 10 is a bottom plan view of the alternate form;
FIG. 11 is an end view of the alternate form as seen from the right in FIG. 9; and,
FIG. 12 is an end elevation view of the alternate form as seen from the left in FIG. 9.

1 Claim, 4 Drawing Sheets

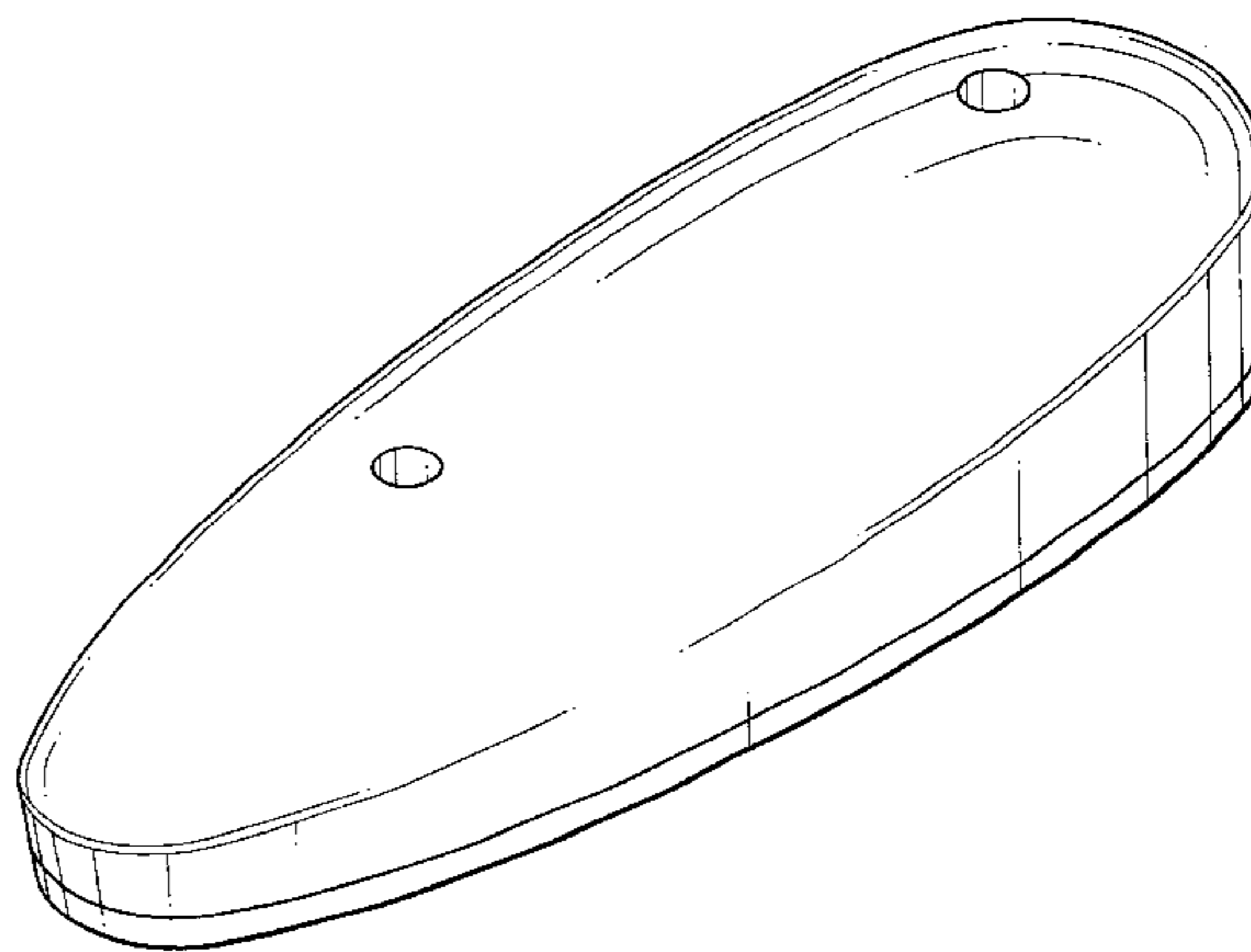
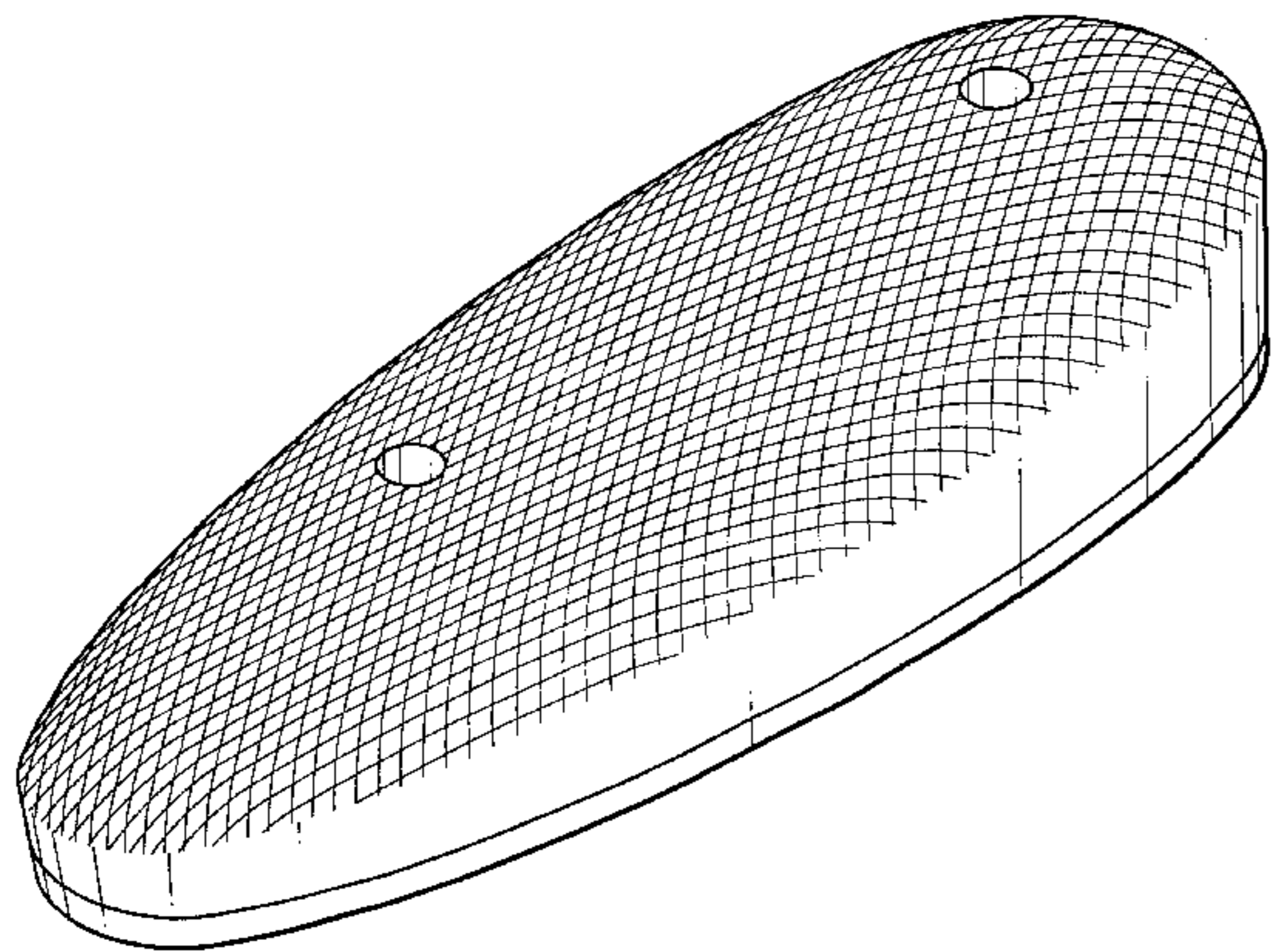

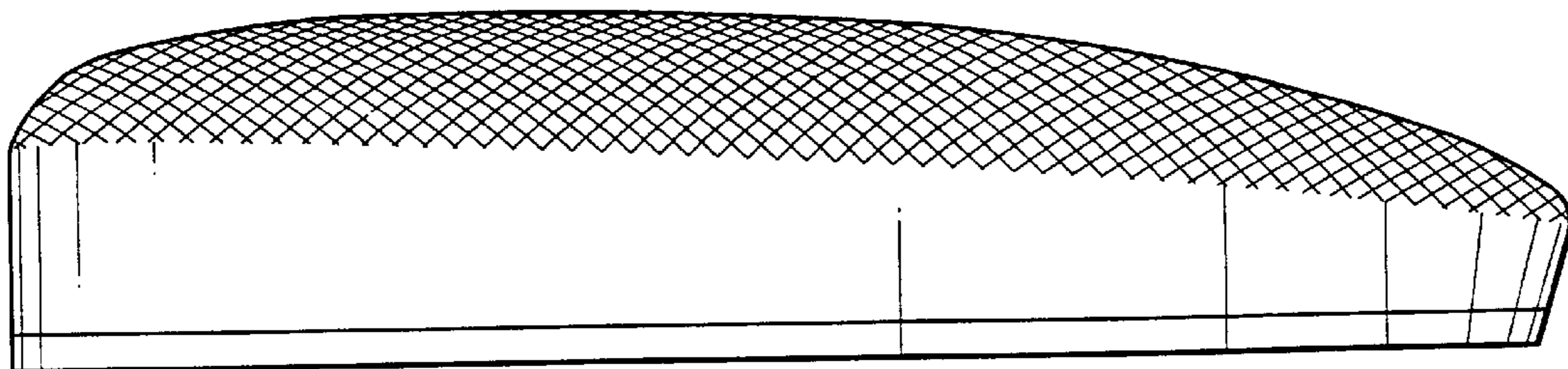
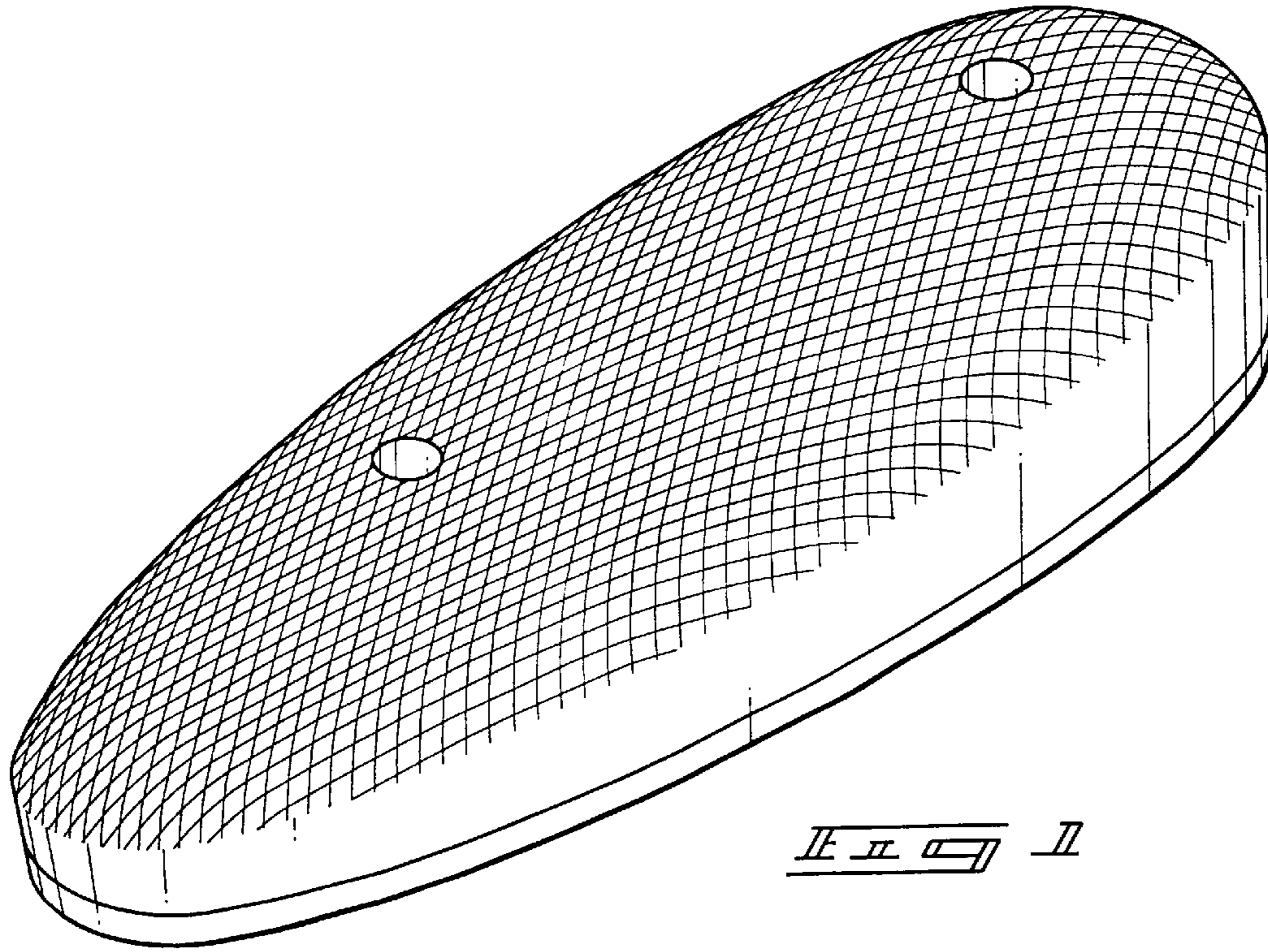

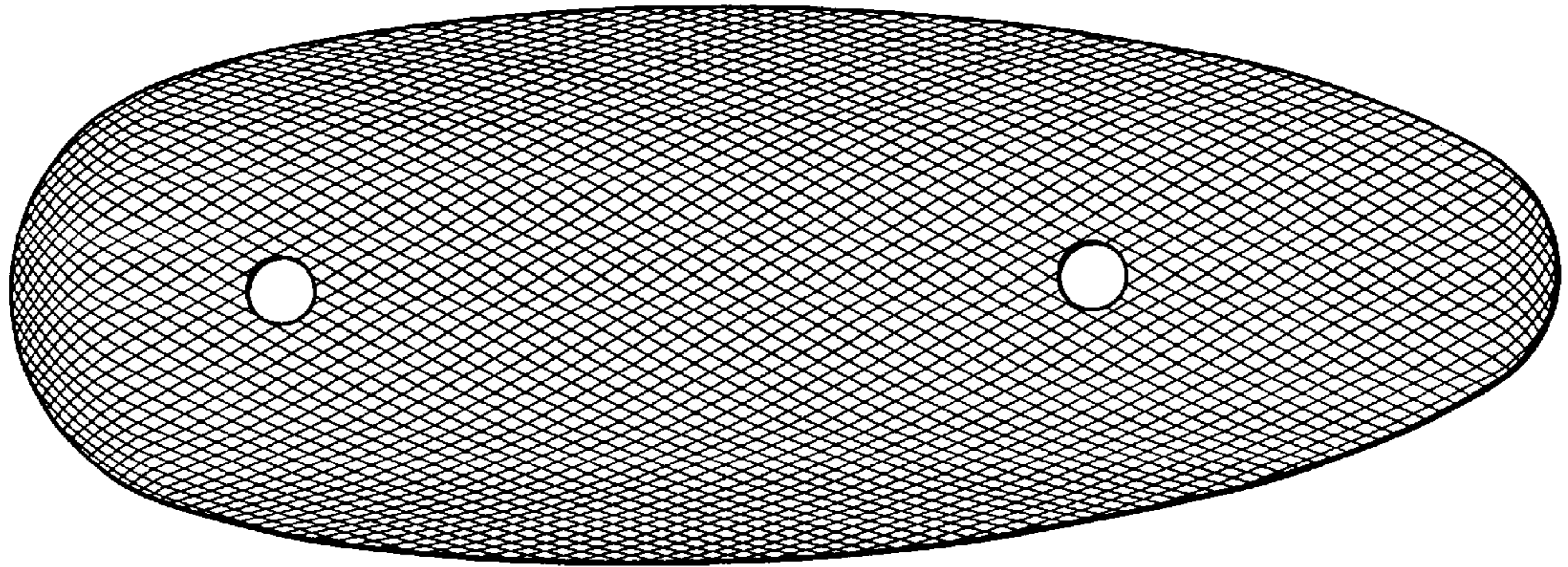

FIG. 3

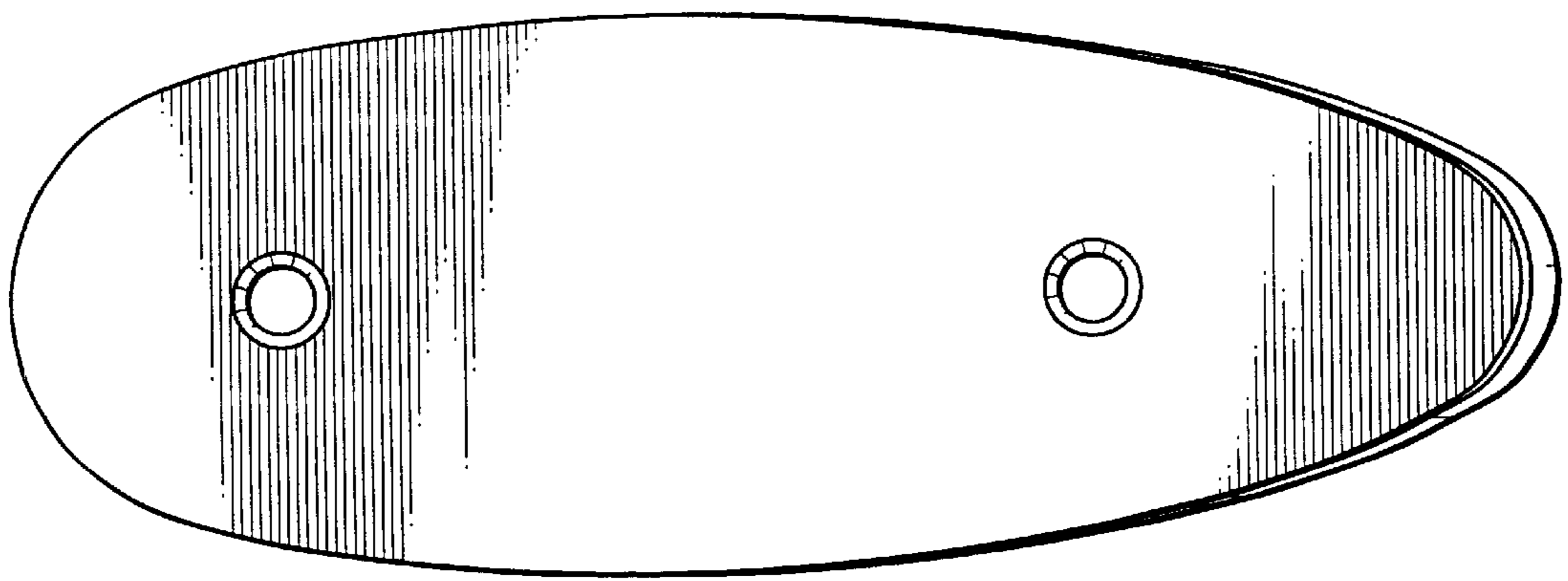

FIG. 4

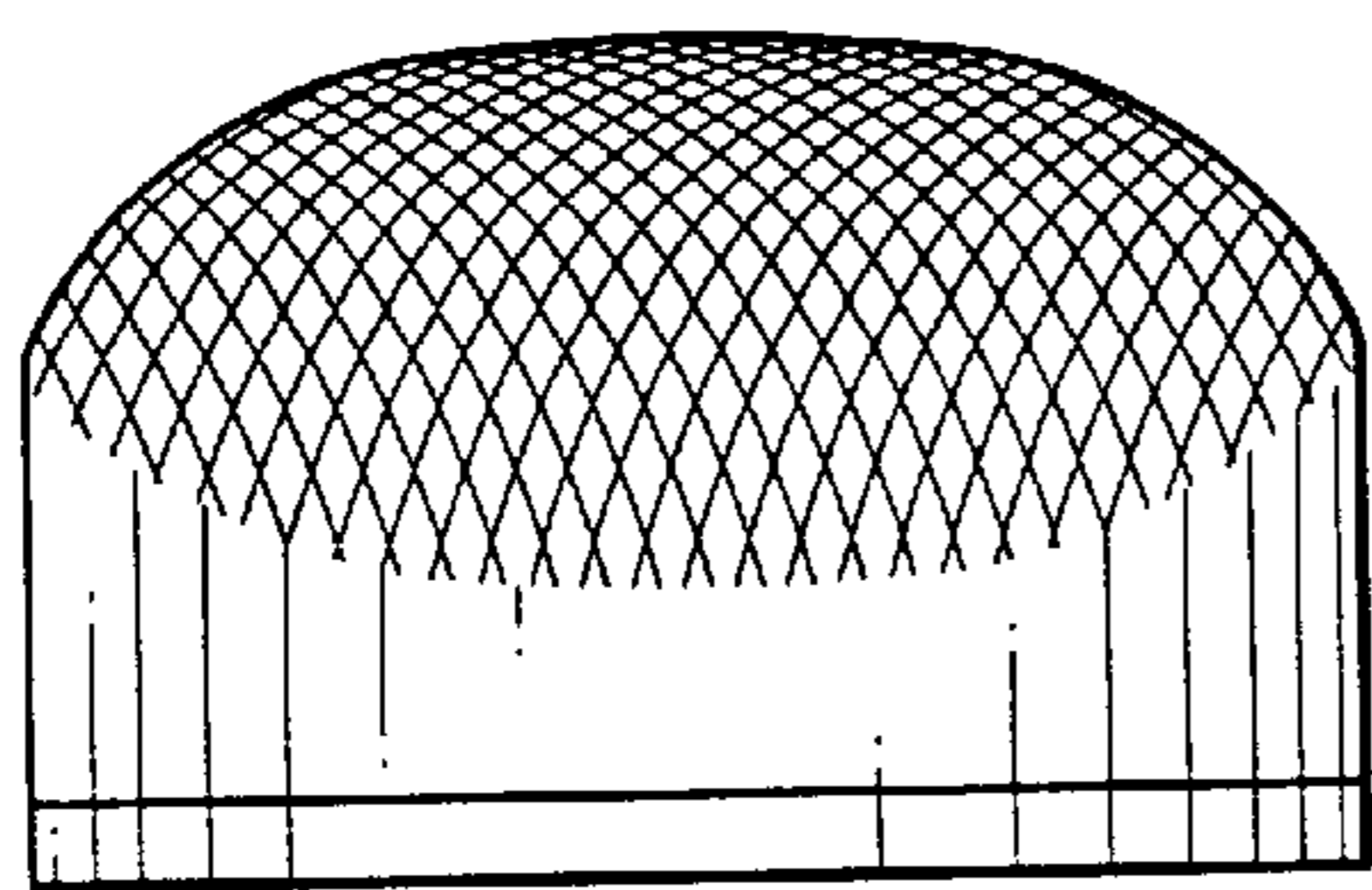

FIG. 5

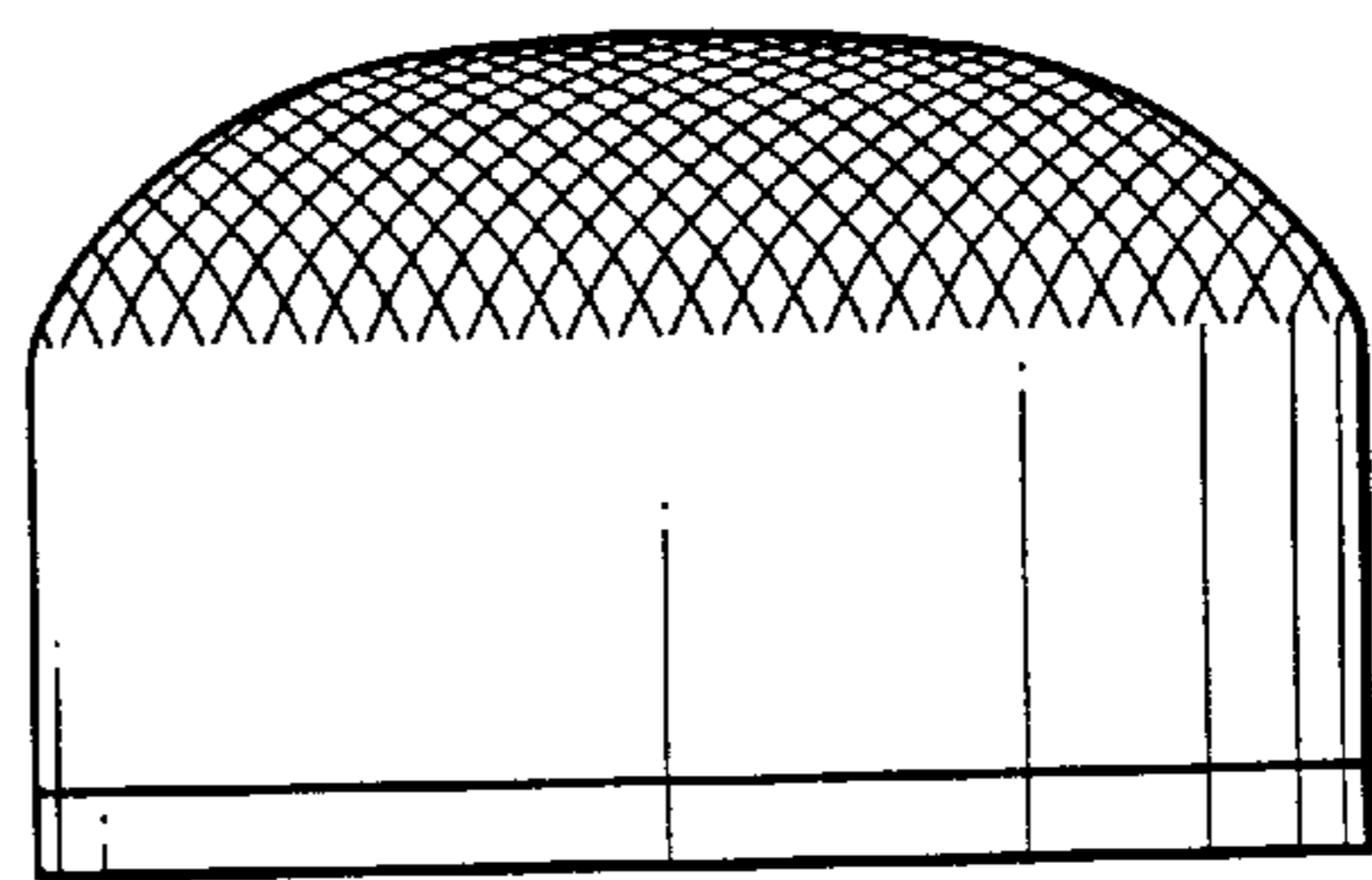
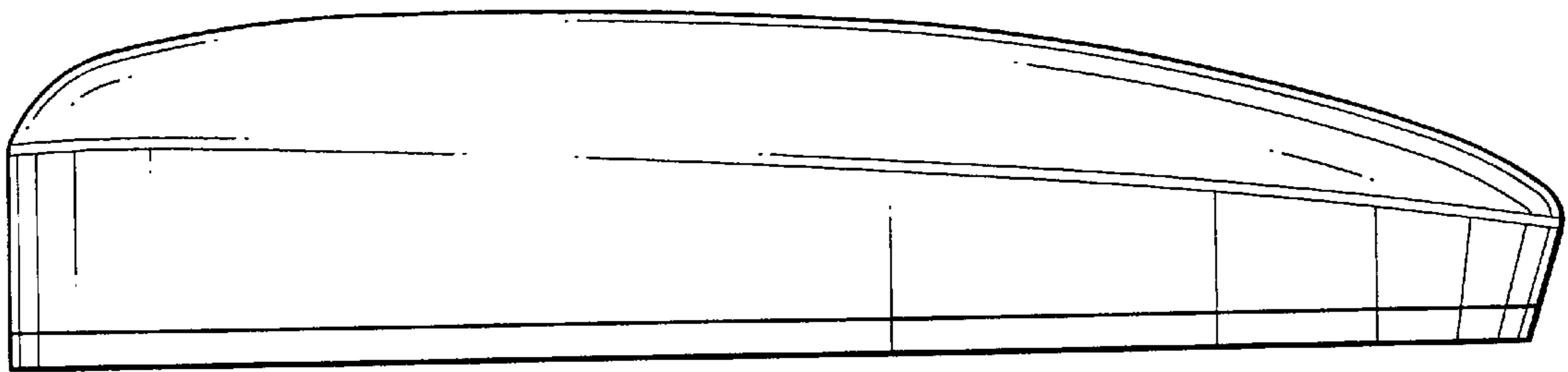
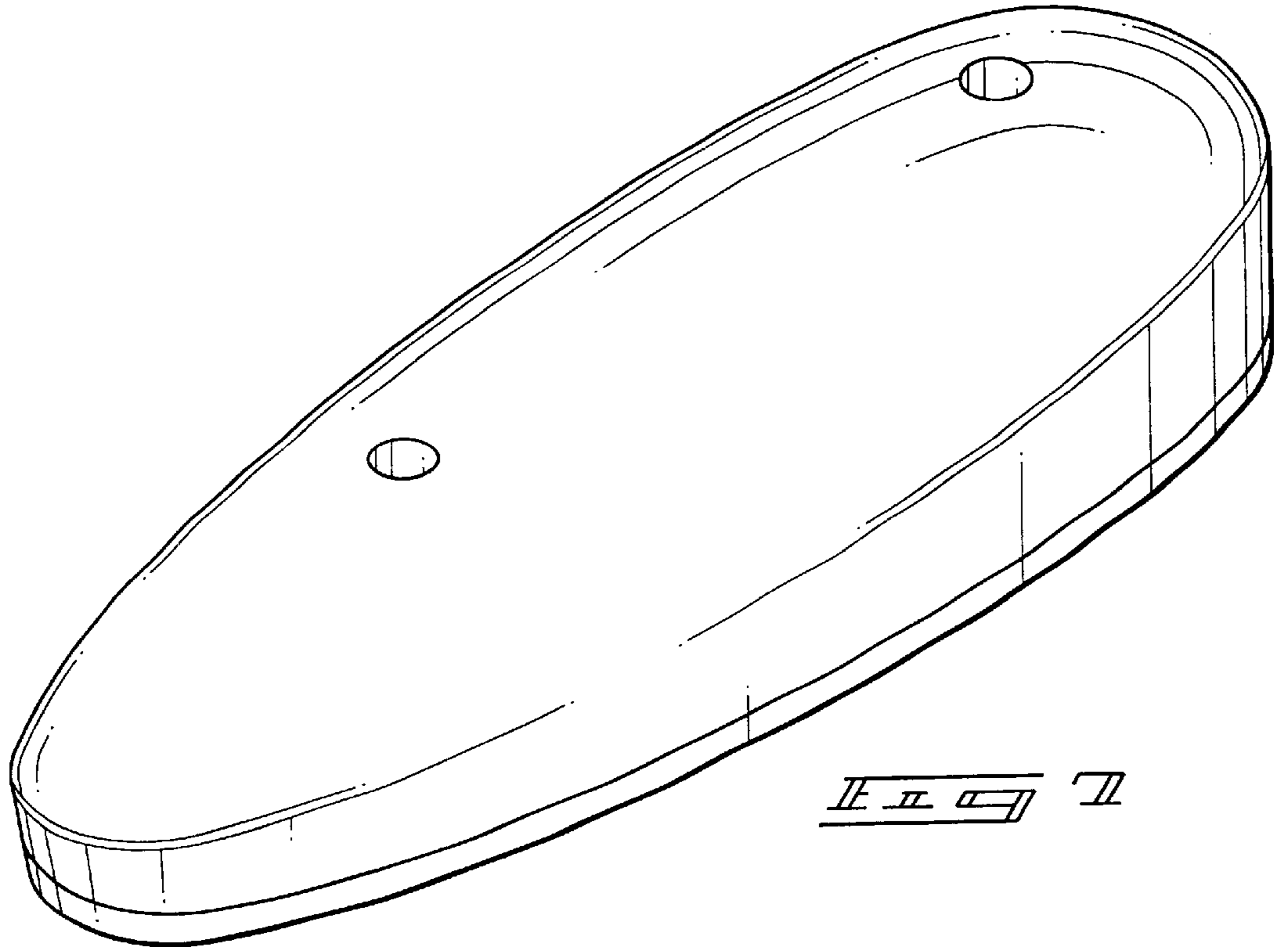

FIG. 6



12

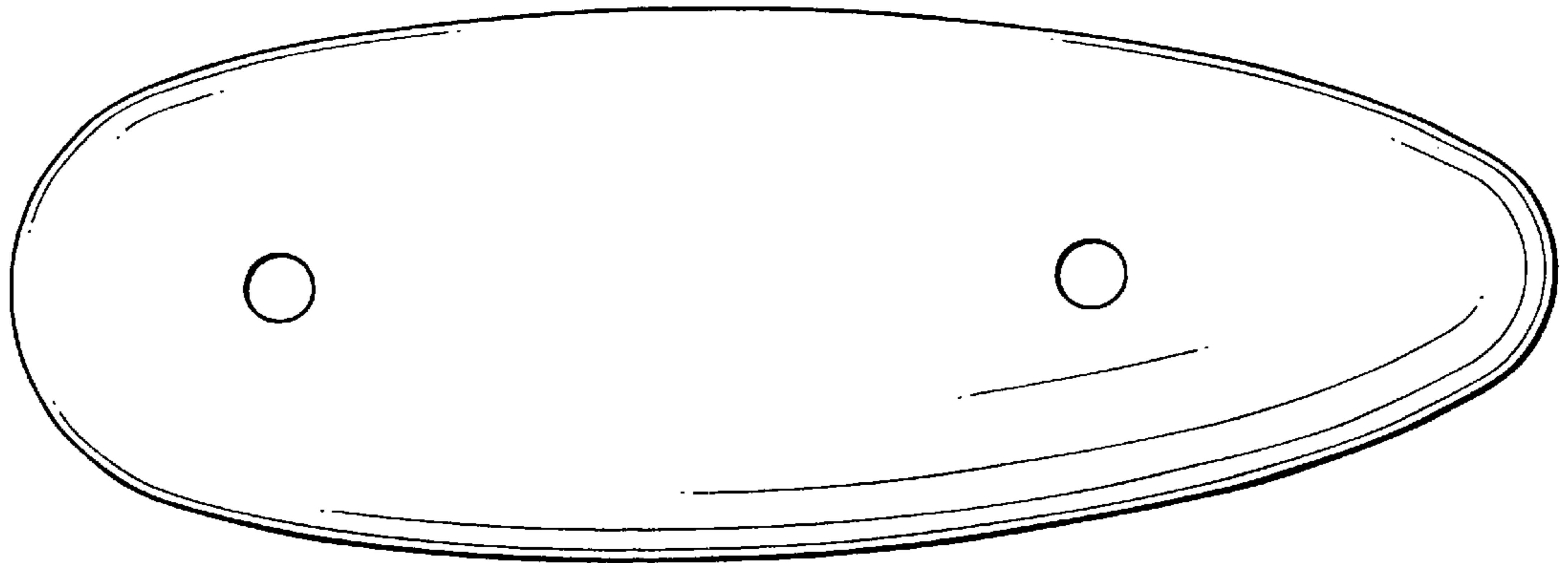

FIG. 9

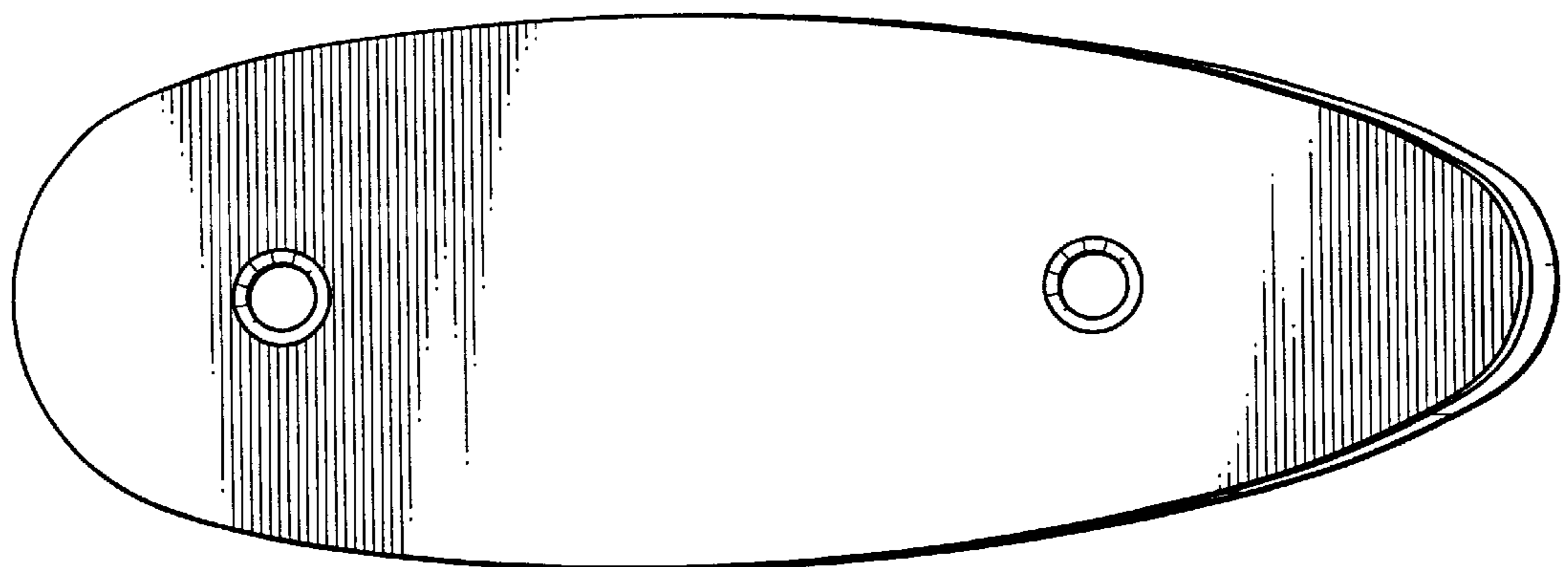

FIG. 10

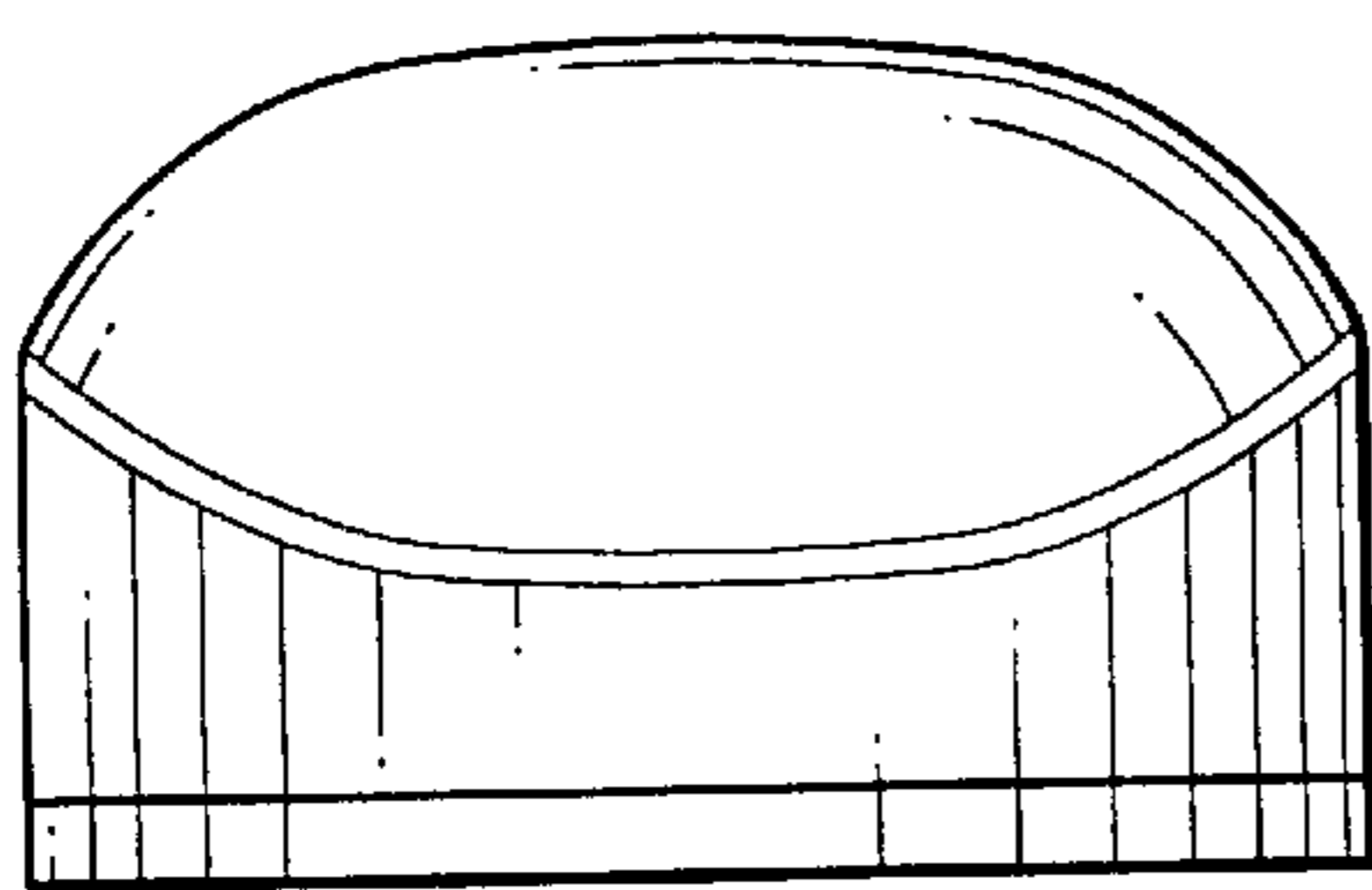

FIG. 11

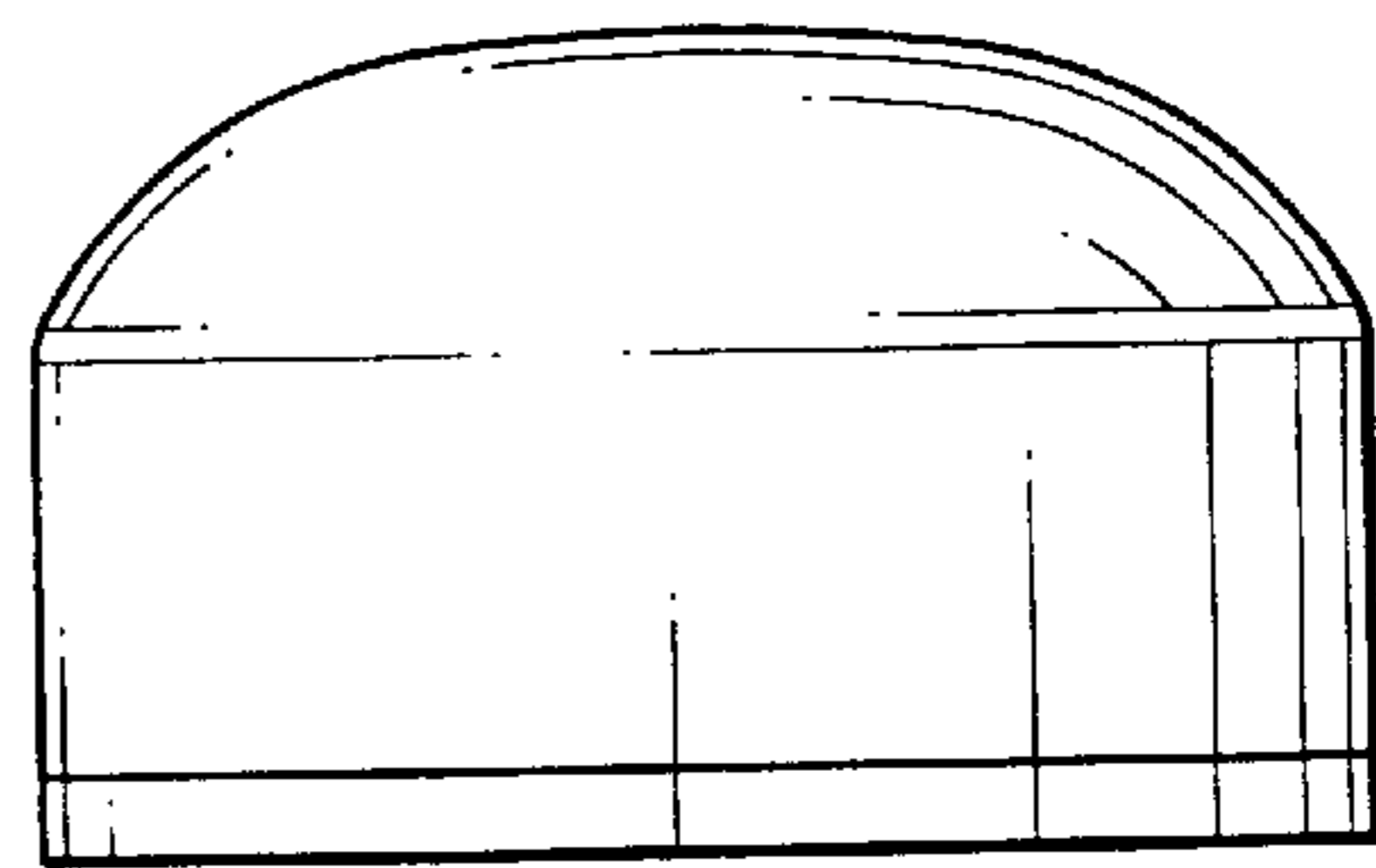

FIG. 12