



US00D460129S

(12) **United States Design Patent**
Barazani et al.

(10) **Patent No.:** **US D460,129 S**

(45) **Date of Patent:** **** Jul. 9, 2002**

(54) **INTERCONNECTABLE PLAY CUBE**

D445,148 S * 7/2001 McIntosh D21/500

(76) Inventors: **Uri Barazani; Golda Barazani; Ran Barazani; Madeleine Barazani; Doreen Barazani; Roy Barazani**, all of 15 Mendes Street, Ramat Gan, 52653 (IL)

* cited by examiner

Primary Examiner—Raphael Barkai
(74) *Attorney, Agent, or Firm*—Christensen O'Connor Johnson Kindness PLLC

(**) Term: **14 Years**

(57) **CLAIM**

The ornamental design for a interconnectable play cube, as shown and described.

(21) Appl. No.: **29/140,258**

(22) Filed: **Apr. 13, 2001**

(51) **LOC (7) Cl.** **21-01**

(52) **U.S. Cl.** **D21/499**

(58) **Field of Search** D21/483–505; D25/113–118; 446/85, 93–96, 102–107, 108–116, 117, 120–122, 124, 125, 127, 128; 52/592.1, 592.2, 592.4

DESCRIPTION

The design relates to an interconnectable play cube. The cube is provided with slots and ribs and round projections, which enable one to connect the cube to similar cubes or to place the cube on top of such other cube. The upper part of the round projection is pivotably connected to the cube.

FIG. 1 is a front view of the interconnectable play cube showing its new design.

FIG. 2 is a side view of the interconnectable play cube shown in FIG. 1;

FIG. 3 is a top view of the interconnectable play cube shown in FIG. 1;

FIG. 4 is a bottom view of the interconnectable play cube shown in FIG. 1;

FIG. 5 is a back view of the interconnectable play cube shown in FIG. 1;

FIG. 6 is a perspective view of the interconnectable play cube shown in FIG. 1; and,

FIG. 7 is a perspective view of the interconnectable play cube shown in FIG. 1.

(56) **References Cited**

U.S. PATENT DOCUMENTS

- 1,894,061 A * 1/1933 Sanders
- 2,132,757 A * 10/1938 Paulsen
- 2,990,640 A * 7/1961 Burnbaum
- 3,139,698 A * 7/1964 Arnold 446/93
- 3,570,169 A * 3/1971 Jacob
- D249,232 S * 9/1978 Van Der Veken D21/500
- D317,477 S * 6/1991 Poulsen D21/500
- D329,066 S * 9/1992 Jarnros D21/500
- D367,504 S * 2/1996 Barzani D21/498
- 5,493,816 A * 2/1996 Willemsen 446/125
- D430,231 S * 8/2000 Sorensen et al. D21/499
- D435,609 S * 12/2000 Sorensen D21/499

1 Claim, 2 Drawing Sheets

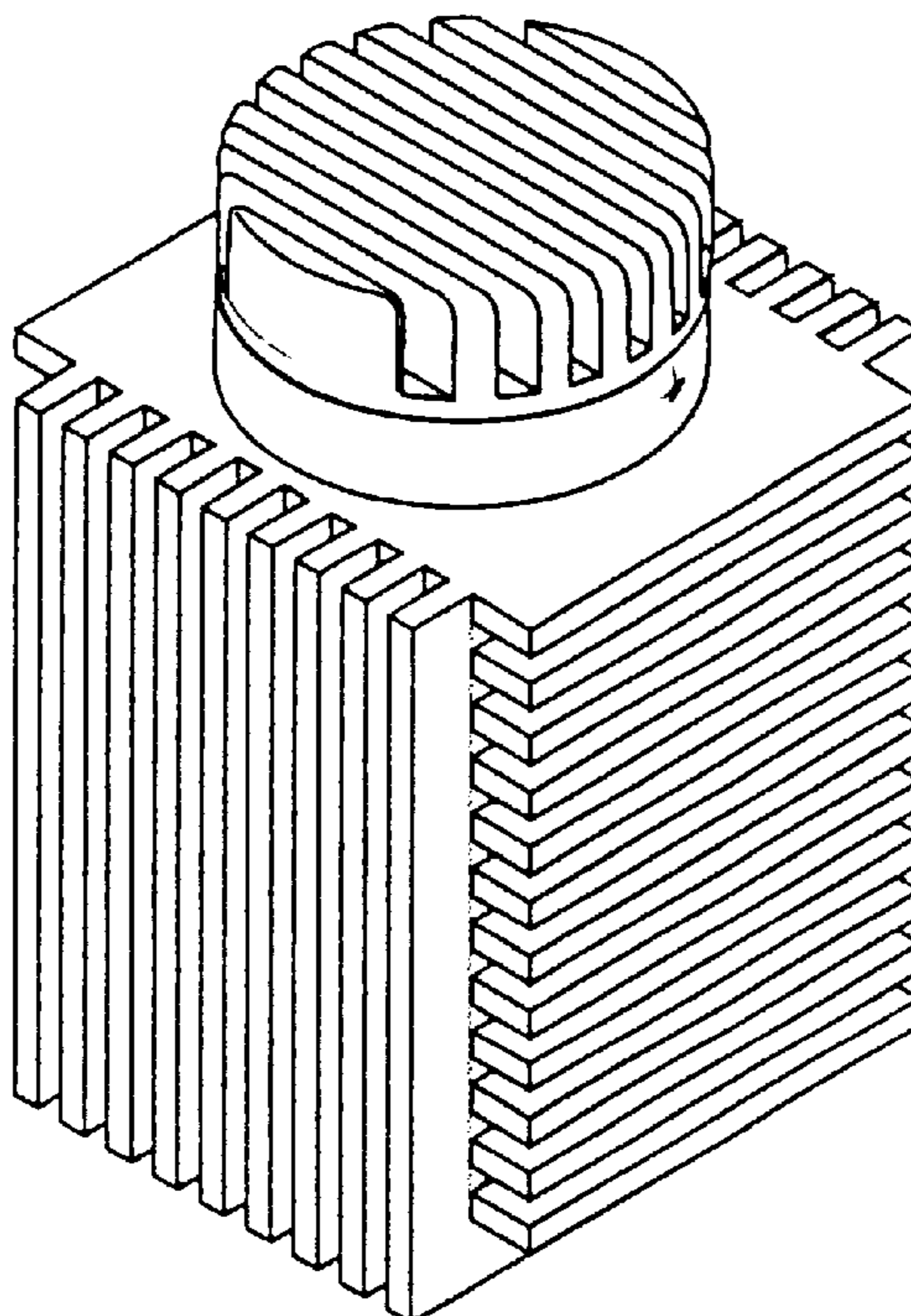

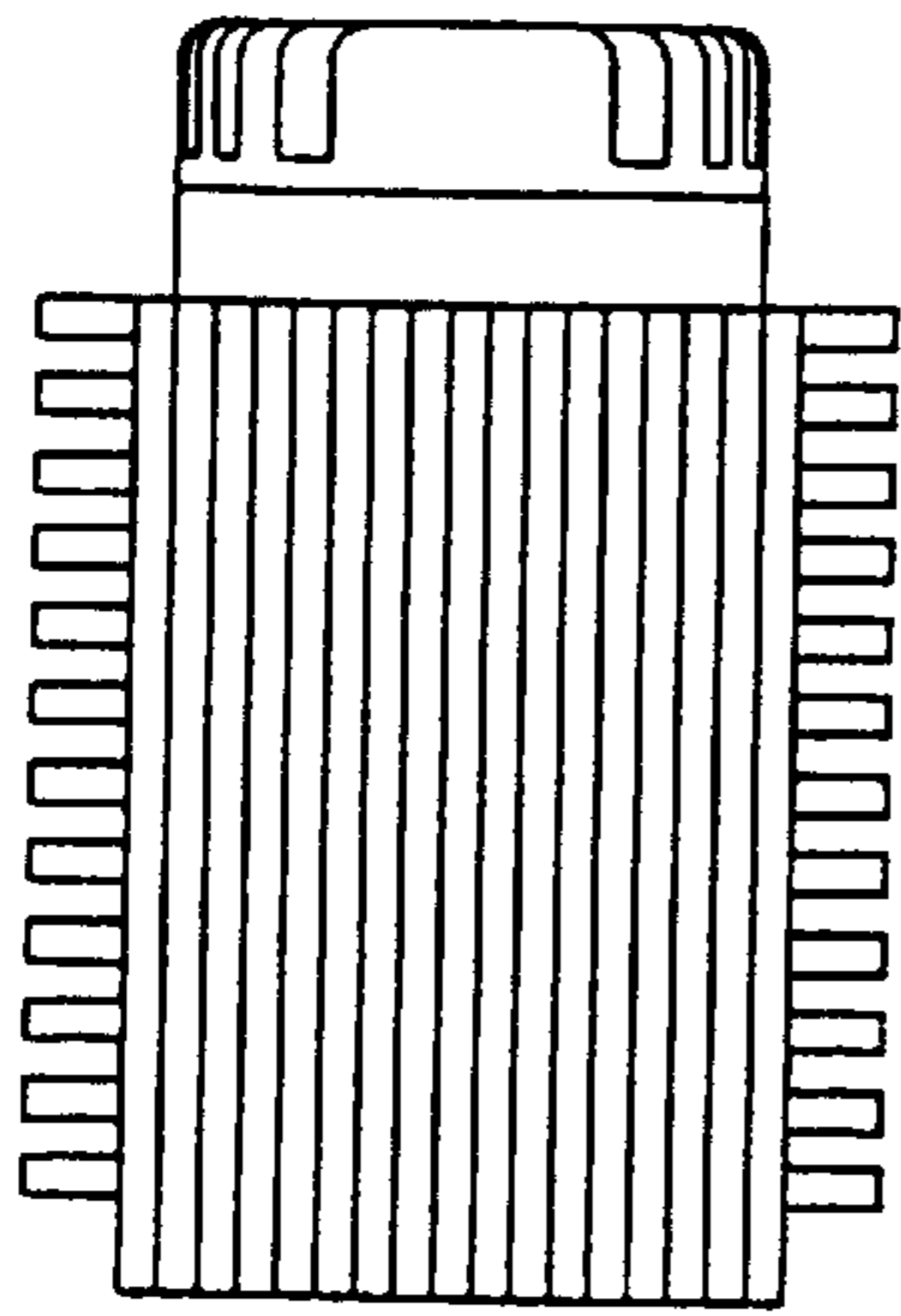

Fig. 1

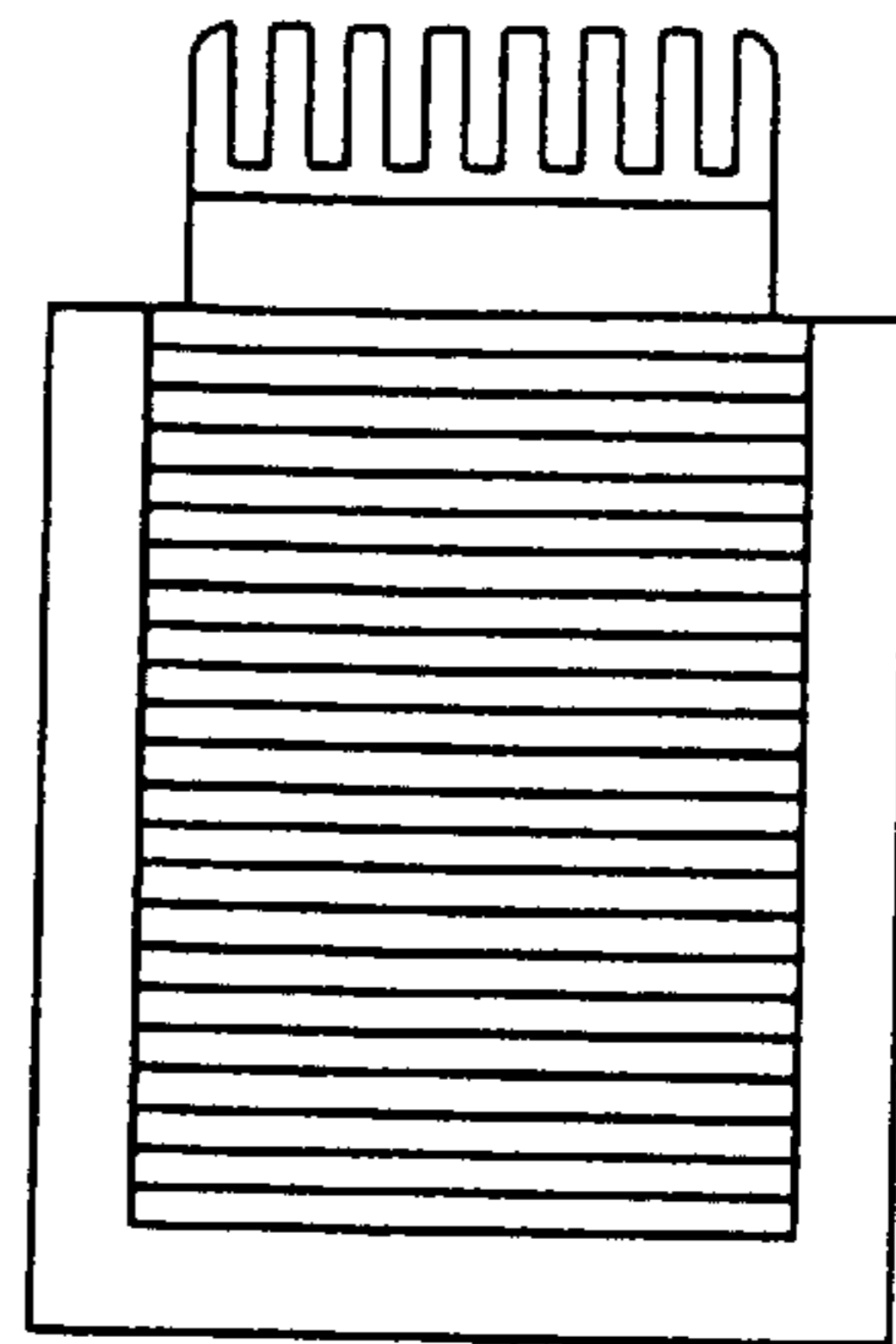

Fig. 2

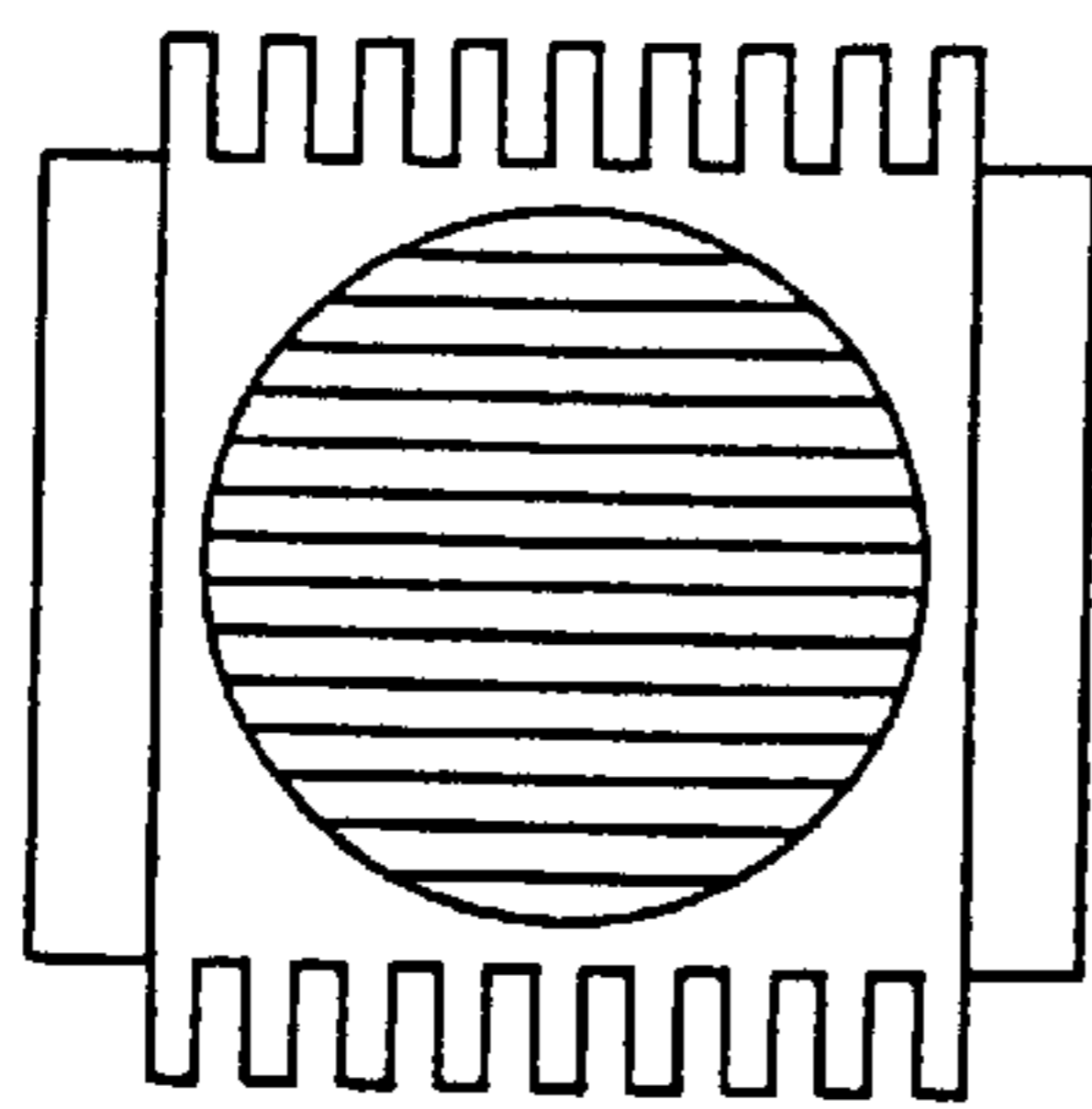

Fig. 3

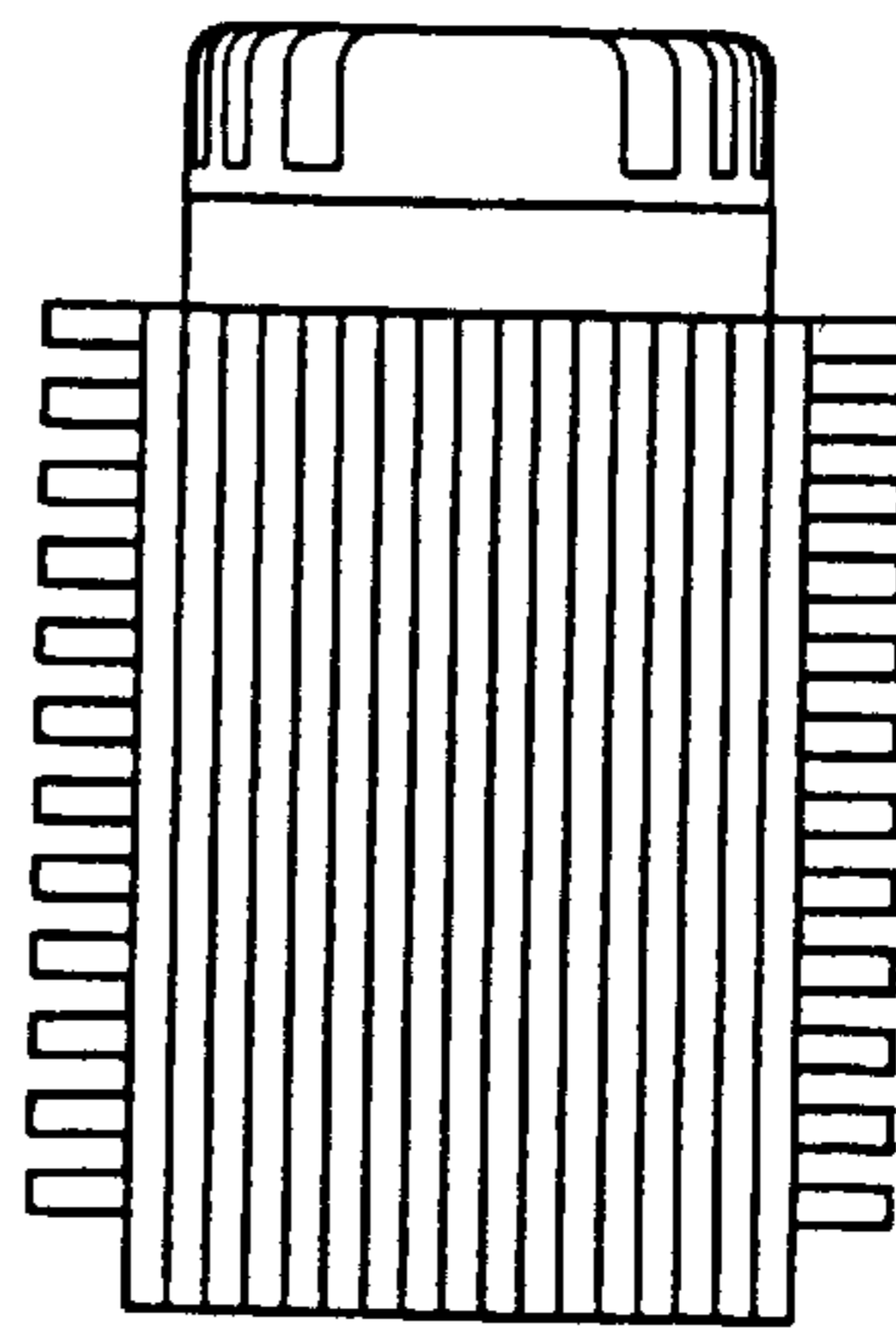

Fig. 5

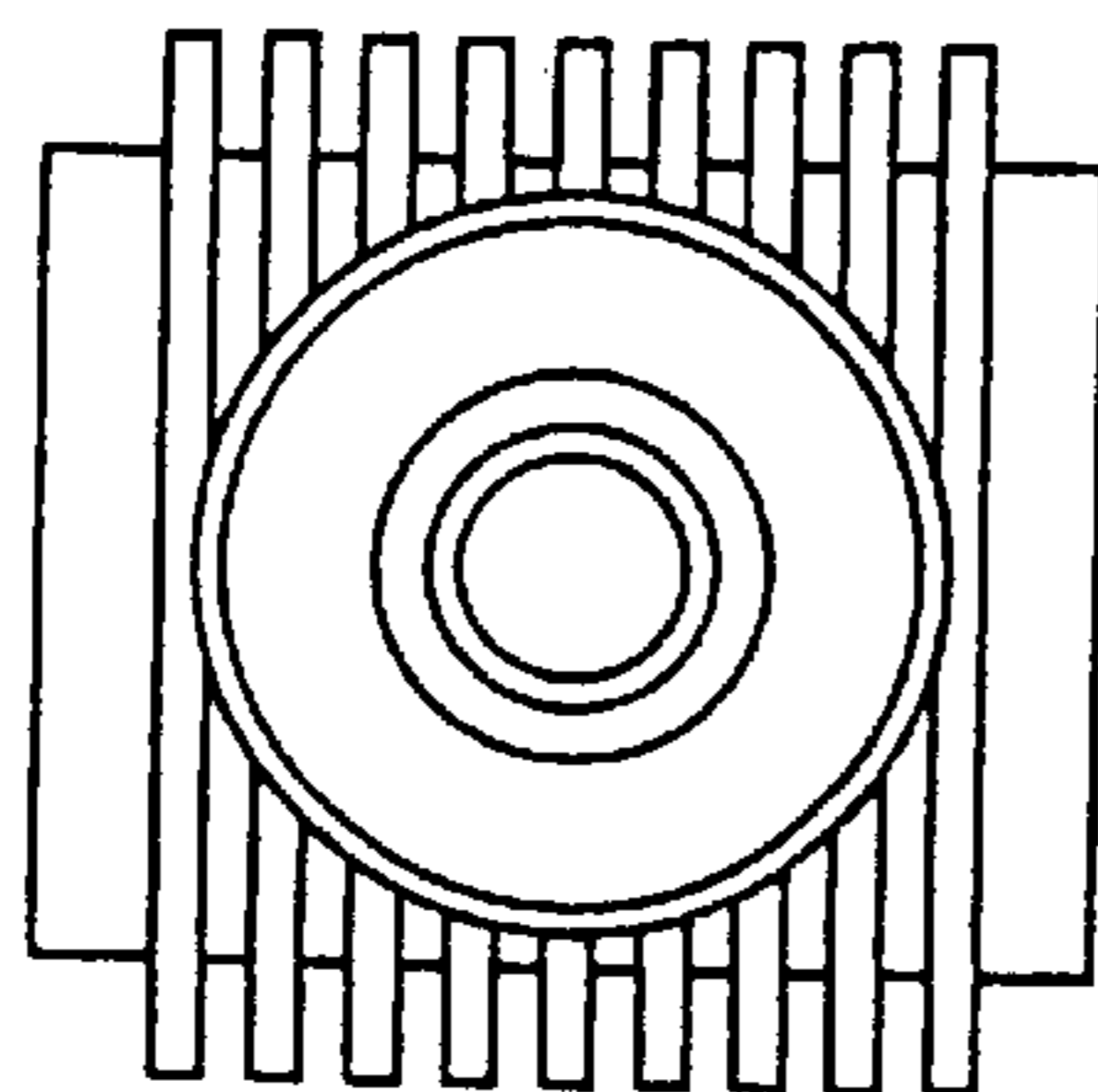

Fig. 4

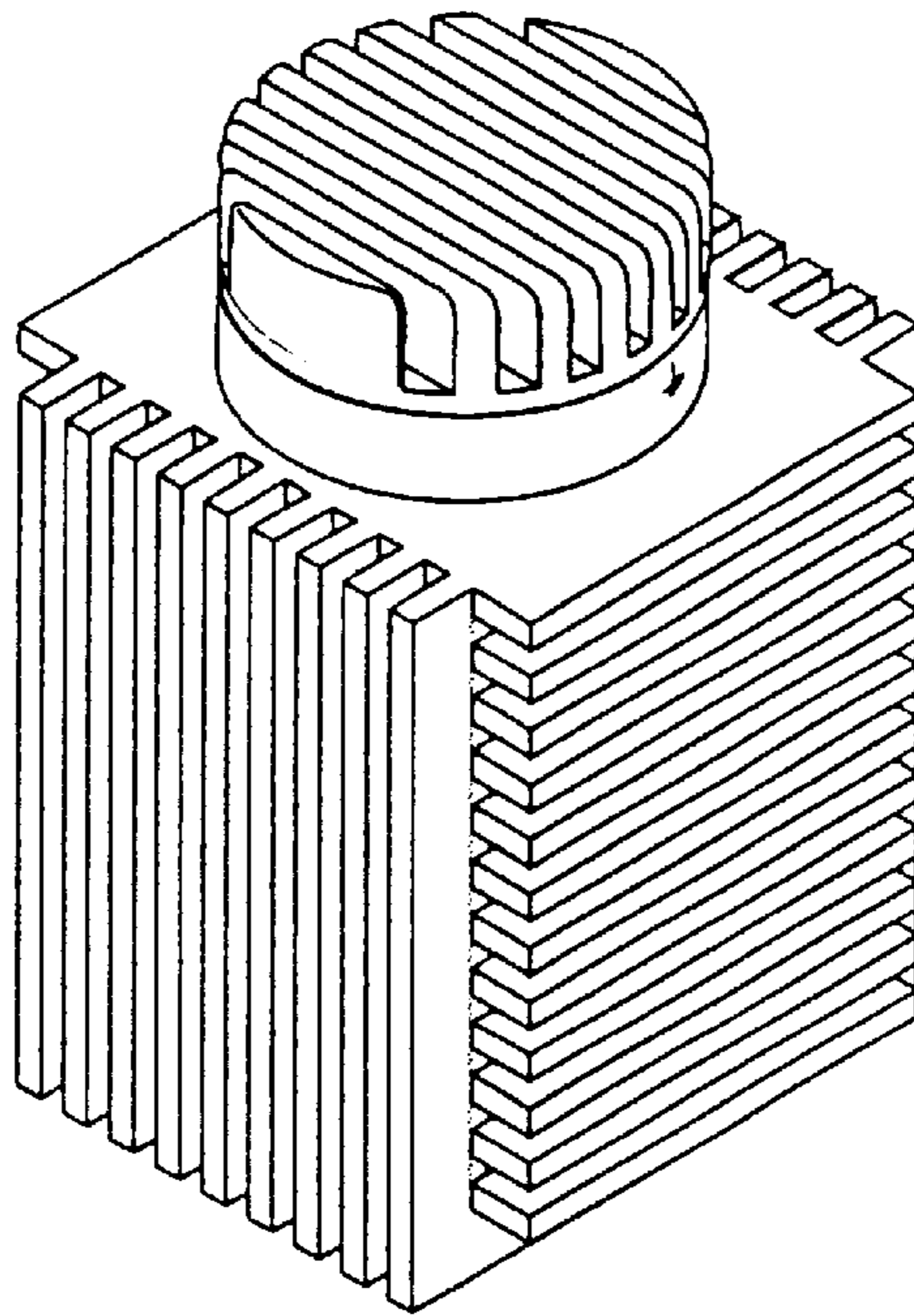

Fig. 6

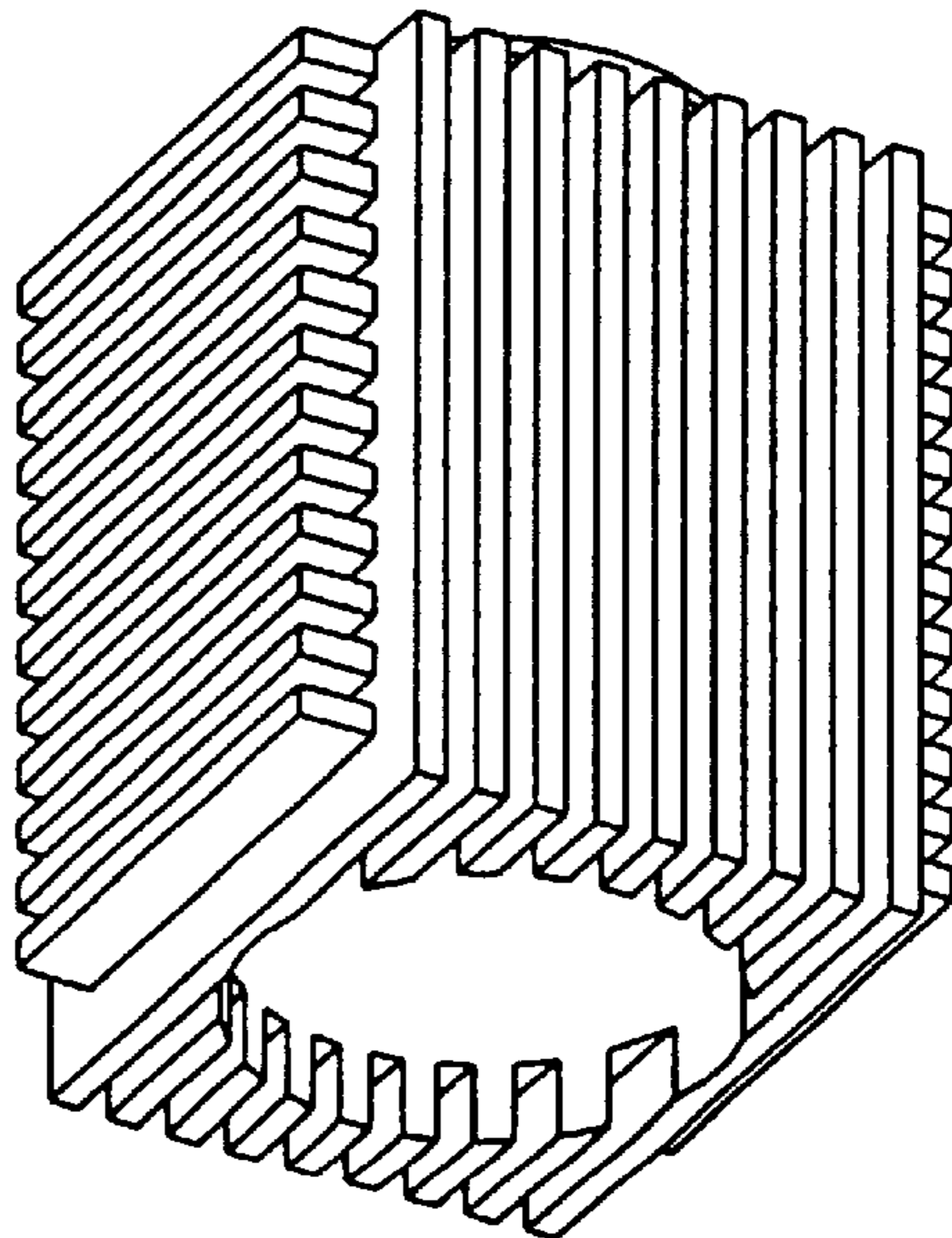

Fig. 7