



US00D45992S

(12) **United States Design Patent**
Olsen

(10) **Patent No.:** **US D459,992 S**

(45) **Date of Patent:** **** Jul. 9, 2002**

(54) **BEVERAGE CAN CAP**

(76) Inventor: **Bent Hjort Olsen**, Vølundsvej 16, 3400 Hillerød (DK)

(**) Term: **14 Years**

(21) Appl. No.: **29/148,502**

(22) Filed: **Sep. 20, 2001**

(51) **LOC (7) Cl.** **09-07**

(52) **U.S. Cl.** **D9/447**

(58) **Field of Search** D9/434, 435, 447;
220/711, 719

(56) **References Cited**

U.S. PATENT DOCUMENTS

D292,491 S	*	10/1987	Ross et al.	D9/447
4,961,510 A	*	10/1990	Dvoracek	220/713
D319,981 S	*	9/1991	Sledge	D9/447
D322,222 S	*	12/1991	Coy	D9/447
D325,170 S	*	4/1992	Frantz	D9/447
D326,816 S	*	6/1992	Abrams	D9/447

D329,981 S	*	10/1992	Card	D9/447
D368,032 S	*	3/1996	Couto	D9/435
D435,445 S	*	12/2000	Bragoni	D9/447

* cited by examiner

Primary Examiner—Dominic Simone

(57) **CLAIM**

I claim the ornamental design for the beverage can cap, as shown and described.

DESCRIPTION

FIG. 1 is a bottom view of the new ornamental beverage can cap of the present invention.
 FIG. 2 is a top perspective view thereof.
 FIG. 3 is a left side view thereof.
 FIG. 4 is a rear view thereof.
 FIG. 5 is a right side view thereof.
 FIG. 6 is a top view thereof.
 FIG. 7 is a front view thereof; and,
 FIG. 8 is a bottom perspective view thereof.

1 Claim, 2 Drawing Sheets

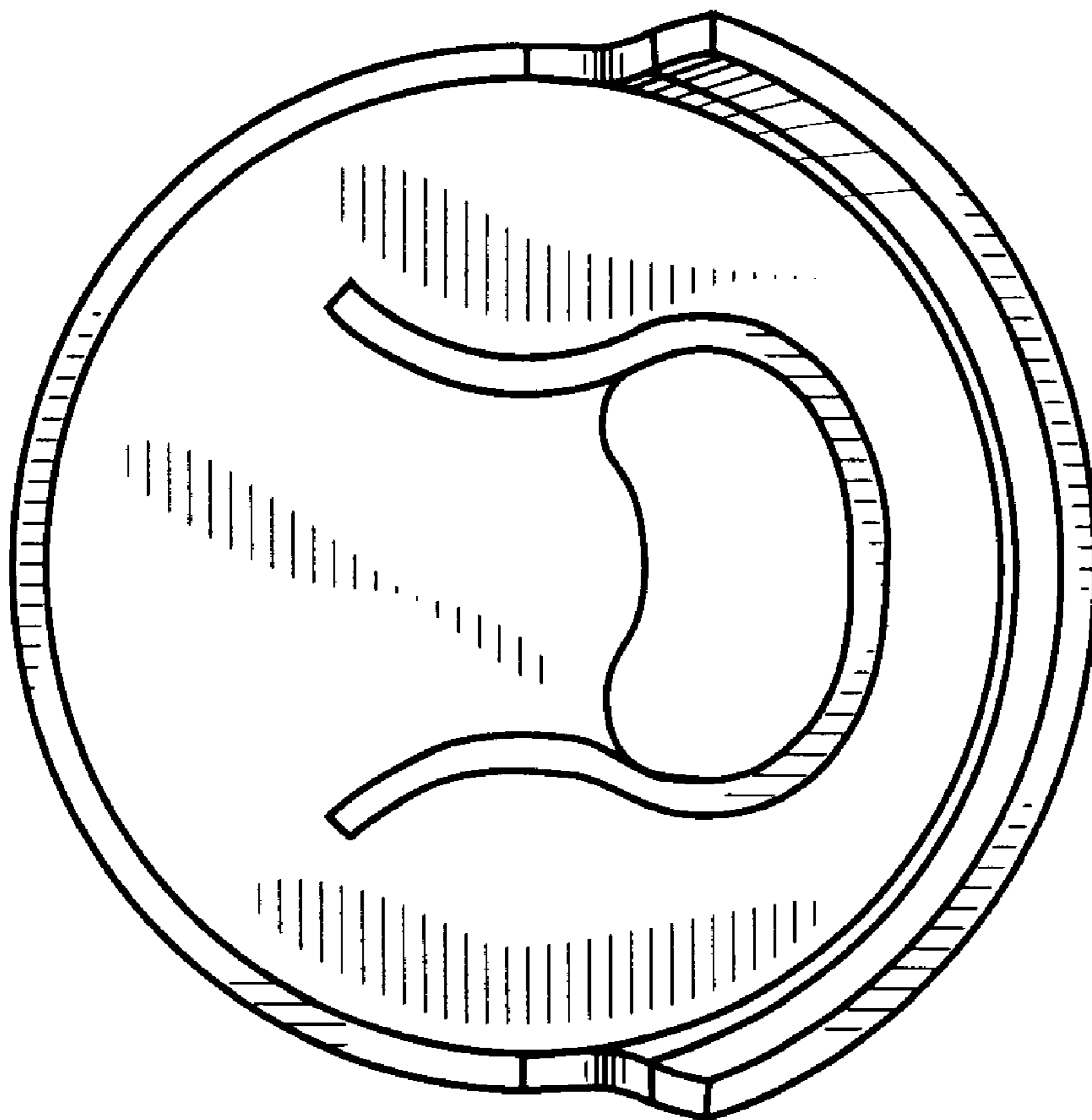

FIG. 1

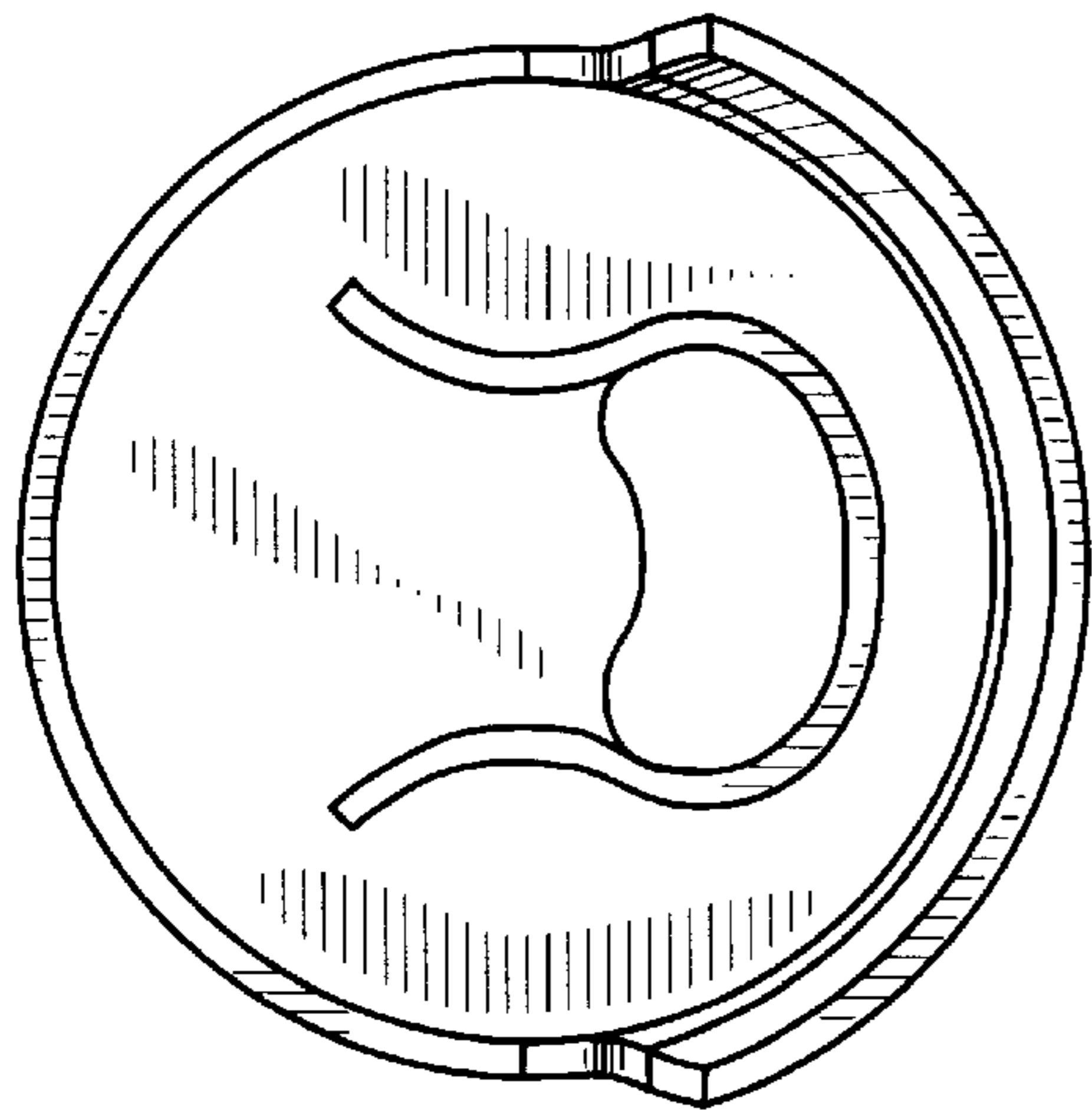

FIG. 2

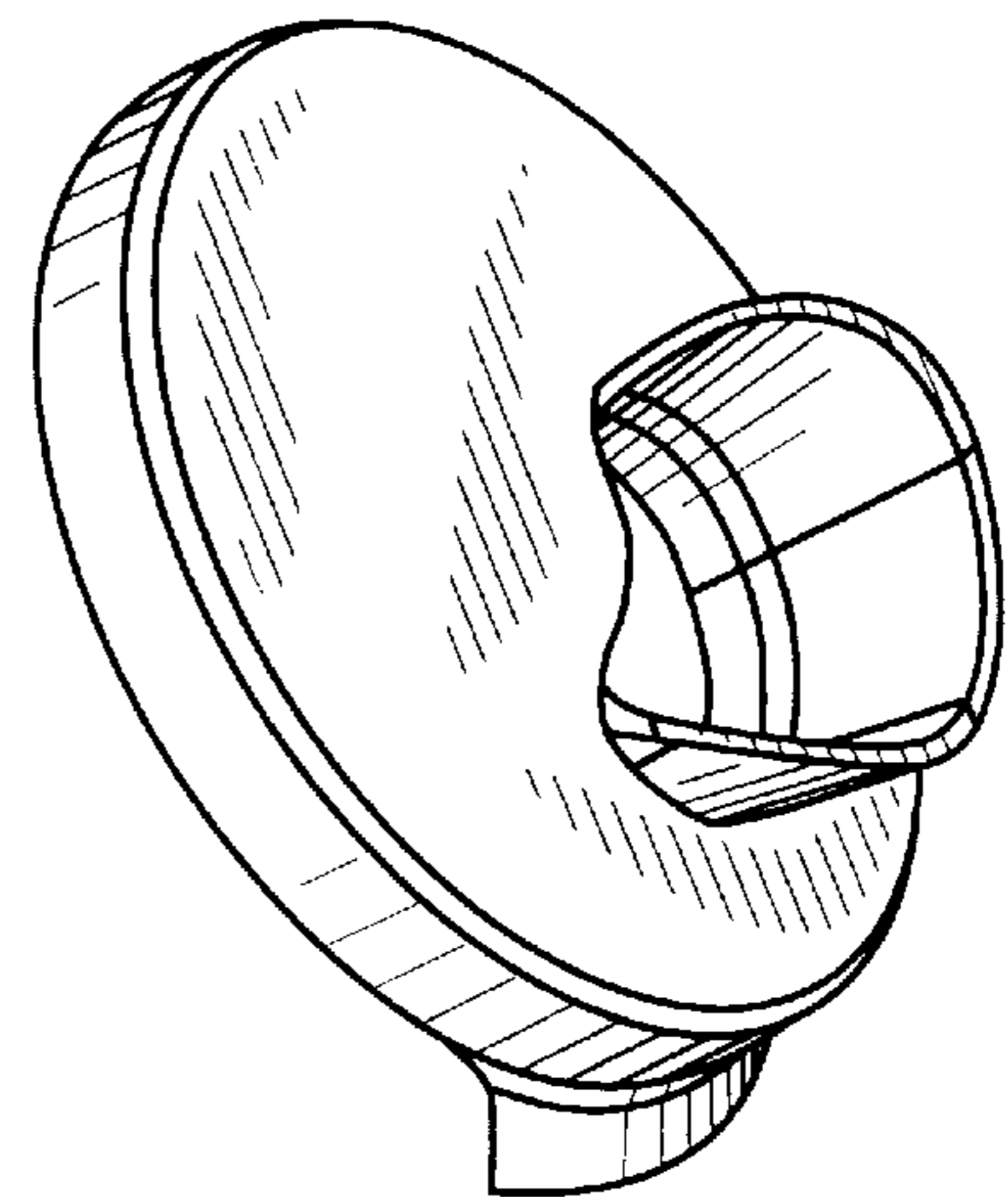

FIG. 3

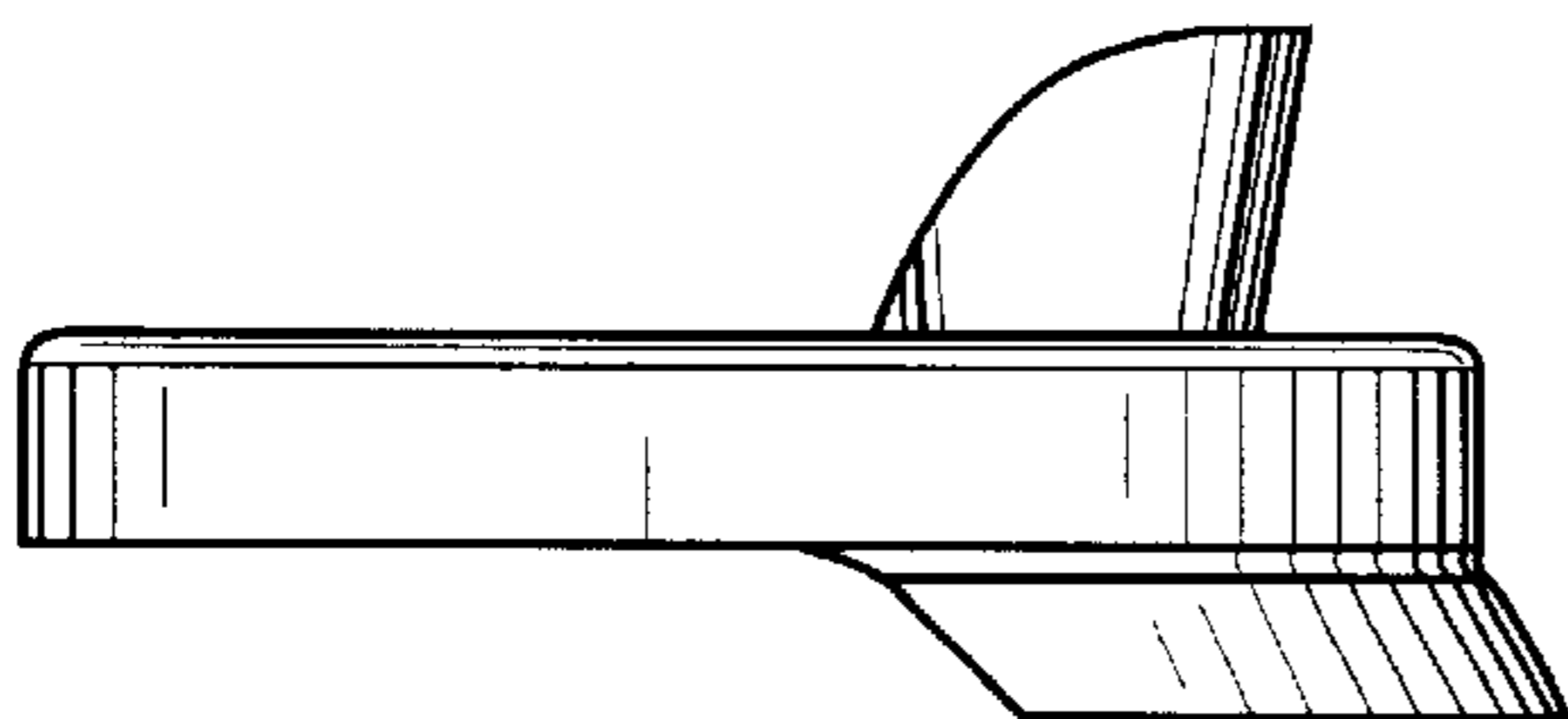

FIG. 4

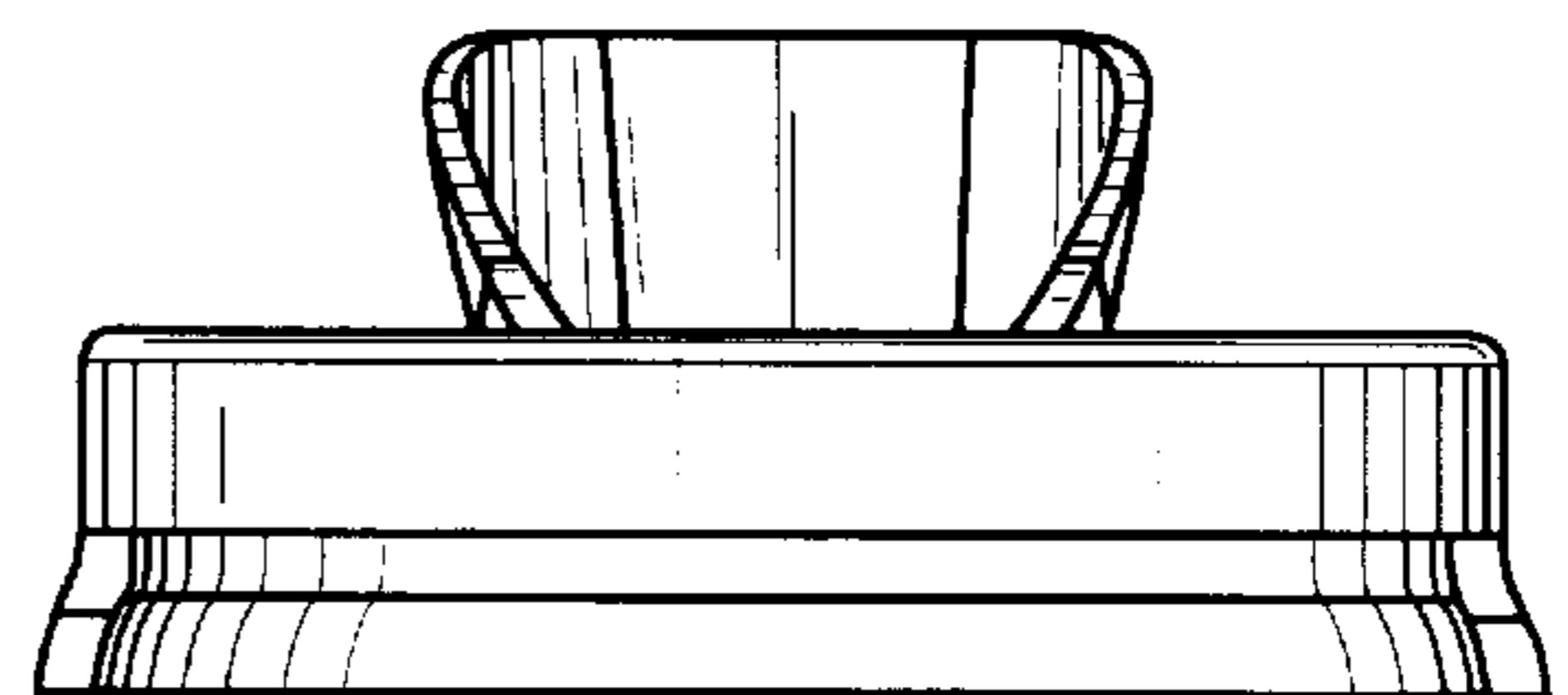

FIG. 5

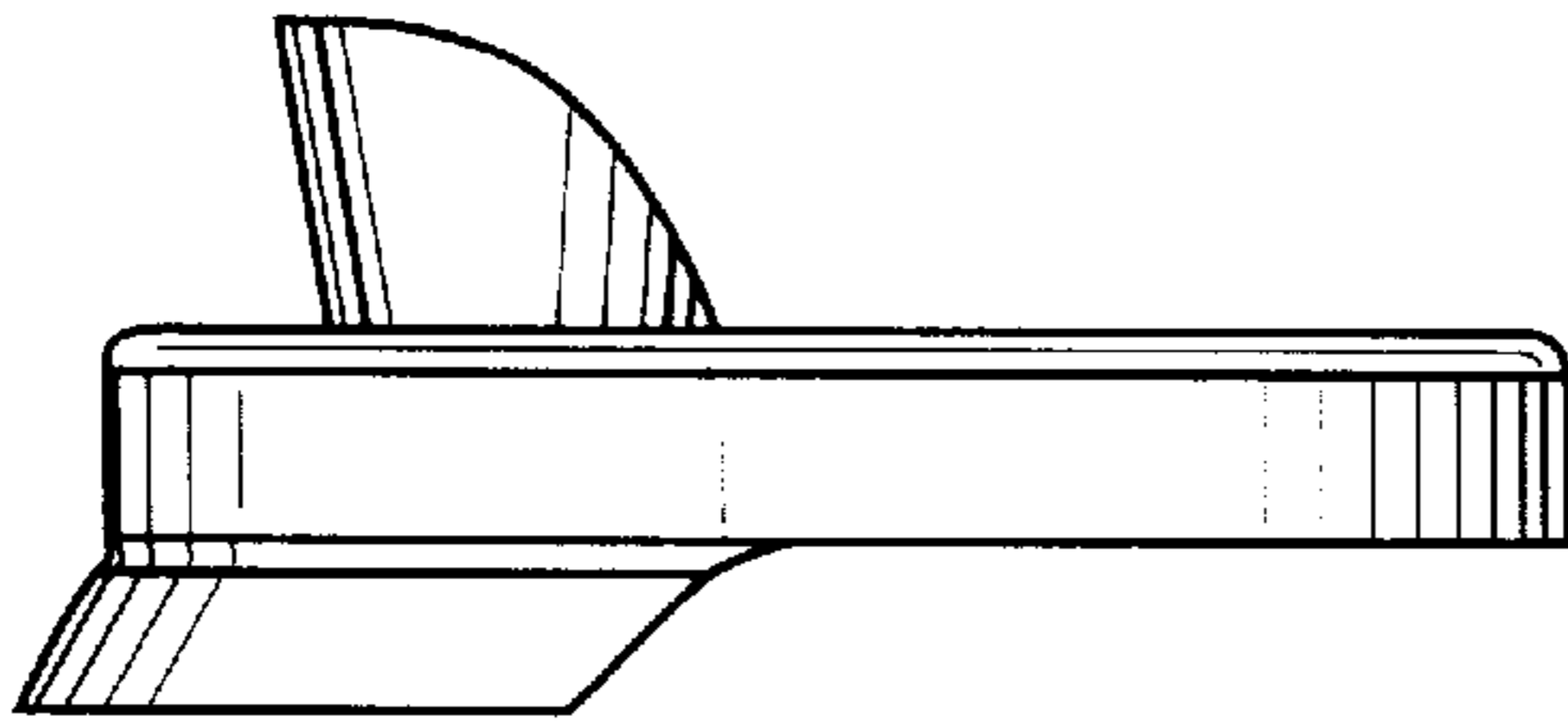

FIG. 6

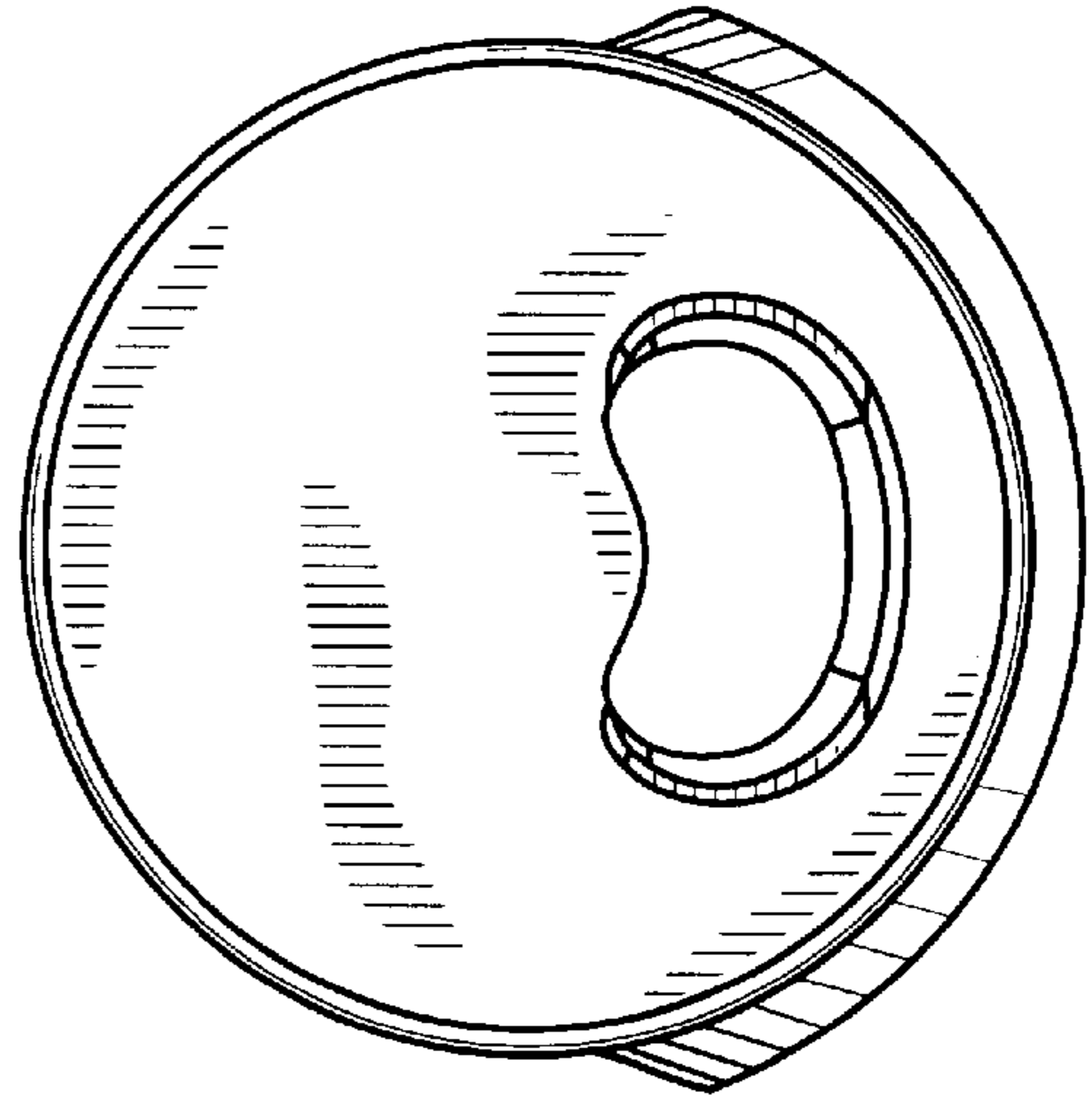

FIG. 7

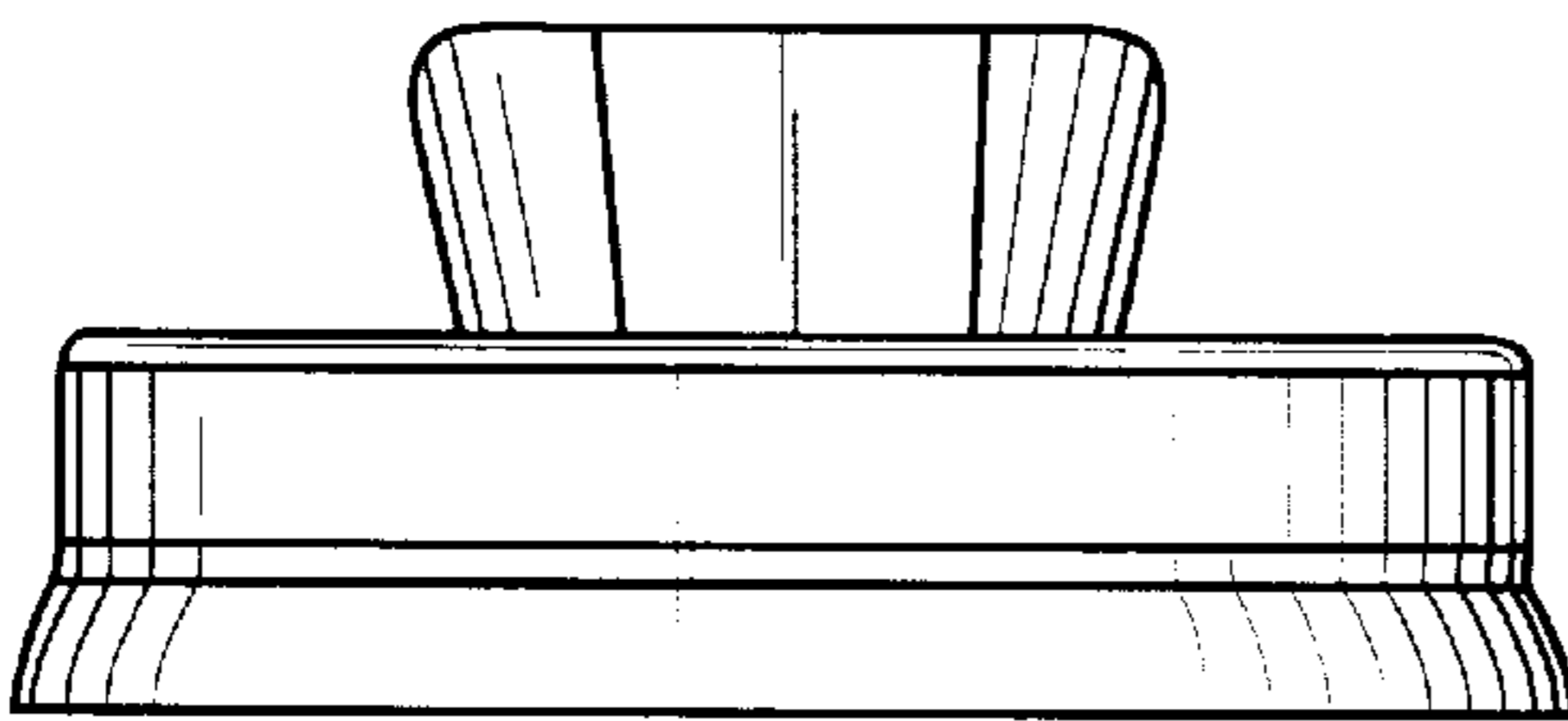

FIG. 8

