



US00D459982S

(12) **United States Design Patent**
Vande Steeg et al.

(10) **Patent No.:** **US D459,982 S**

(45) **Date of Patent:** **** Jul. 9, 2002**

(54) **COMBINED FOLDING CRANK HANDLE AND COVER ASSEMBLY FOR A CASEMENT WINDOW OPERATOR**

(75) **Inventors:** **David J. Vande Steeg**, Pella; **Andrew W. Middleswart**, Indianola; **Marlo G. Van Klompenburg**; **Bruce A. Baier**, both of Pella, all of IA (US); **Frank R. Wilgus**, Delaware, OH (US); **Gregory J. Vetter**, Owatonna, MN (US)

(73) **Assignee:** **Pella Corporation**, Pella, IA (US)

(**) **Term:** **14 Years**

(21) **Appl. No.:** **29/151,542**

(22) **Filed:** **Nov. 13, 2001**

Related U.S. Application Data

(63) Continuation of application No. 29/133,777, filed on Dec. 6, 2000, now Pat. No. Des. 450,237.

(51) **LOC (7) Cl.** **08-09**

(52) **U.S. Cl.** **D8/400**

(58) **Field of Search** D8/338, 400, 337, D8/344, 322; 292/336.3, 198, 200, 202, 210, DIG. 33, DIG. 31, DIG. 20; 70/209, 208

(56) **References Cited**

U.S. PATENT DOCUMENTS

5,620,213 A *	4/1997	Ellis	292/210
D421,209 S *	2/2000	Buckland	D8/338
6,039,363 A *	3/2000	Sugimura et al.	292/202
6,227,581 B1 *	5/2001	Lambert	292/200

* cited by examiner

Primary Examiner—Brian N. Vinson

(74) *Attorney, Agent, or Firm*—Faegre & Benson, LLP

(57) **CLAIM**

The ornamental design for a combined folding crank handle and cover assembly for a casement window operator, as shown and described.

DESCRIPTION

FIG. 1 is a top front perspective view of a combined folding crank handle and cover assembly embodying our design in accordance with the present invention;

FIG. 2 is a top plan view thereof;

FIG. 3 is a side elevational view thereof;

FIG. 4 is an opposite side elevational view thereof;

FIG. 5 is an end elevational view thereof; and,

FIG. 6 is an opposite end elevational view thereof.

The broken lines are for illustrative purposes only and form no part of the claimed design.

1 Claim, 1 Drawing Sheet

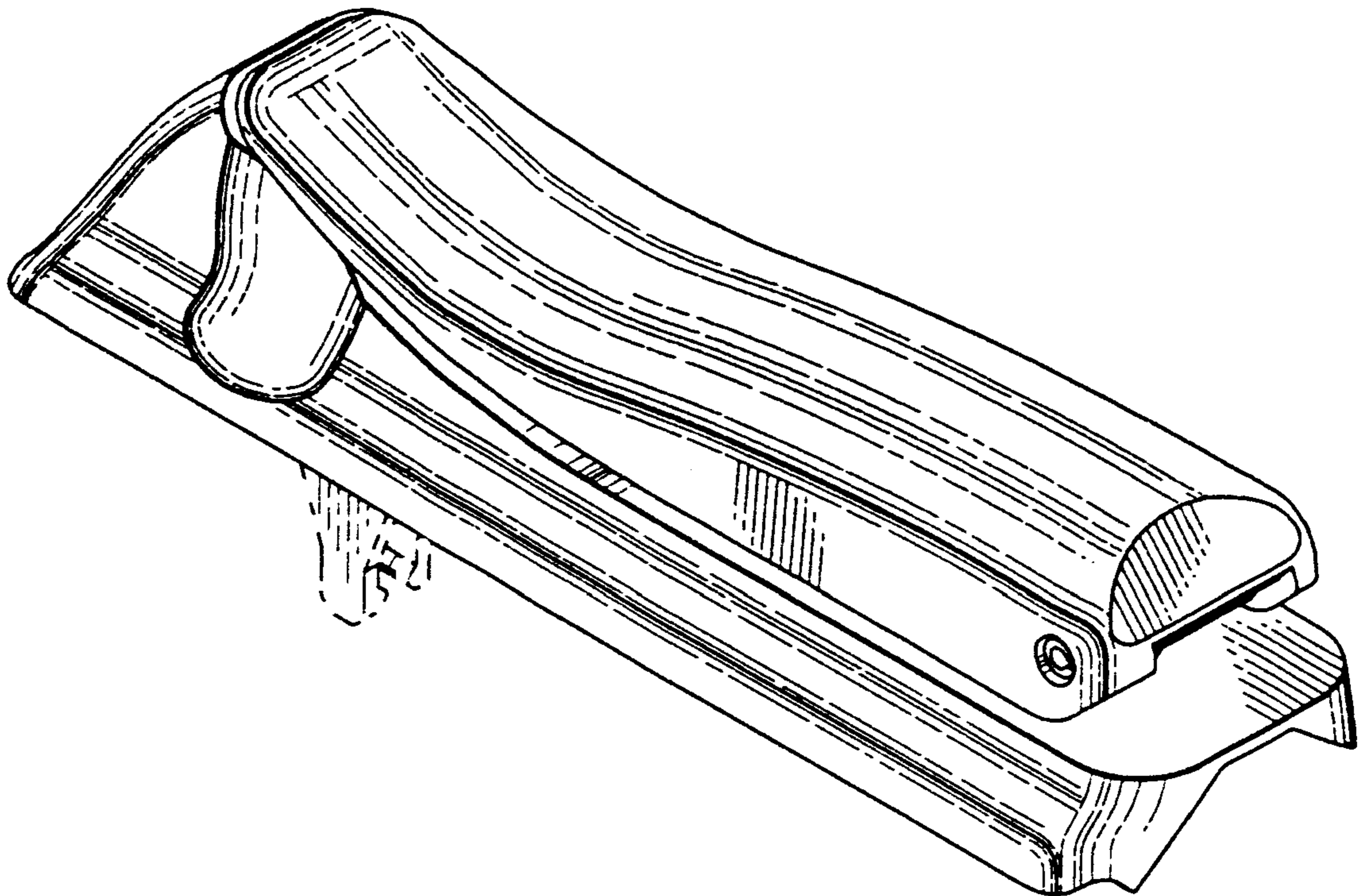

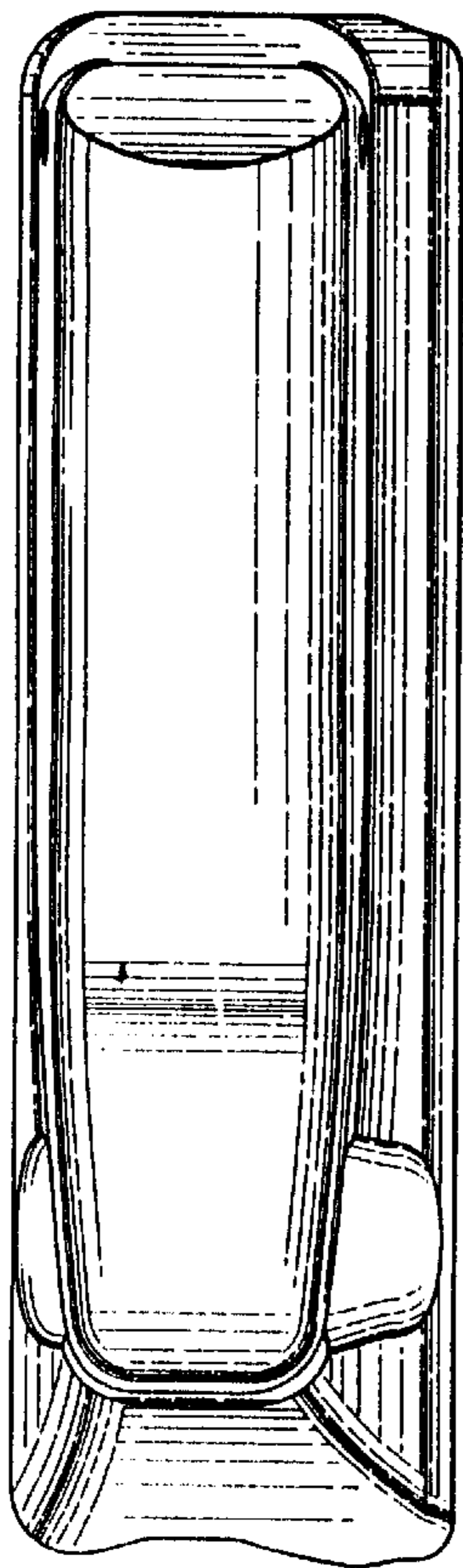

Fig. 2.

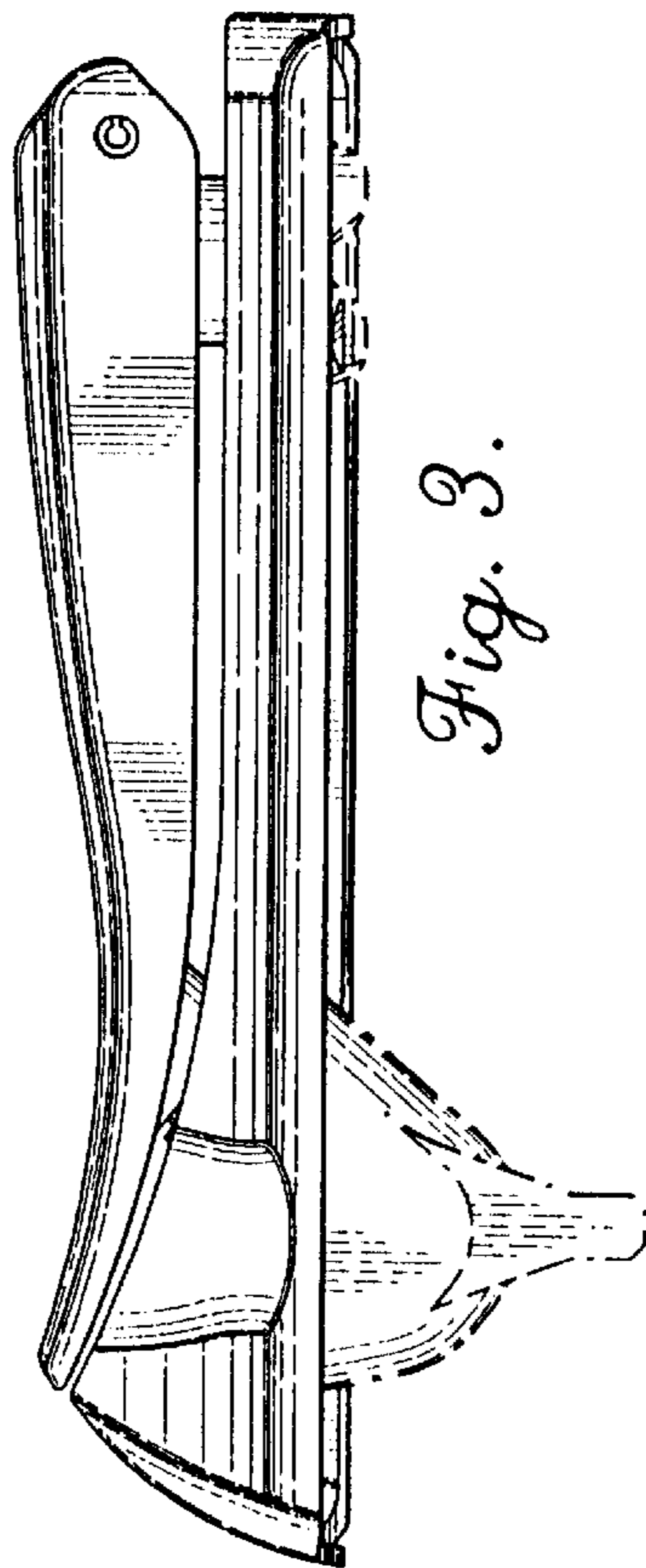

Fig. 3.

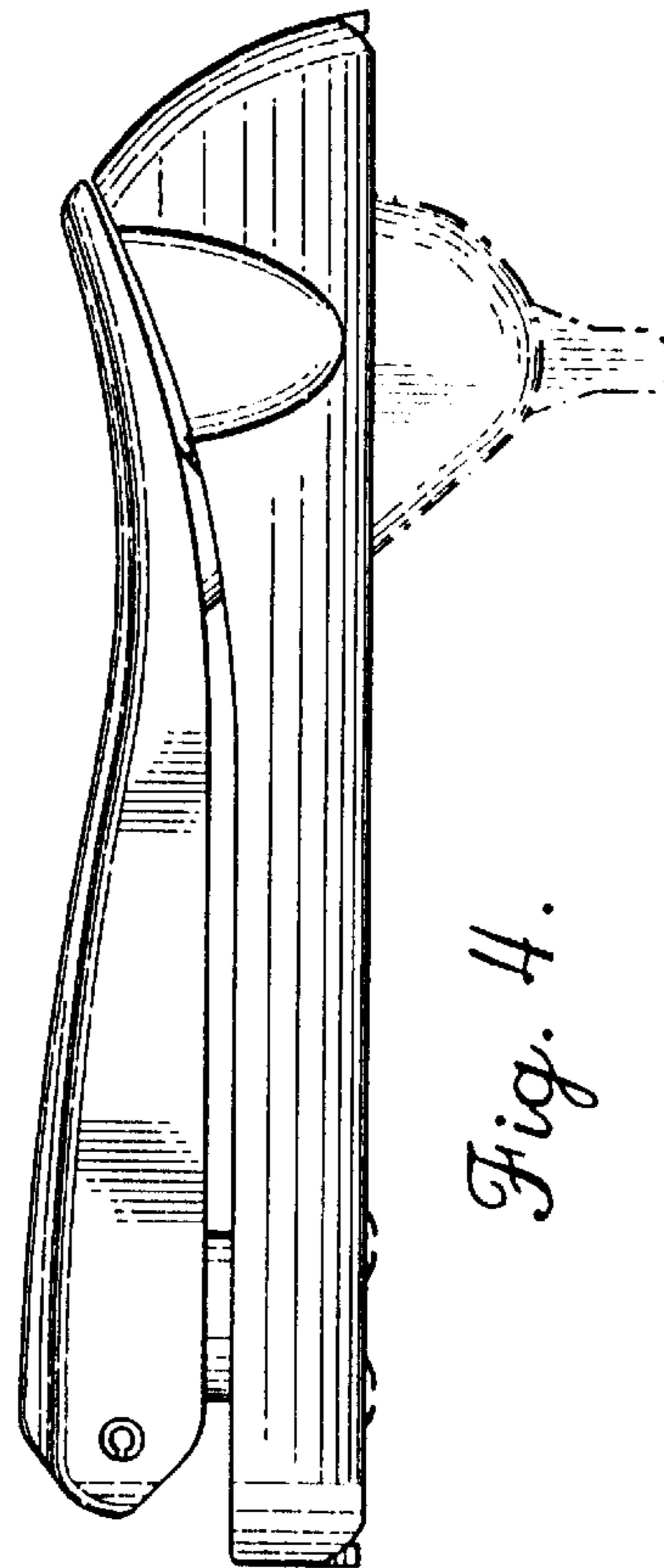

Fig. 4.

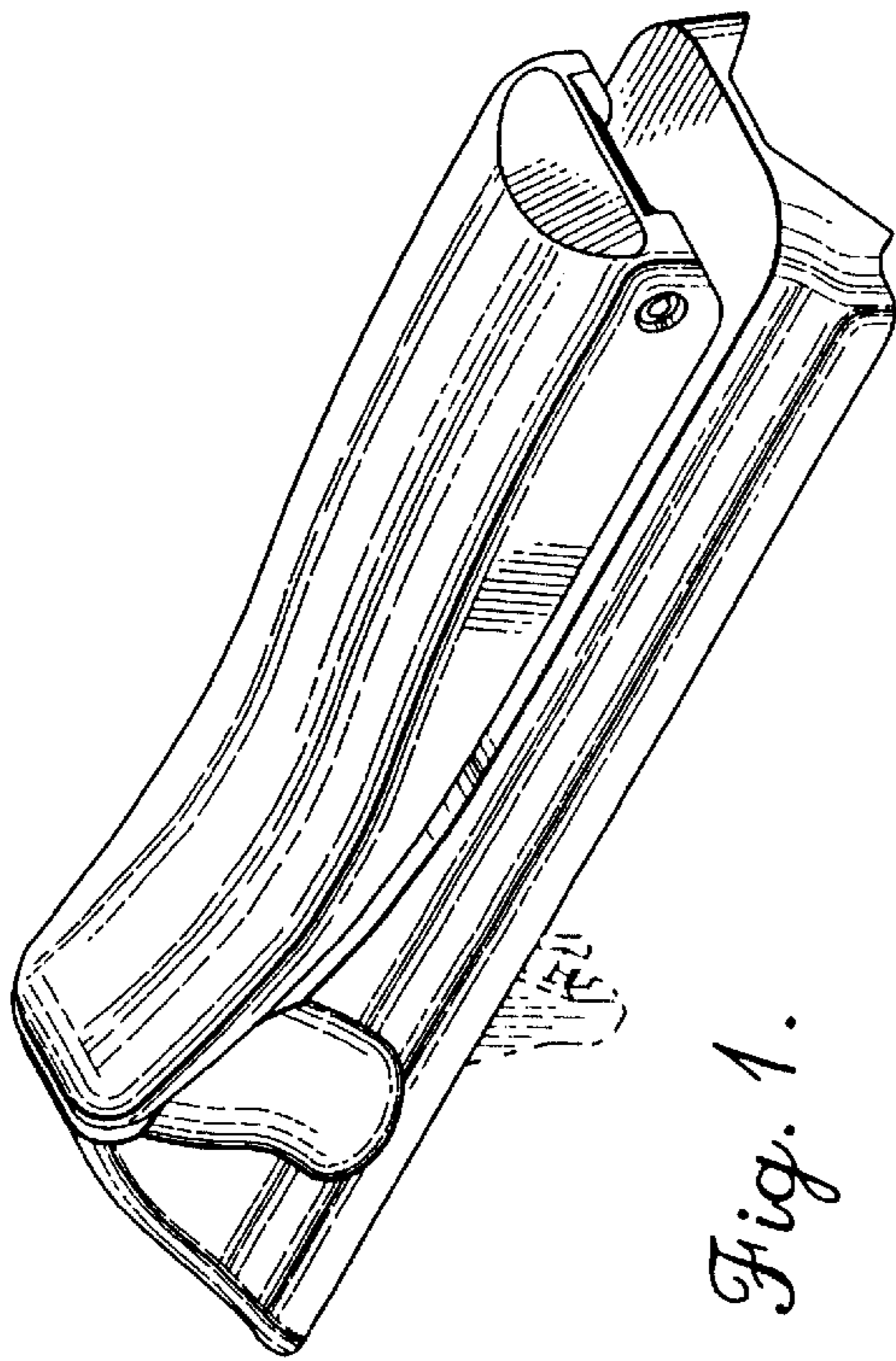

Fig. 1.

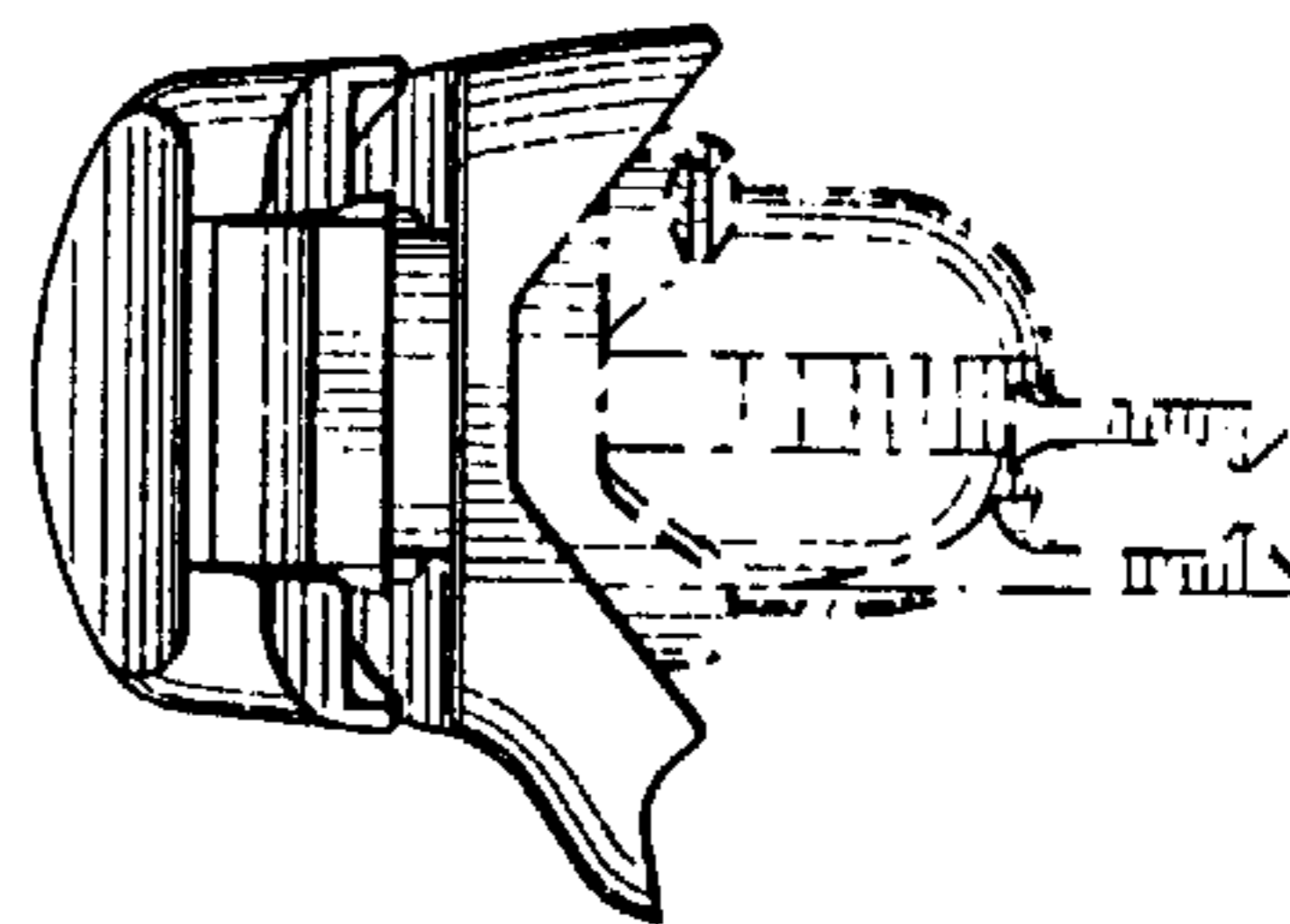

Fig. 6.

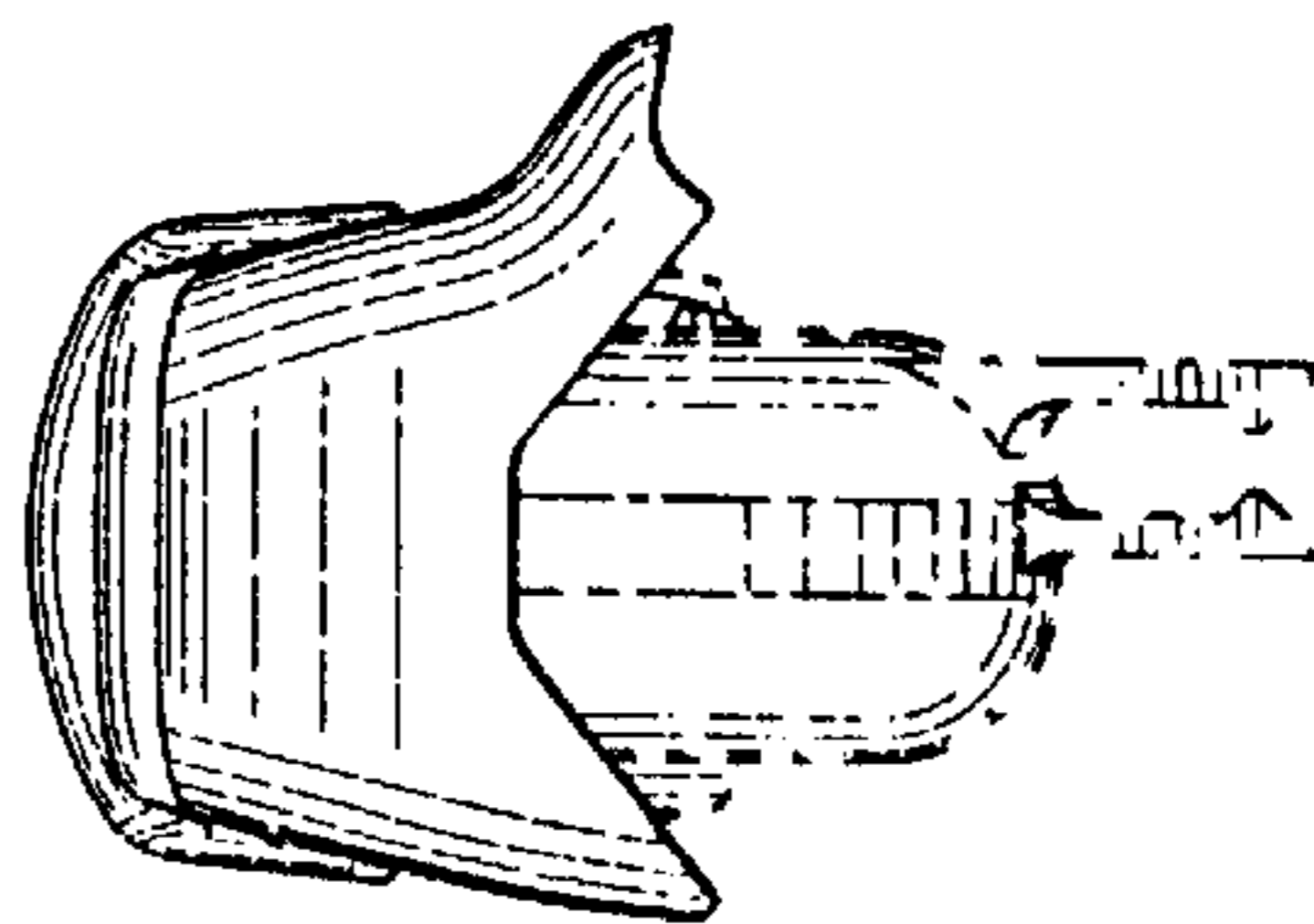

Fig. 5.