



US00D459971S

(12) **United States Design Patent**
Quan et al.

(10) **Patent No.:** **US D459,971 S**

(45) **Date of Patent:** **** Jul. 9, 2002**

(54) **DIAL FOR A LOCK**

D276,408 S * 11/1984 Zabel et al. D8/334
D418,392 S * 1/2000 Kelley D8/334

(75) Inventors: **Jon F. Quan**, Fountain Valley; **Robert L. Gast**, Irvine, both of CA (US)

* cited by examiner

(73) Assignee: **Hampton Products International**,
Foothill Ranch, CA (US)

Primary Examiner—Brian N. Vinson

Assistant Examiner—B. Phoenix

(74) *Attorney, Agent, or Firm*—William G. Lane

(**) Term: **14 Years**

(57) **CLAIM**

(21) Appl. No.: **29/132,239**

The ornamental design for a dial for a lock, as shown and described.

(22) Filed: **Nov. 6, 2000**

DESCRIPTION

(51) **LOC (7) Cl.** **08-07**

(52) **U.S. Cl.** **D8/343; D8/334**

(58) **Field of Search** D8/334, 343; 70/20,
70/22, 51

FIG. 1 is a top, front, and left side perspective view of a dial for a lock showing our new design;

FIG. 2 is a right side elevational view thereof;

FIG. 3 is a front elevational view thereof;

FIG. 4 is an enlarged fragmentary front elevational view thereof; and,

FIG. 5 is a fragmentary left side elevational view thereof.

The broken-line disclosure in the views is for illustrative purposes only and forms no part of the claimed design.

(56) **References Cited**

U.S. PATENT DOCUMENTS

2,690,664	A	*	10/1954	Miller	70/21
D205,005	S	*	6/1966	Harrell	70/21 X
D251,965	S	*	5/1979	Uyeda	D8/343
4,462,231	A	*	7/1984	Zabel	70/21

1 Claim, 2 Drawing Sheets

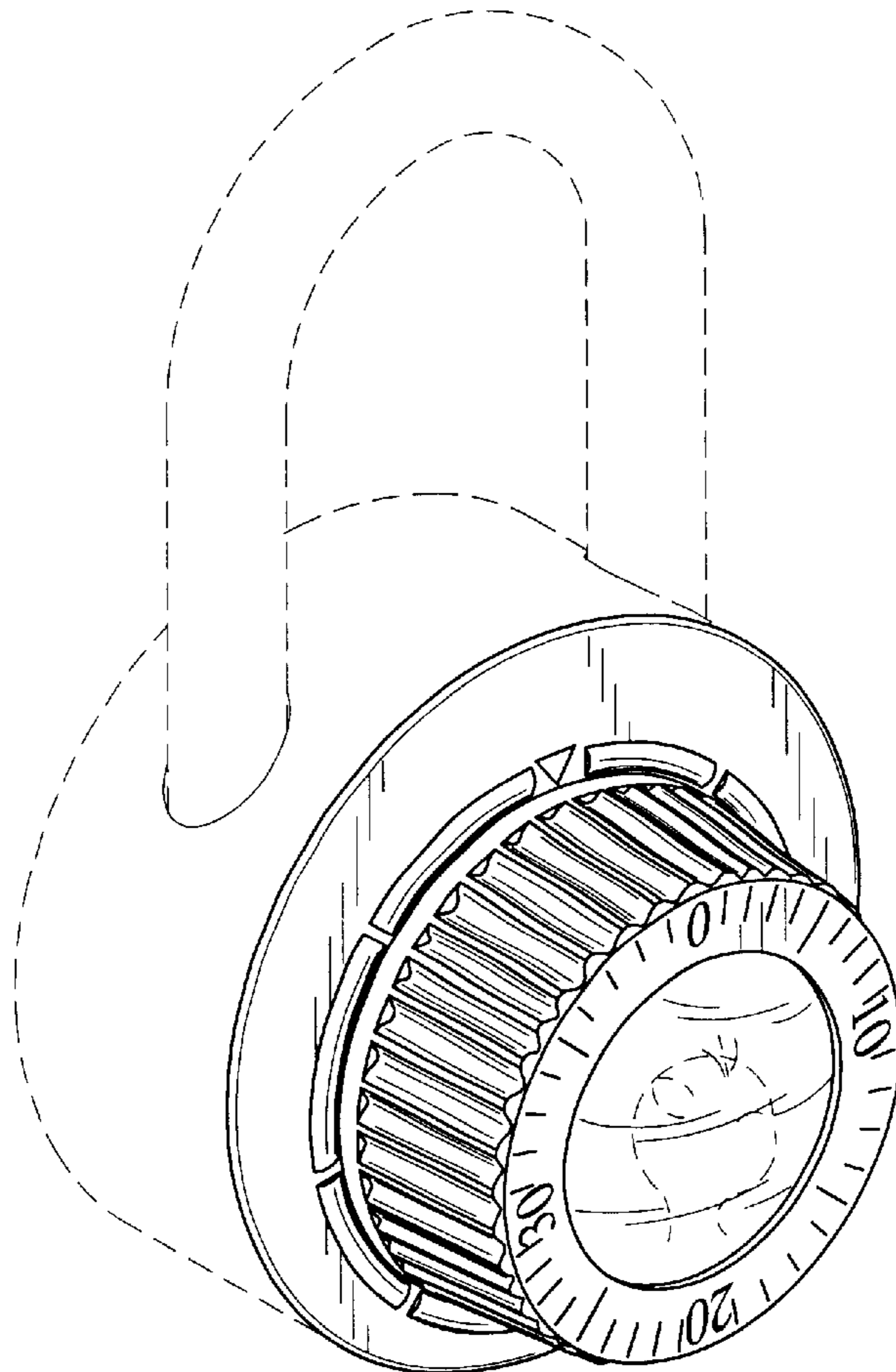

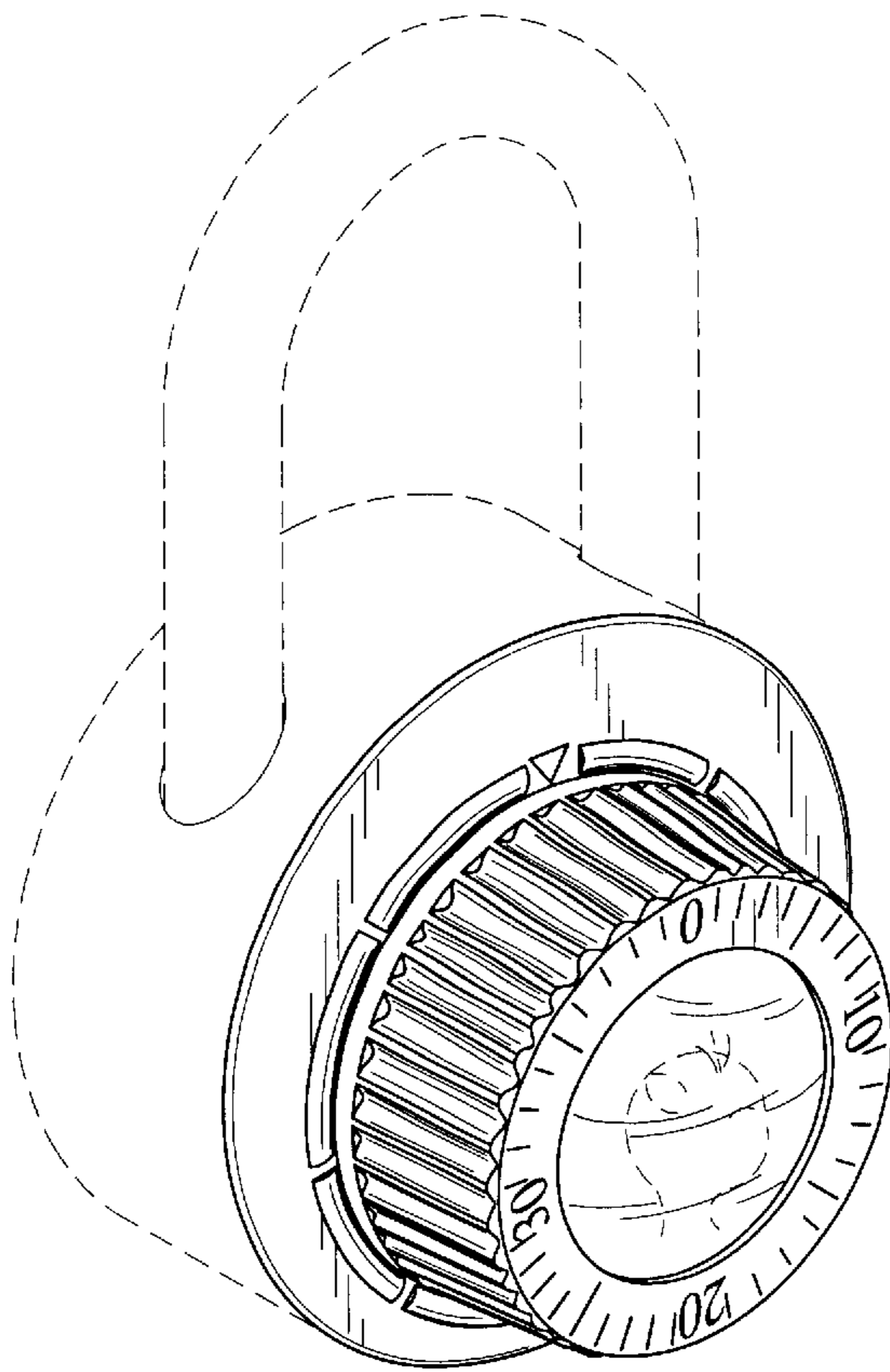

FIG. 1

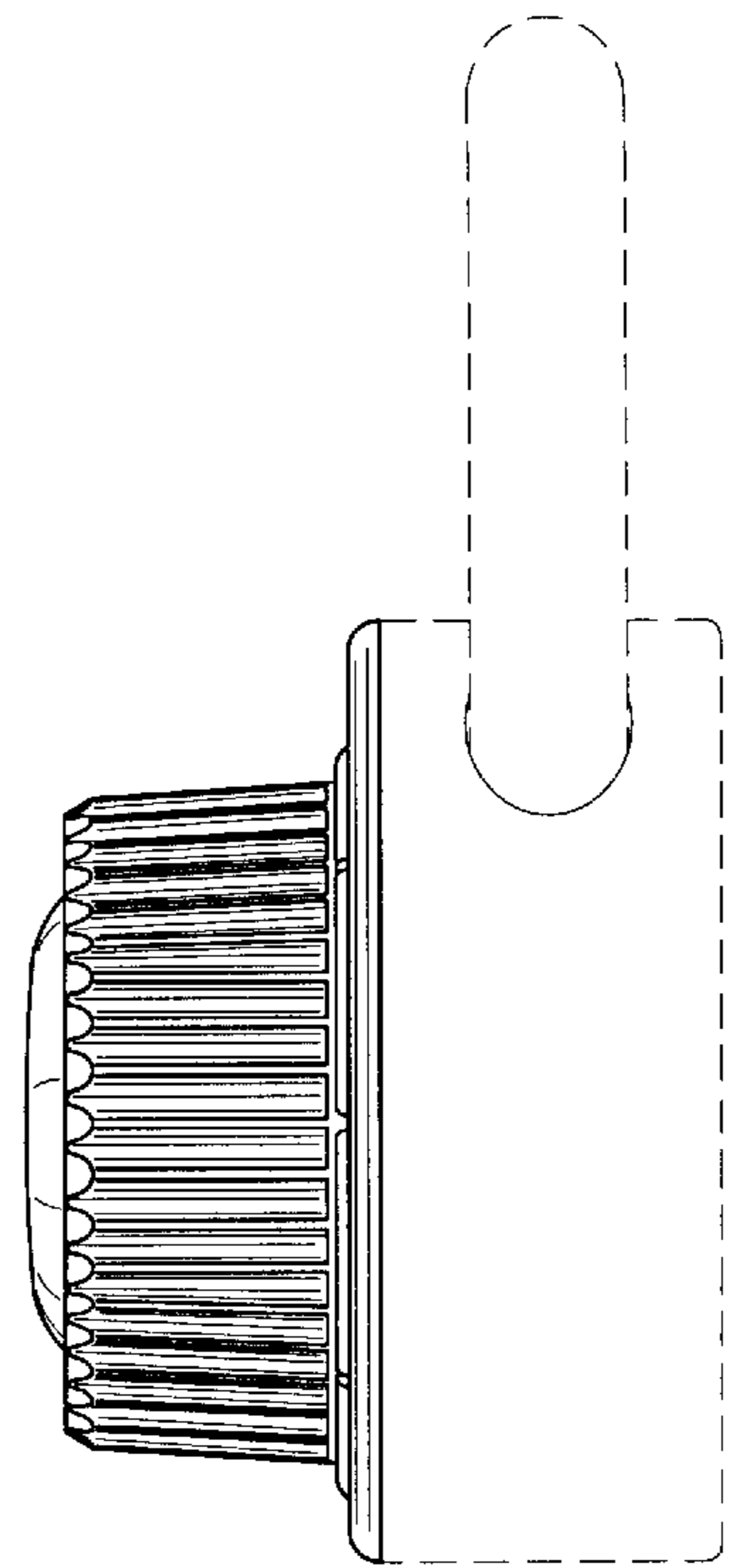

FIG. 2

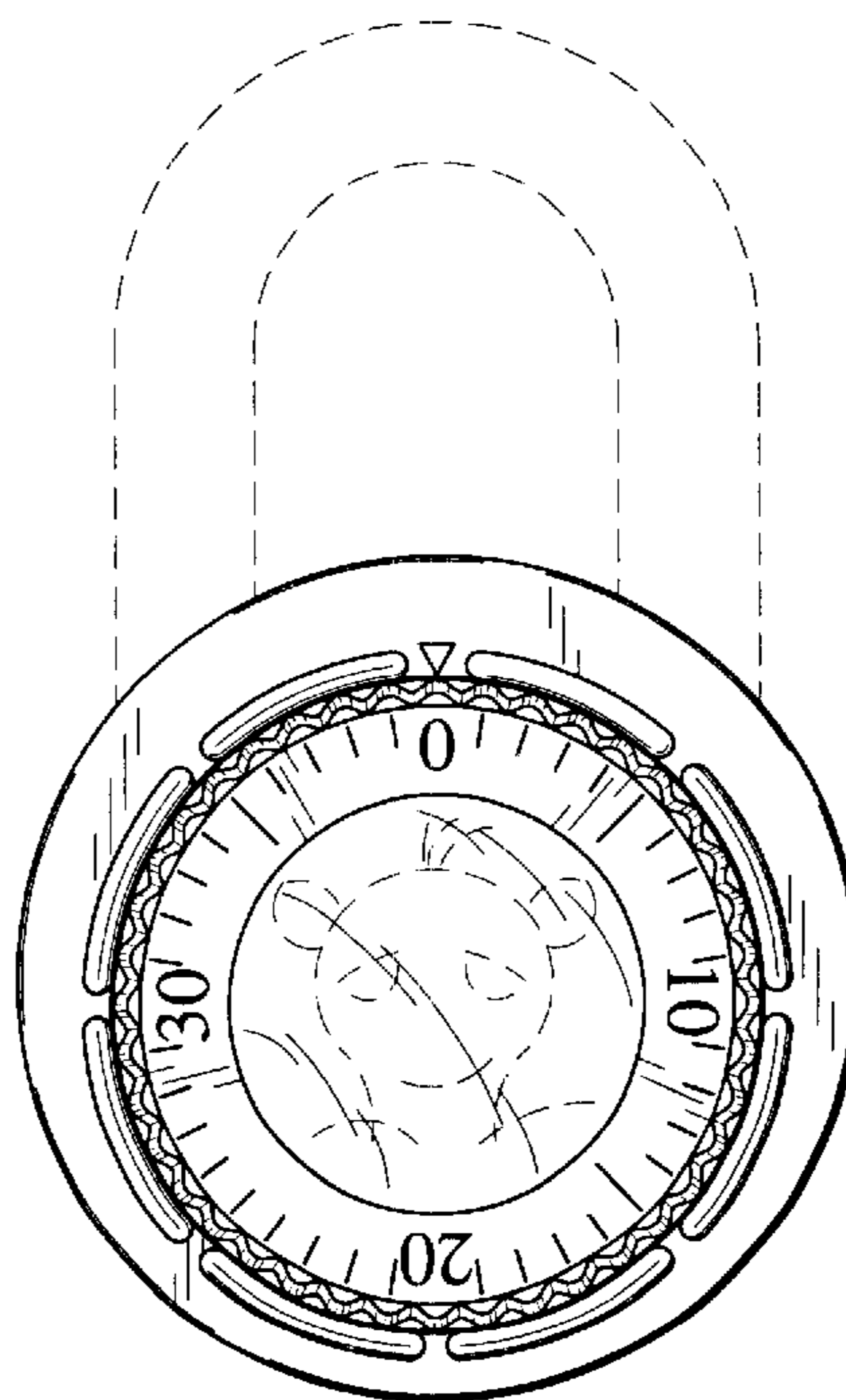

FIG. 3

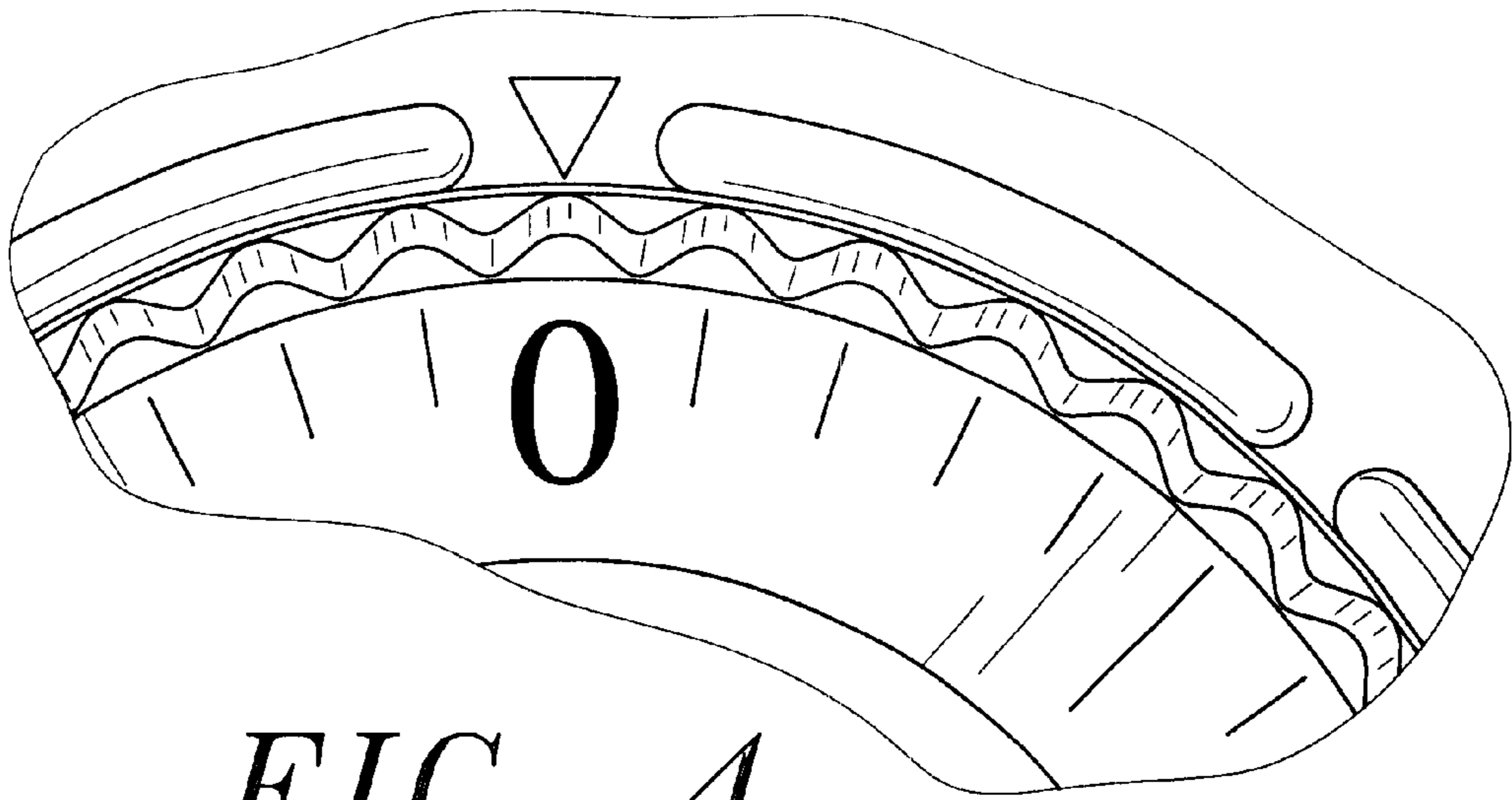

FIG. 4

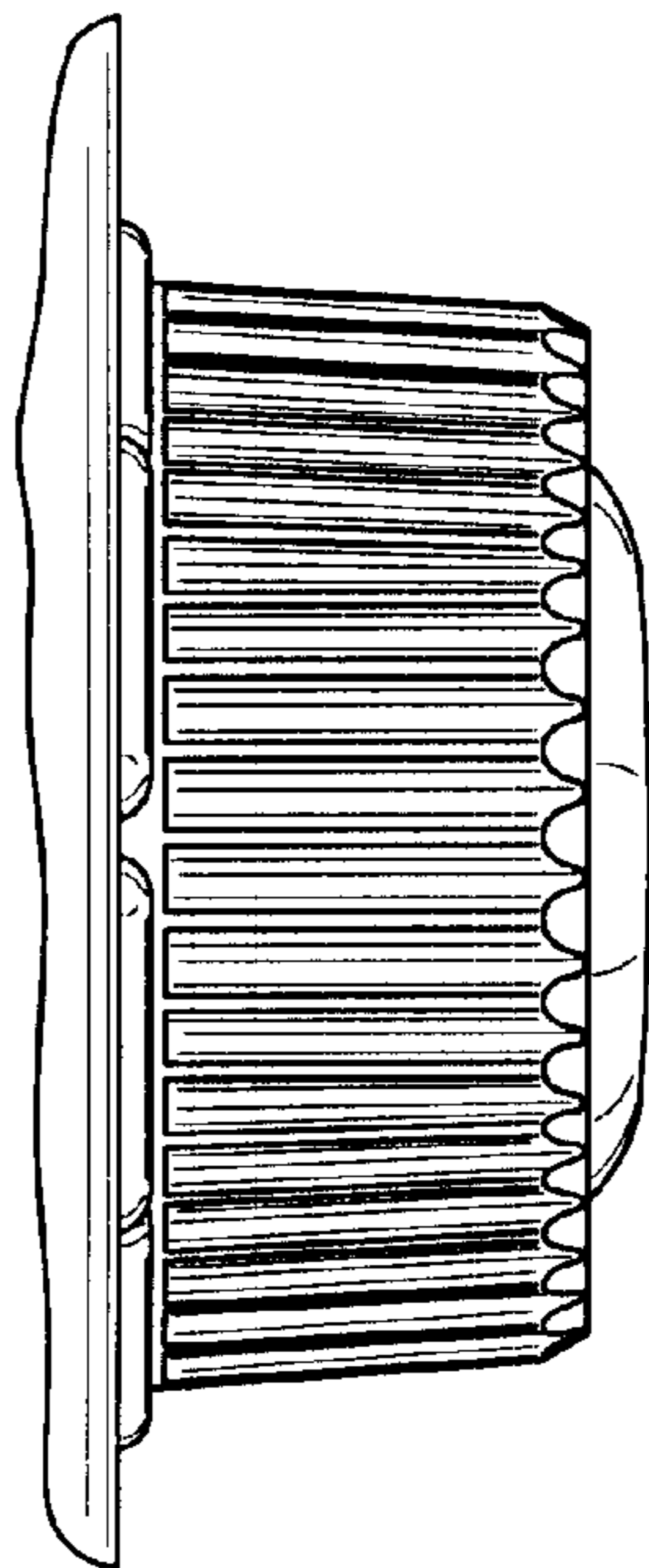

FIG. 5

UNITED STATES PATENT AND TRADEMARK OFFICE
CERTIFICATE OF CORRECTION

PATENT NO. : Des. 459,971 S
DATED : July 9, 2002
INVENTOR(S) : Jon F. Quan and Robert L. Gast

Page 1 of 1

It is certified that error appears in the above-identified patent and that said Letters Patent is hereby corrected as shown below:

Title page,

Illustrative Figure and Drawing sheet 1 of 2, delete FIG. 1 and replace with FIG. 1 as shown below:

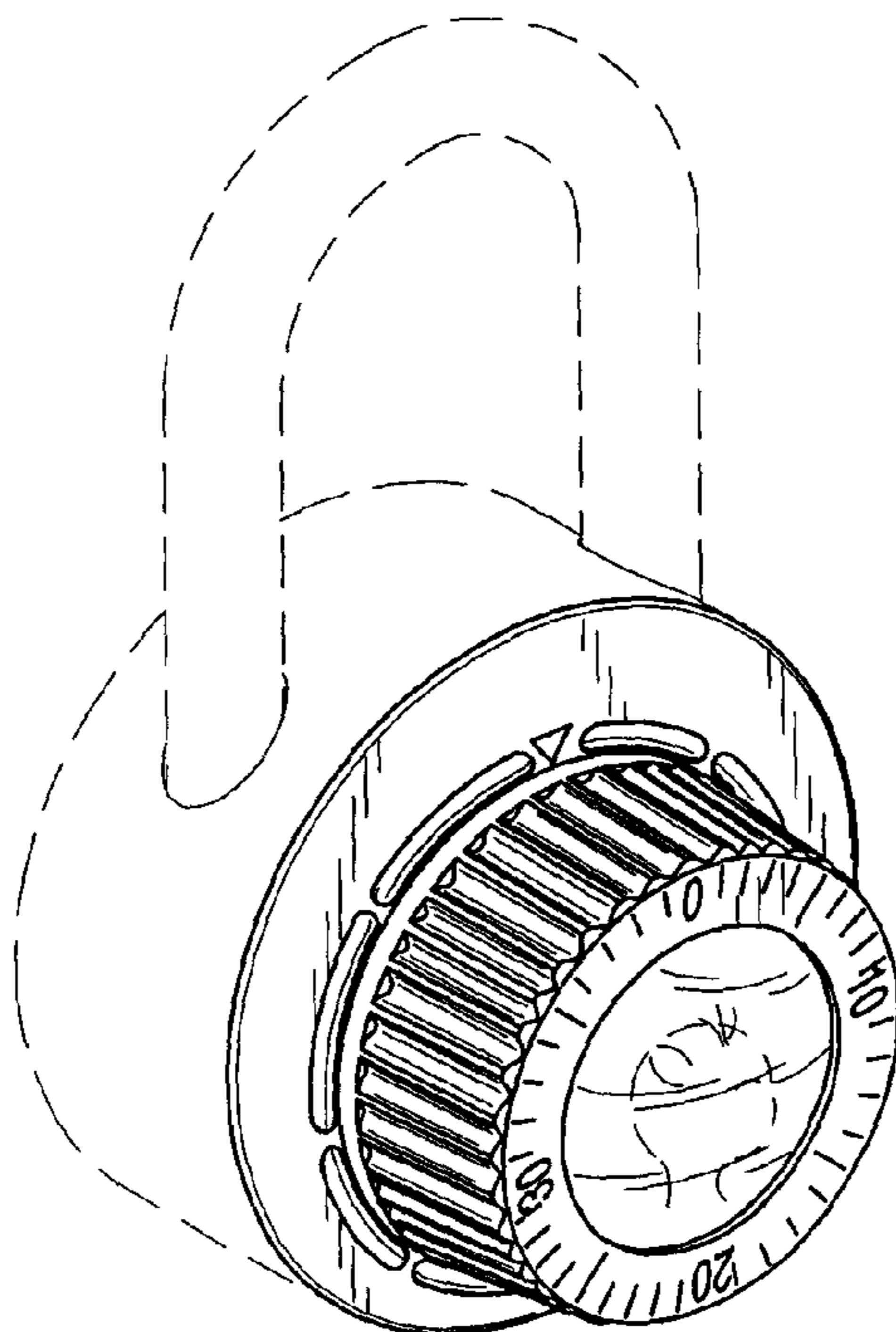

FIG. 1

Signed and Sealed this

Twentieth Day of May, 2003

JAMES E. ROGAN
Director of the United States Patent and Trademark Office