



US00D459962S

(12) **United States Design Patent**  
**Chong**

(10) **Patent No.:** **US D459,962 S**

(45) **Date of Patent:** **\*\* Jul. 9, 2002**

- (54) **HOUSEHOLD CAN OPENER**
- (75) Inventor: **Wun C. Chong**, Delta (CA)
- (73) Assignee: **CanPacific Engineering Inc.**, Delta (CA)
- (\*\*) Term: **14 Years**
- (21) Appl. No.: **29/150,145**
- (22) Filed: **Nov. 9, 2001**
- (51) **LOC (7) Cl.** ..... **07-99**
- (52) **U.S. Cl.** ..... **D8/40**
- (58) **Field of Search** ..... D8/33-43, 18,  
D8/19; 30/400-443, 1.5; 81/3.07-3.49;  
7/151-156

5,946,811 A	*	9/1999	Chang	.....	30/417
6,094,828 A	*	8/2000	Chong	.....	30/417
6,101,727 A		8/2000	Chong	.....	30/418
6,128,368 A1	*	2/2001	So	.....	30/418

**FOREIGN PATENT DOCUMENTS**

GB 1318 of 1912

\* cited by examiner

*Primary Examiner*—Jeffrey Asch

(74) *Attorney, Agent, or Firm*—Oyen Wiggs Green & Mutala

(57) **CLAIM**

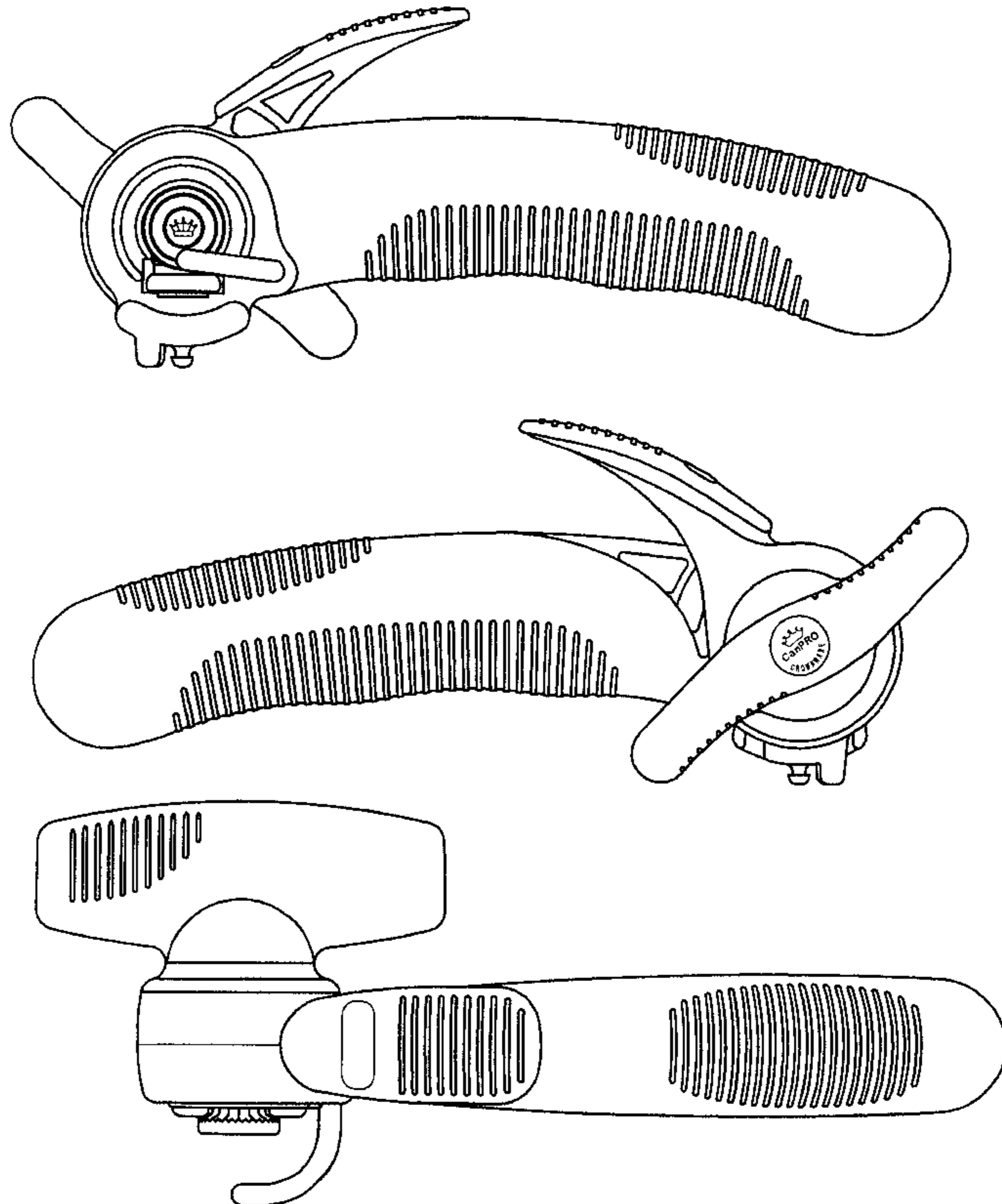
The ornamental design for a household can opener, as shown and described.

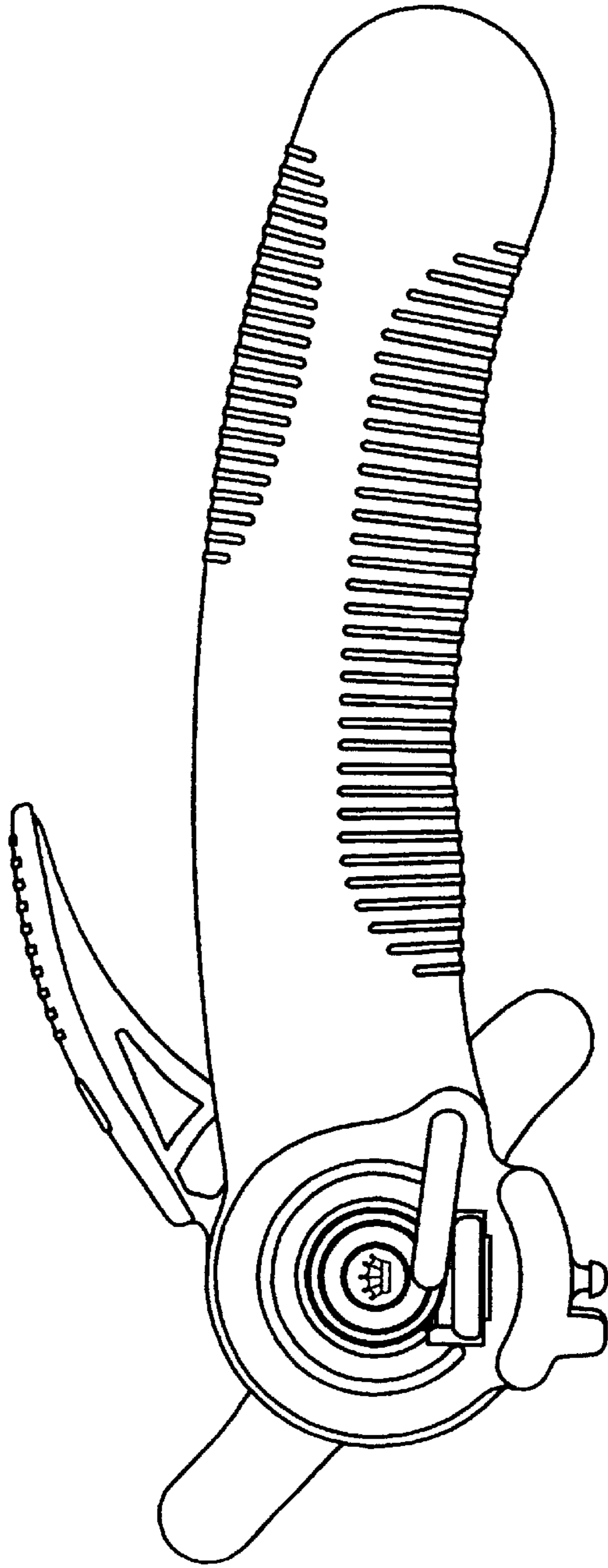
**DESCRIPTION**

FIG. 1 is a front view of the household can opener;  
 FIG. 2 is a back view of the household can opener;  
 FIG. 3 is a top view of the household can opener;  
 FIG. 4 is a bottom view of the household can opener;  
 FIG. 5 is a left hand side view of the household can opener;  
 and,  
 FIG. 6 is a right hand side view of the household can opener.  
 The crown logos, the name "CanPRO" and the name "CROWNWARE" which form a part of the claimed design are registered trademarks of CanPacific Engineering Inc.

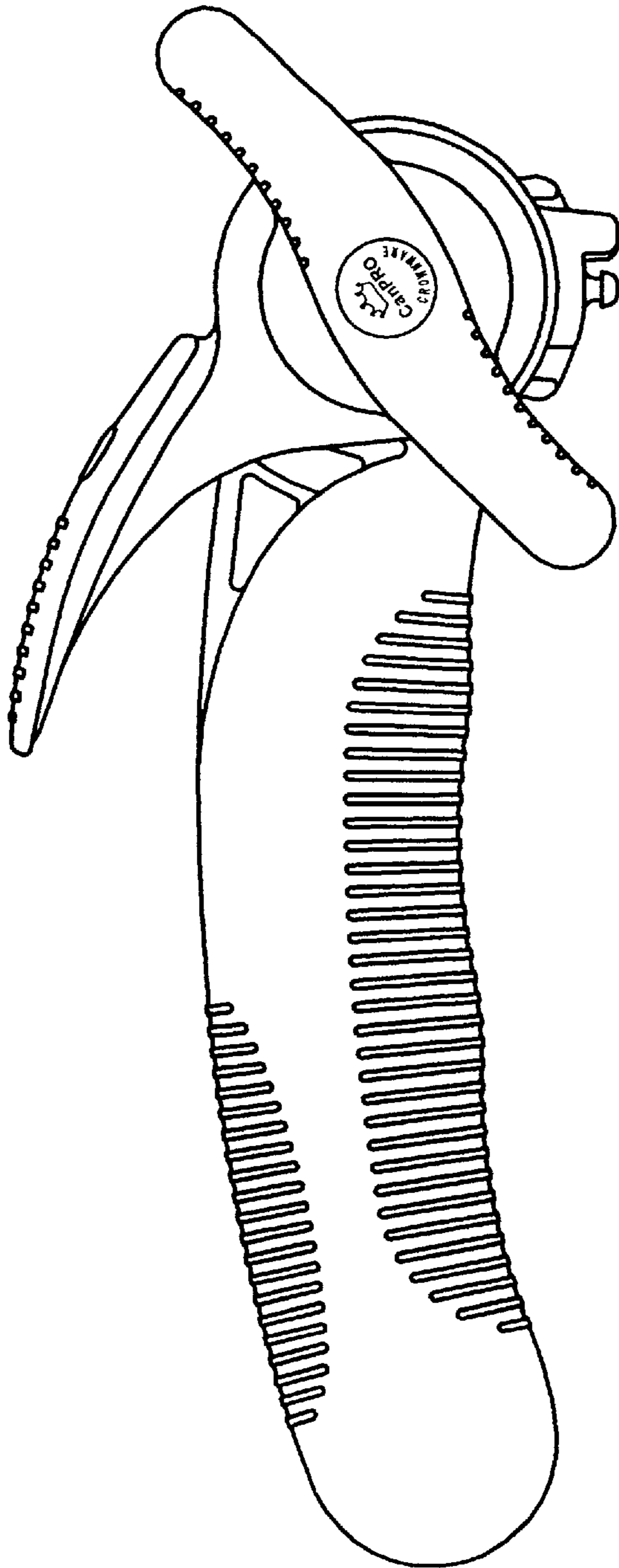
- (56) **References Cited**
- U.S. PATENT DOCUMENTS**
- 1,935,680 A 11/1933 Von Wolforsdorf
- 3,510,941 A 5/1970 Fyfe ..... 30/15.5
- RE27,504 E 10/1972 Smith ..... 30/15.5
- 3,719,991 A 3/1973 French ..... 30/15.5
- D277,926 S \* 3/1985 Chow ..... D8/41
- 4,782,594 A 11/1988 Porucznik et al. .... 30/417
- D326,039 S \* 5/1992 Viemeister ..... D8/33
- 5,121,546 A \* 6/1992 Chong ..... 30/418
- 5,367,776 A \* 11/1994 Chong ..... 30/417
- D393,403 S \* 4/1998 Tse ..... D8/40
- D404,270 S \* 1/1999 Chang ..... D8/40

**1 Claim, 6 Drawing Sheets**

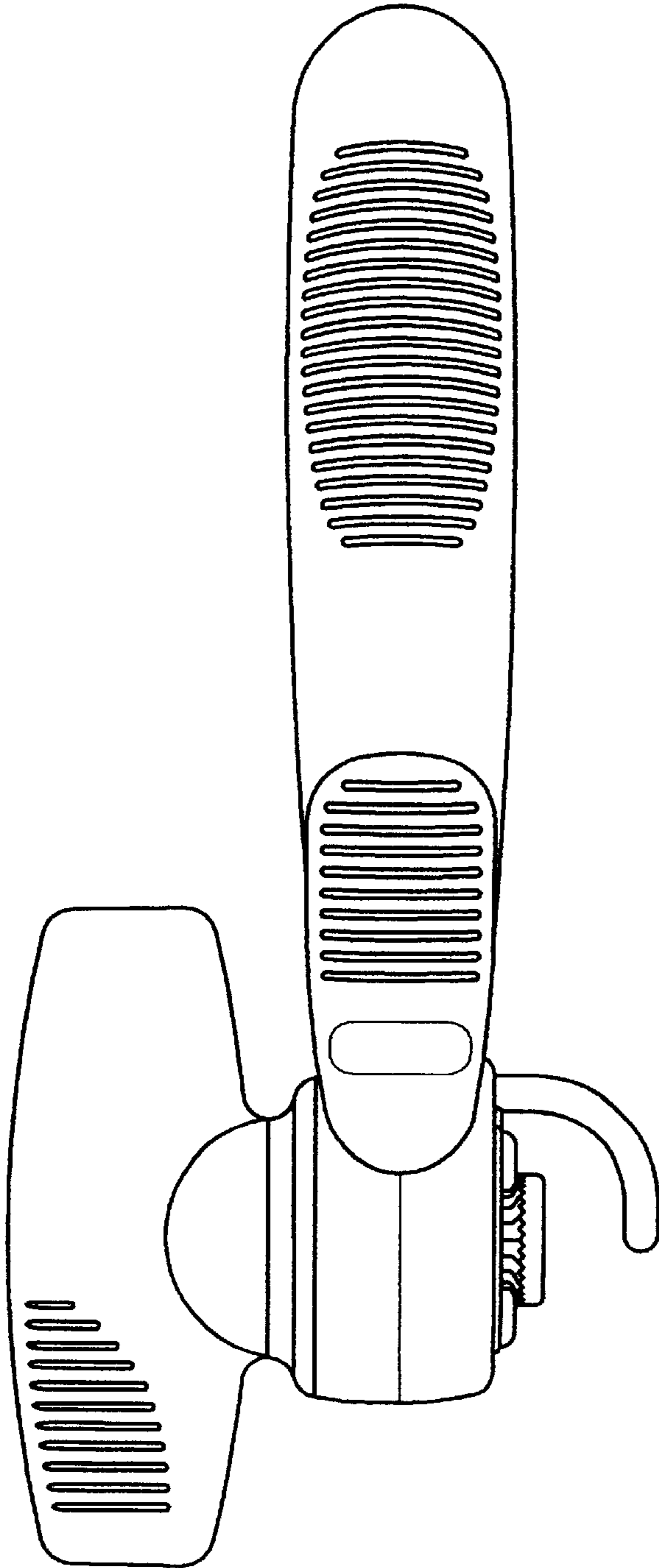




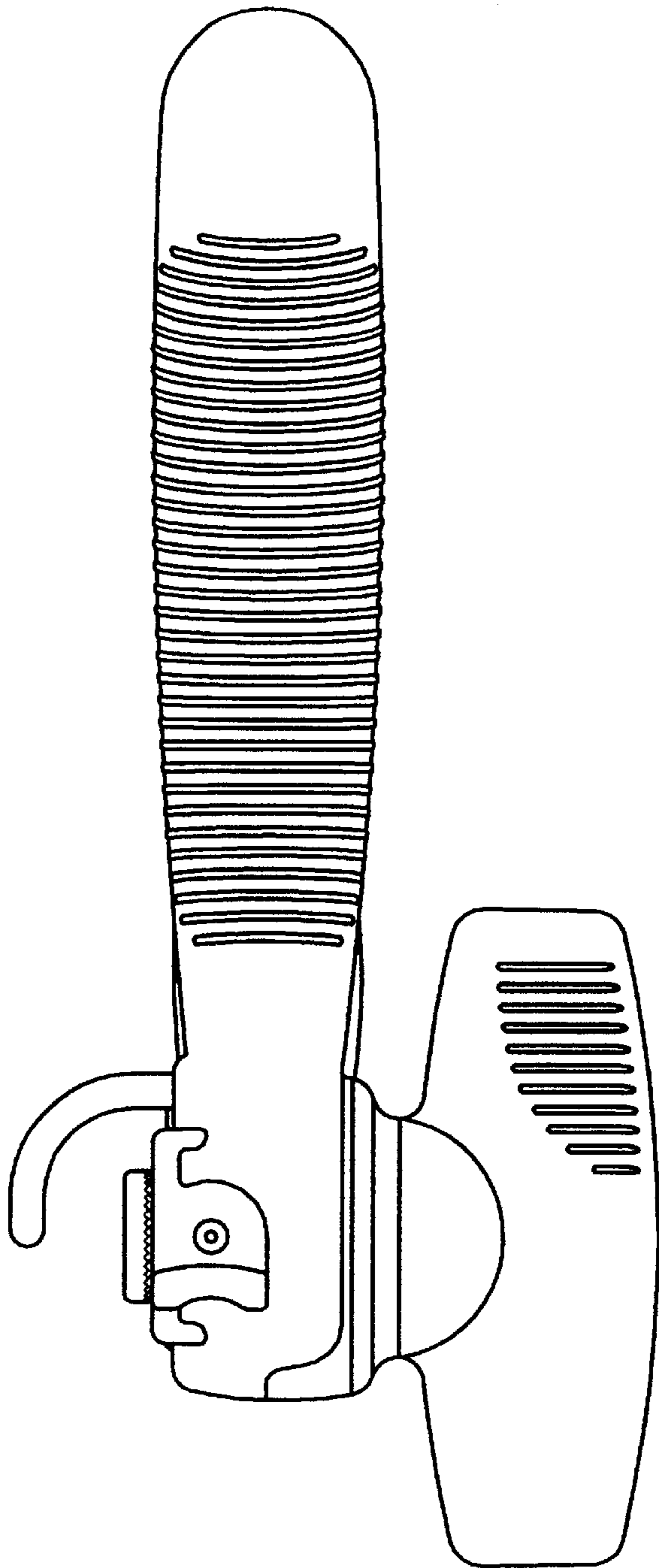
**FIG 1**



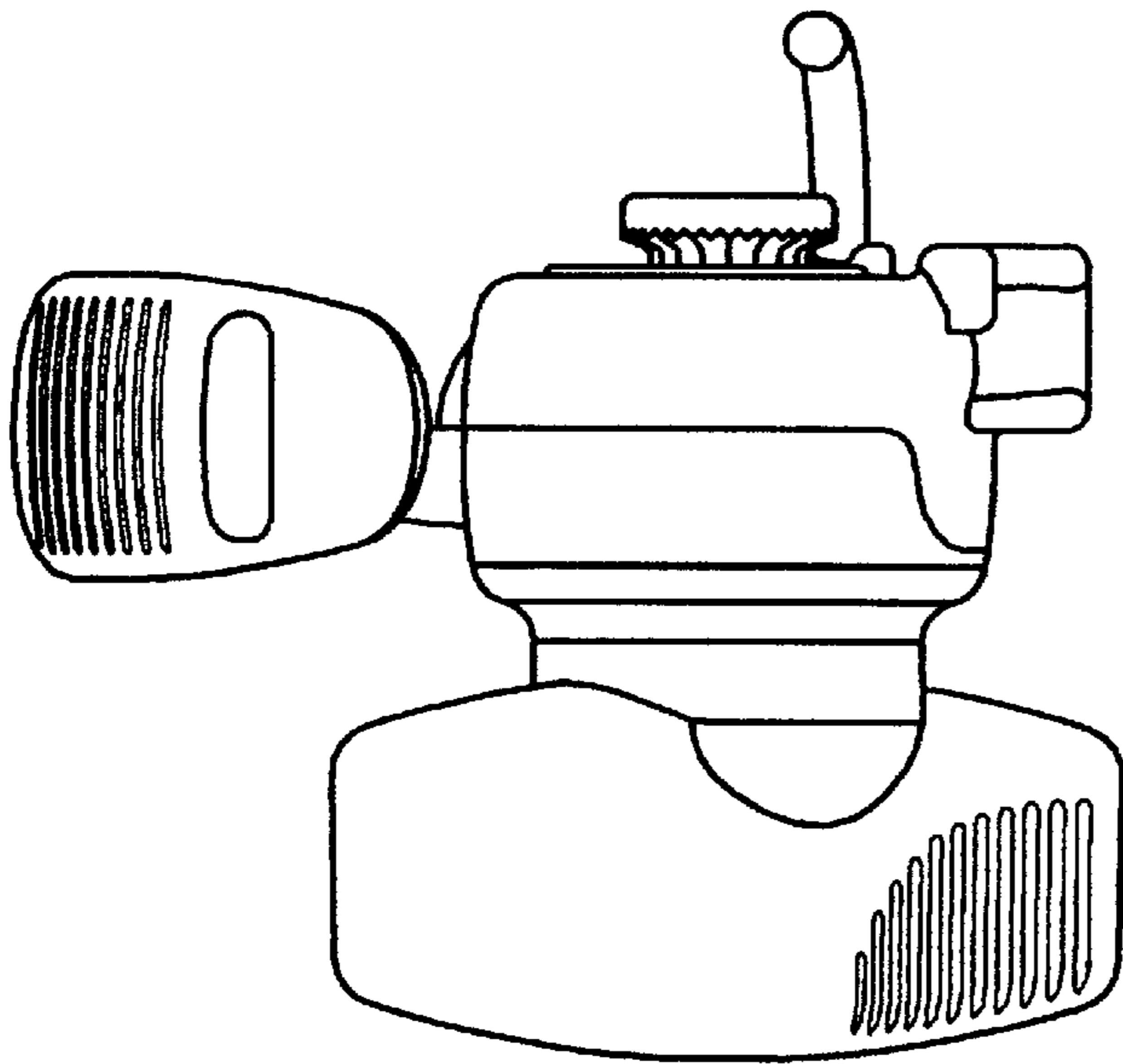
**FIG 2**



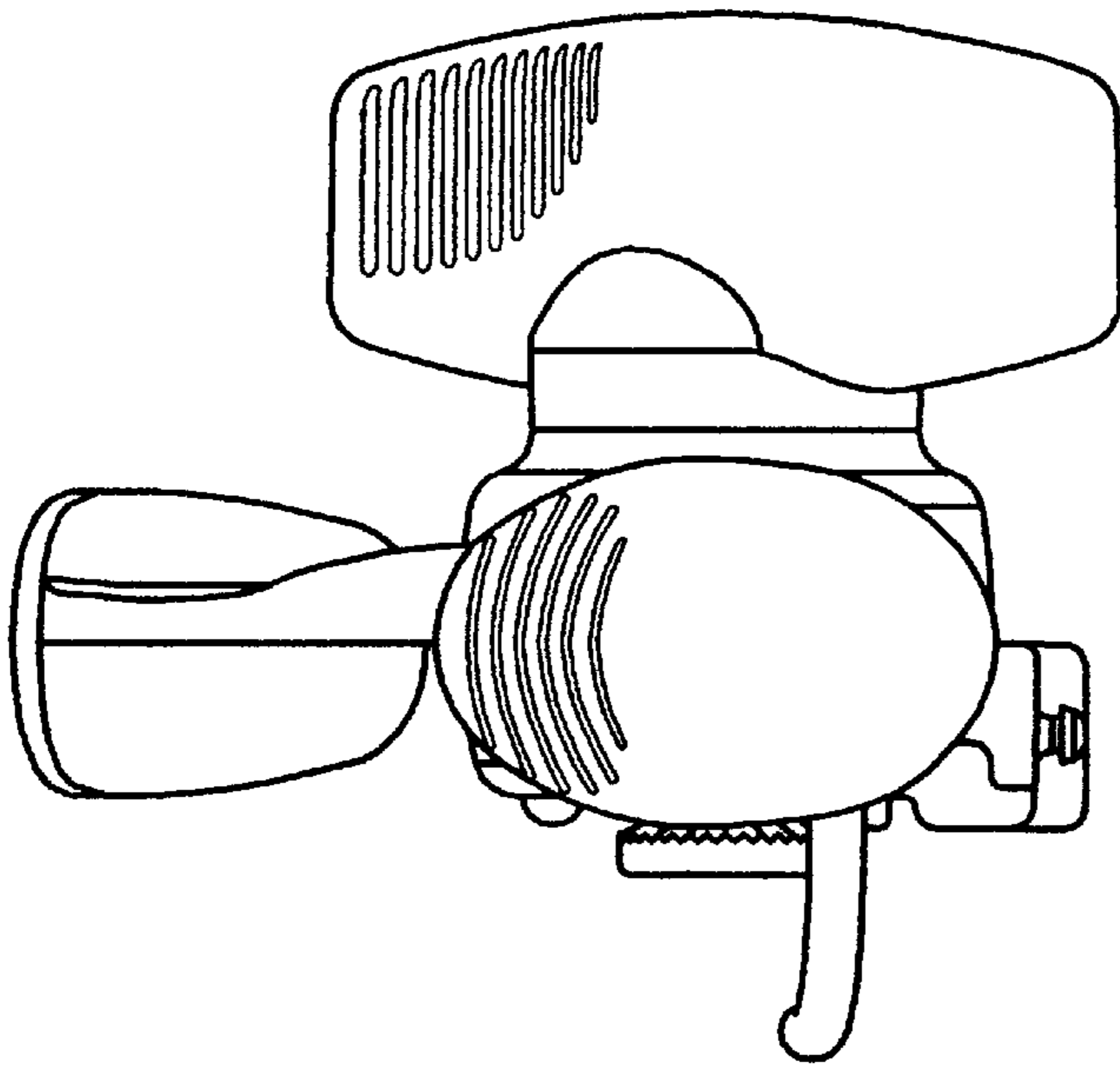
**FIG 3**



**FIG 4**



**FIG 5**



**FIG 6**