



US00D459914S

(12) **United States Design Patent**  
**Grönholm**

(10) **Patent No.:** **US D459,914 S**

(45) **Date of Patent:** **\*\* Jul. 9, 2002**

(54) **STORING STATION FOR ROLL  
CONTAINERS**

5,511,757 A \* 4/1996 Freeland ..... 248/346.03  
D428,157 S \* 7/2000 Coassin et al. .... D25/62

(75) Inventor: **Jack Grönholm**, Söderkulla (FI)

\* cited by examiner

(73) Assignee: **K. Hartwall Oy Ab**, Soderkulla (FI)

*Primary Examiner*—Doris Clark

(\*\*) Term: **14 Years**

(74) *Attorney, Agent, or Firm*—Birch, Stewart, Kolasch & Birch, LLP

(21) Appl. No.: **29/133,724**

(57) **CLAIM**

(22) Filed: **Dec. 6, 2000**

The ornamental design for storing station for roll containers, as shown and described.

(30) **Foreign Application Priority Data**

**DESCRIPTION**

Jun. 6, 2000 (FI) ..... M-20000405  
Jun. 6, 2000 (FI) ..... M-20000406

FIG. 1 is a side elevational view of a storing station for roll containers showing my new design;

(51) **LOC (7) Cl.** ..... **06-04**

FIG. 2 is a bottom perspective view thereof;

(52) **U.S. Cl.** ..... **D6/462; D25/62**

FIG. 3 is a top right side perspective view thereof;

(58) **Field of Search** ..... D25/138, 50, 62;  
D6/462; 256/1; 248/346.01, 346.03; 211/17

FIG. 4 is a top left side perspective view thereof;

FIG. 5 is a side elevational view of a second embodiment of the present invention;

(56) **References Cited**

FIG. 6 is a top left side perspective view thereof;

FIG. 7 is a top right side perspective view thereof; and,

**U.S. PATENT DOCUMENTS**

FIG. 8 is a bottom left side perspective view thereof.

D350,038 S \* 8/1994 Buckley ..... D6/462

**1 Claim, 7 Drawing Sheets**

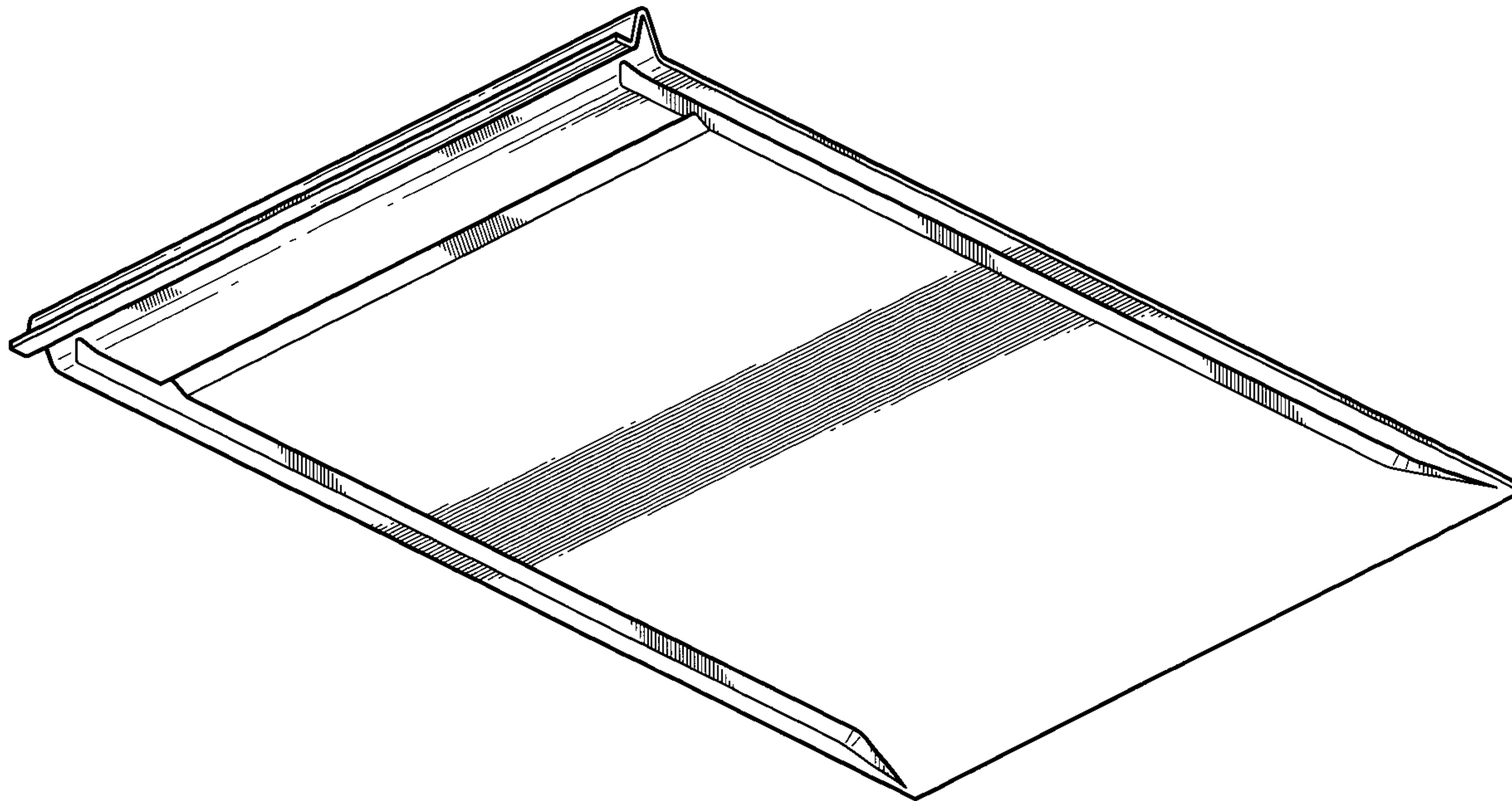

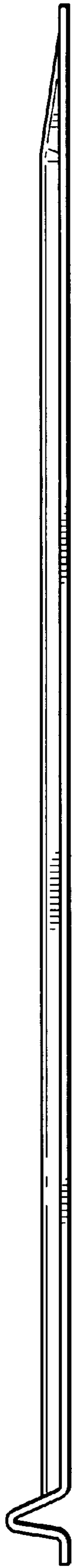

FIG. 1



FIG. 5

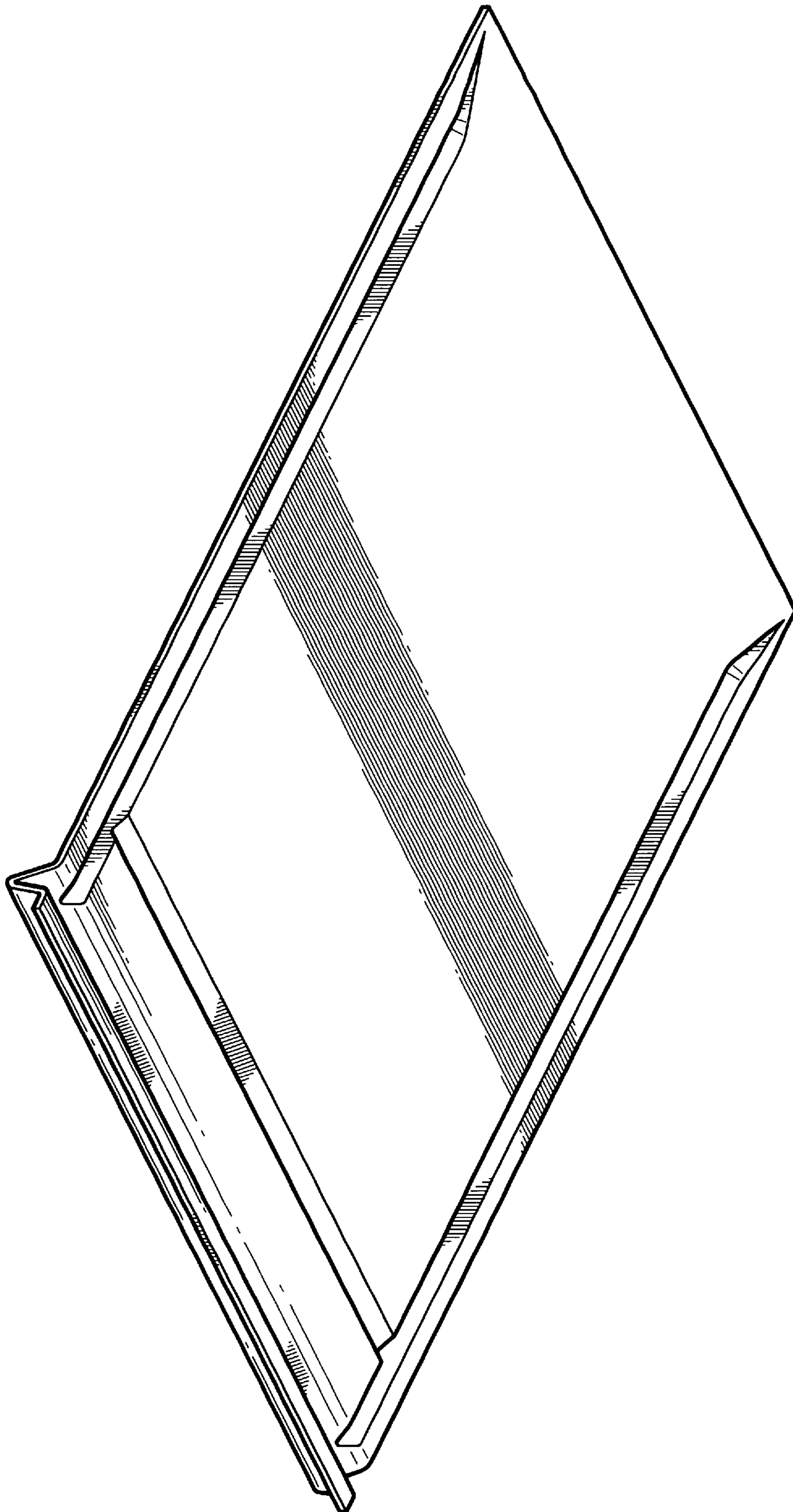

FIG.2

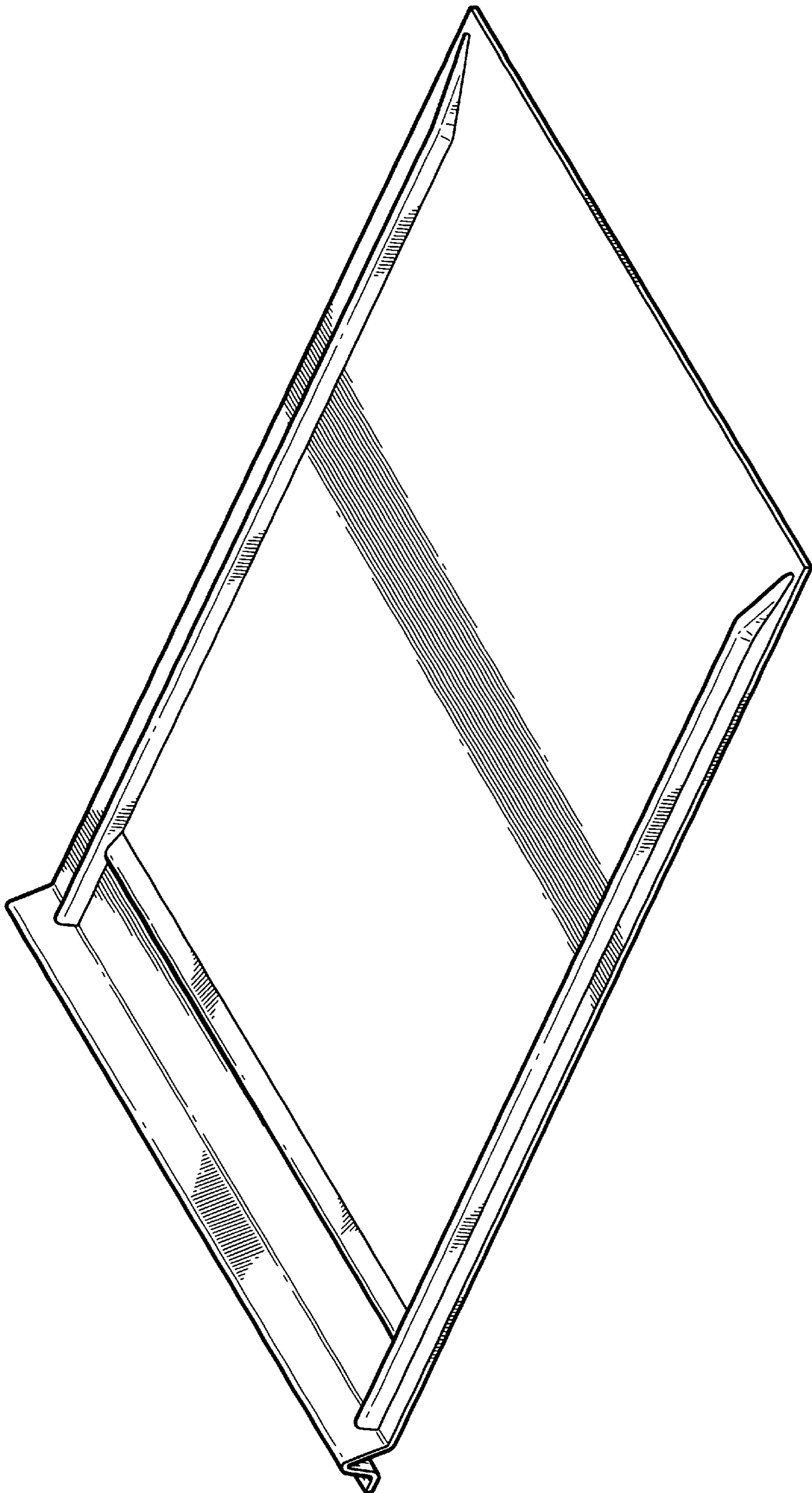

FIG.3

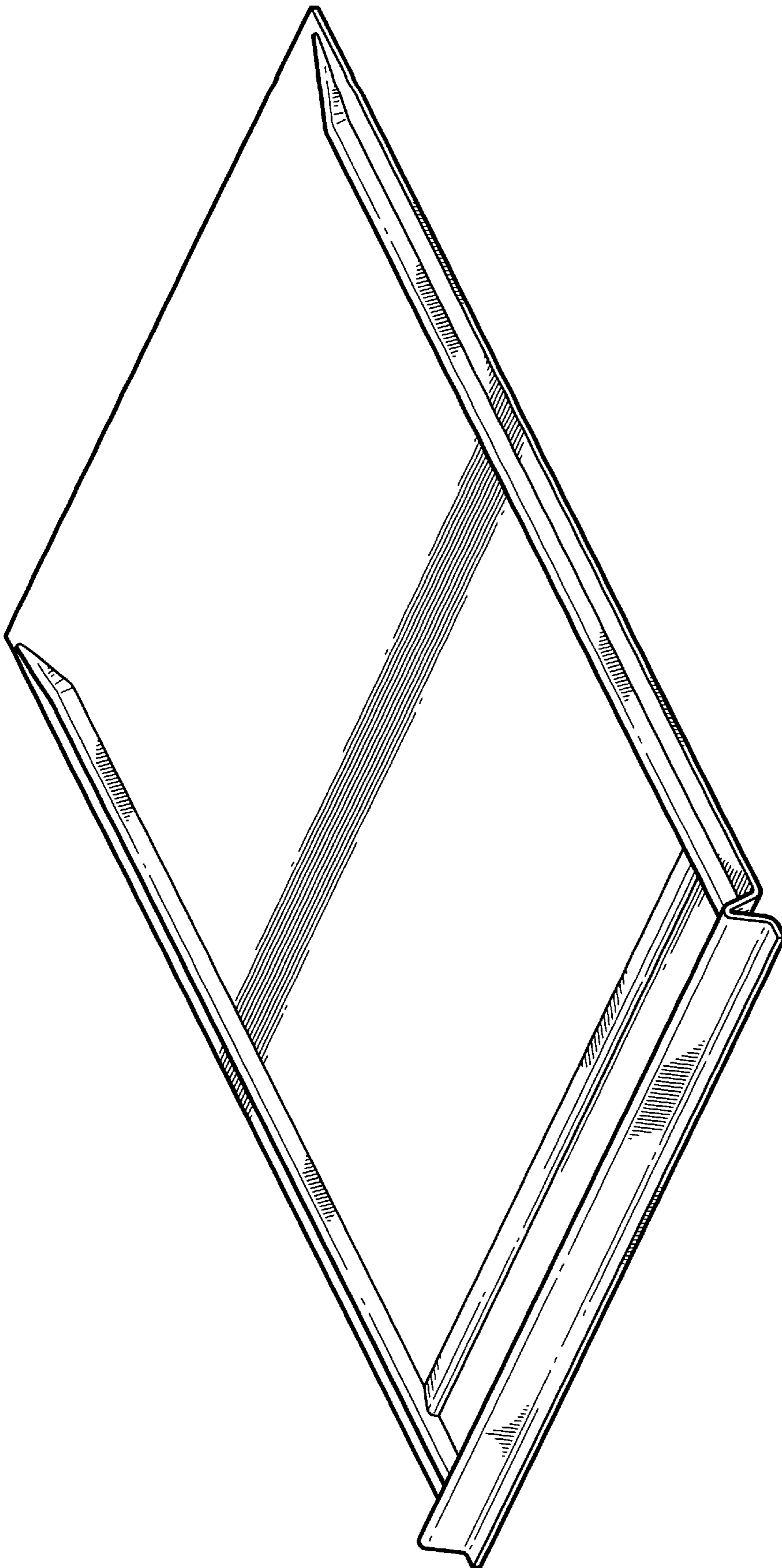

FIG.4

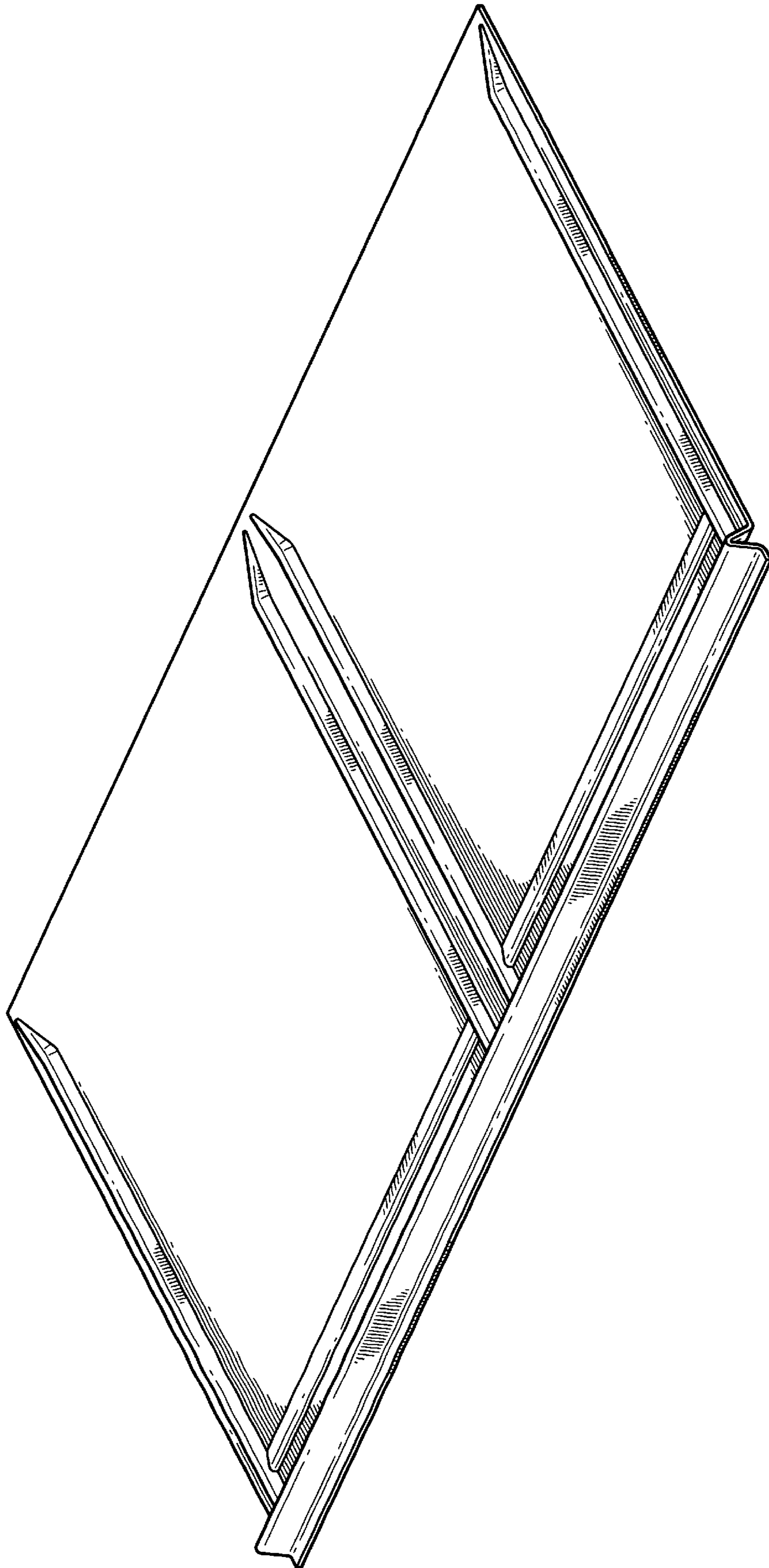

FIG.6

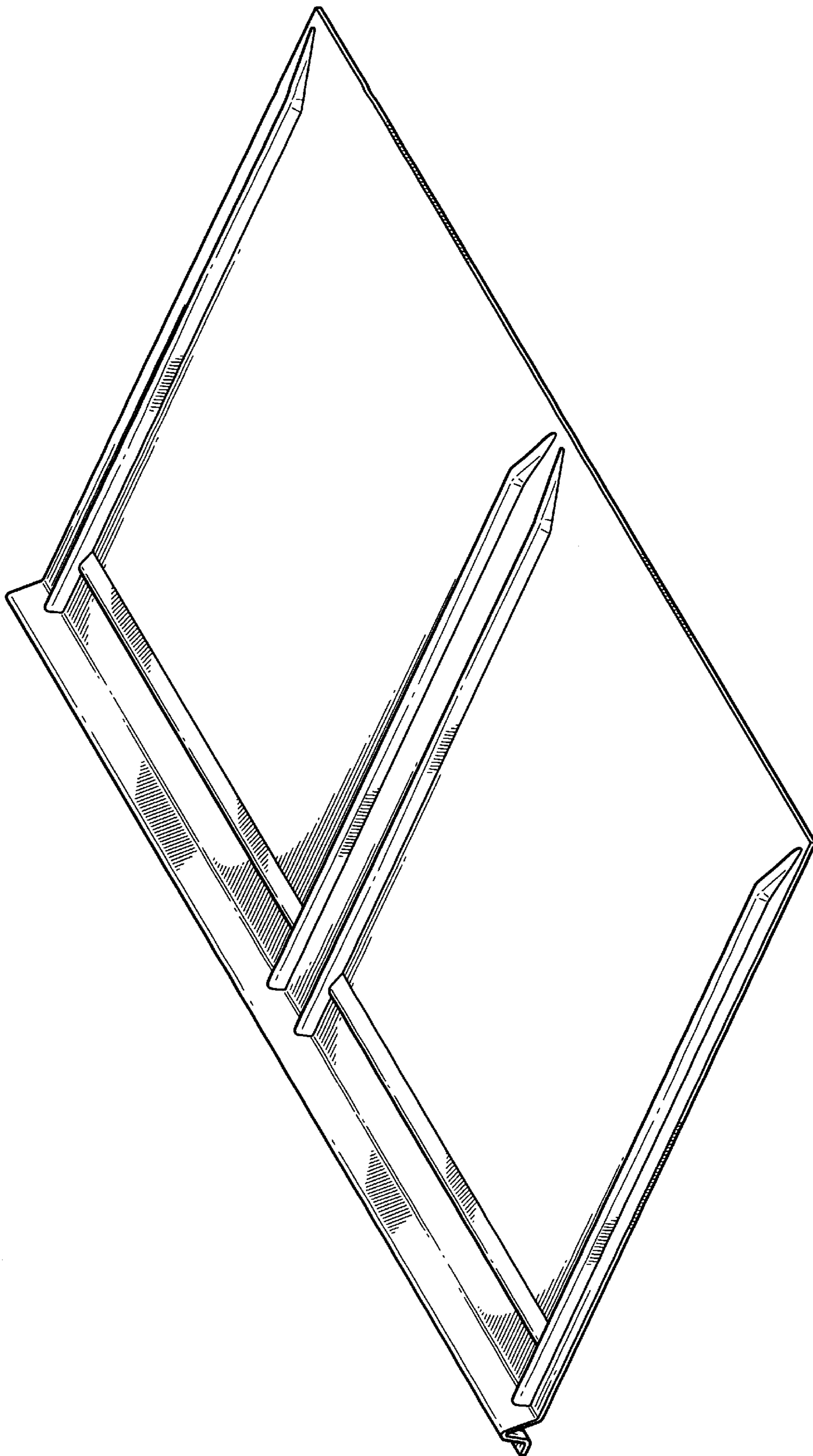

FIG.7

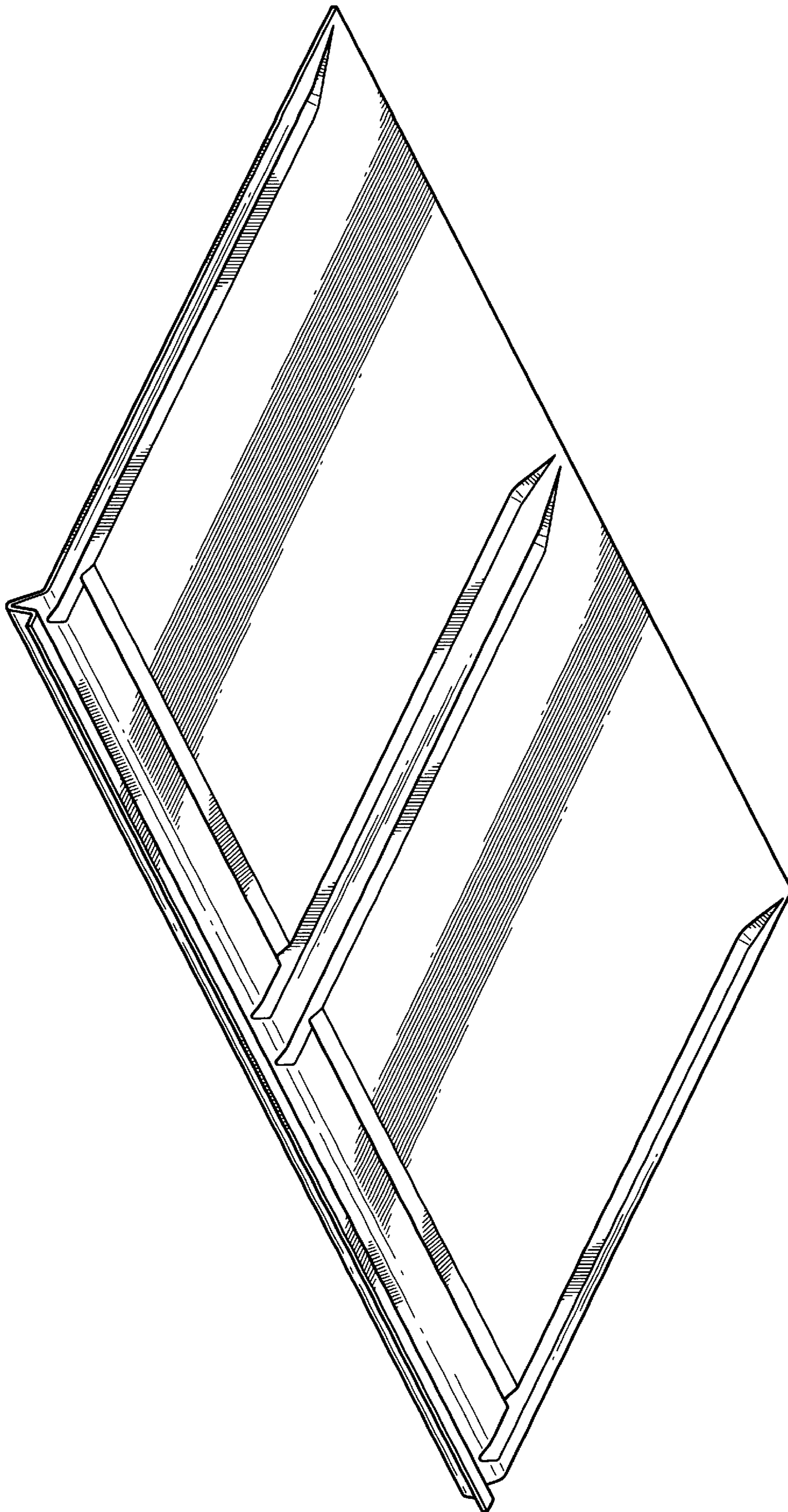

FIG.8