



US00D459752S

(12) **United States Design Patent**
Shiozaki

(10) **Patent No.:** **US D459,752 S**

(45) **Date of Patent:** **** Jul. 2, 2002**

(54) **PHOTOCOPIER**

D443,887 S * 6/2001 Ogawa et al. D18/39
D451,124 S * 11/2001 Isomoto D18/39

(75) Inventor: **Akihisa Shiozaki**, Fujisawa (JP)

* cited by examiner

(73) Assignee: **Canon Kabushiki Kaisha**, Tokyo (JP)

Primary Examiner—Caron D. Veynar

(**) Term: **14 Years**

(74) *Attorney, Agent, or Firm*—Fitzpatrick, Cella, Harper & Scinto

(21) Appl. No.: **29/150,327**

(57) **CLAIM**

(22) Filed: **Nov. 21, 2001**

The ornamental design for a photocopier, as shown and described.

(30) **Foreign Application Priority Data**

DESCRIPTION

Jun. 7, 2001 (JP) 2001-016603

(51) **LOC (7) Cl.** **16-03**

(52) **U.S. Cl.** **D18/36**

(58) **Field of Search** D18/36-39, 53-56;
399/1-7, 81, 130; 355/97

FIG. 1 is a front view of a photocopier showing my new design;

FIG. 2 is a rear view thereof;

FIG. 3 is a top plan view thereof;

FIG. 4 is a bottom plan view thereof;

FIG. 5 is a left side view thereof;

FIG. 6 is a right side view thereof; and,

FIG. 7 is a perspective view thereof.

(56) **References Cited**

U.S. PATENT DOCUMENTS

D423,040 S * 4/2000 Ohta et al. D18/36

1 Claim, 7 Drawing Sheets

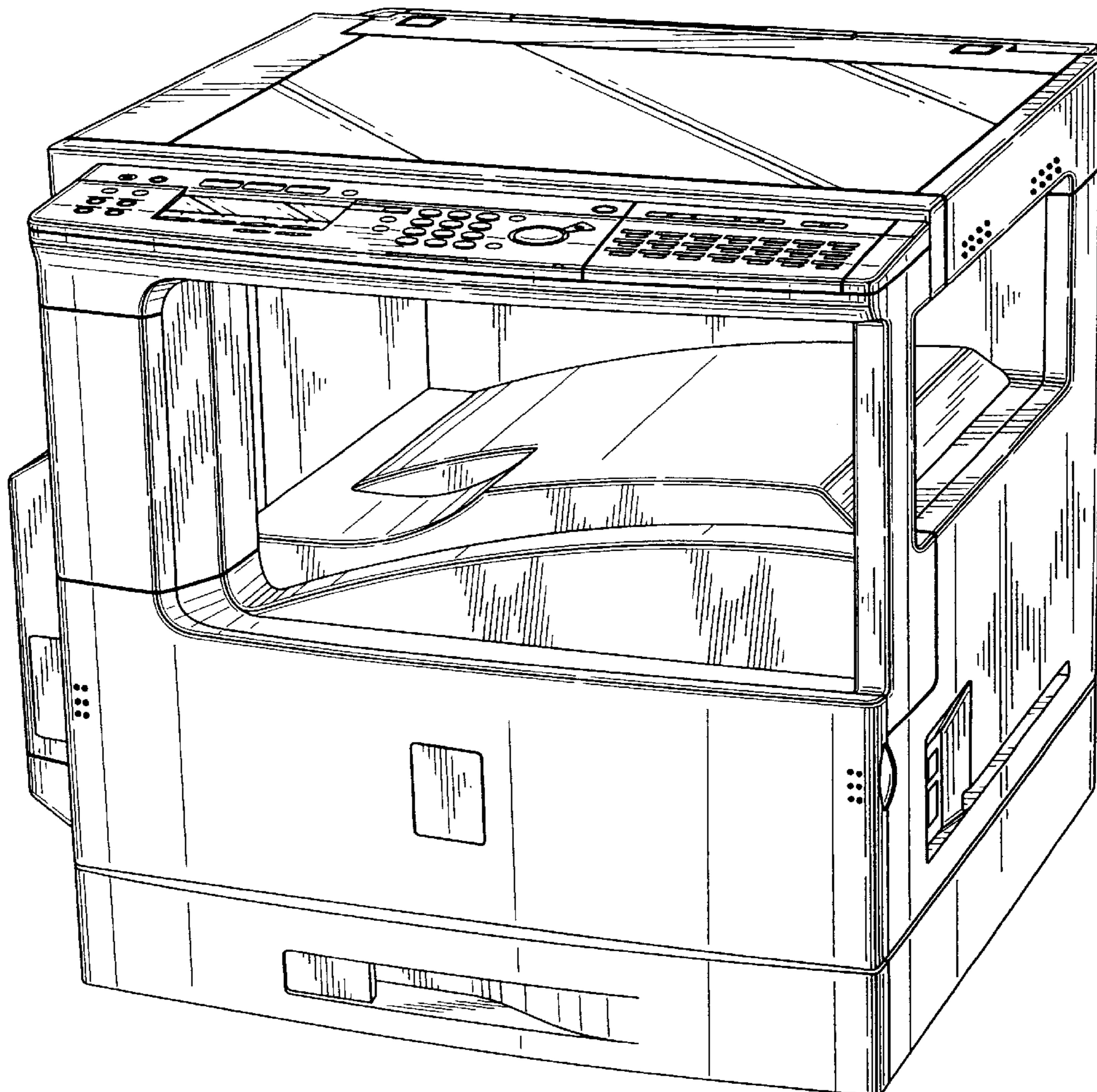

FIG. 1

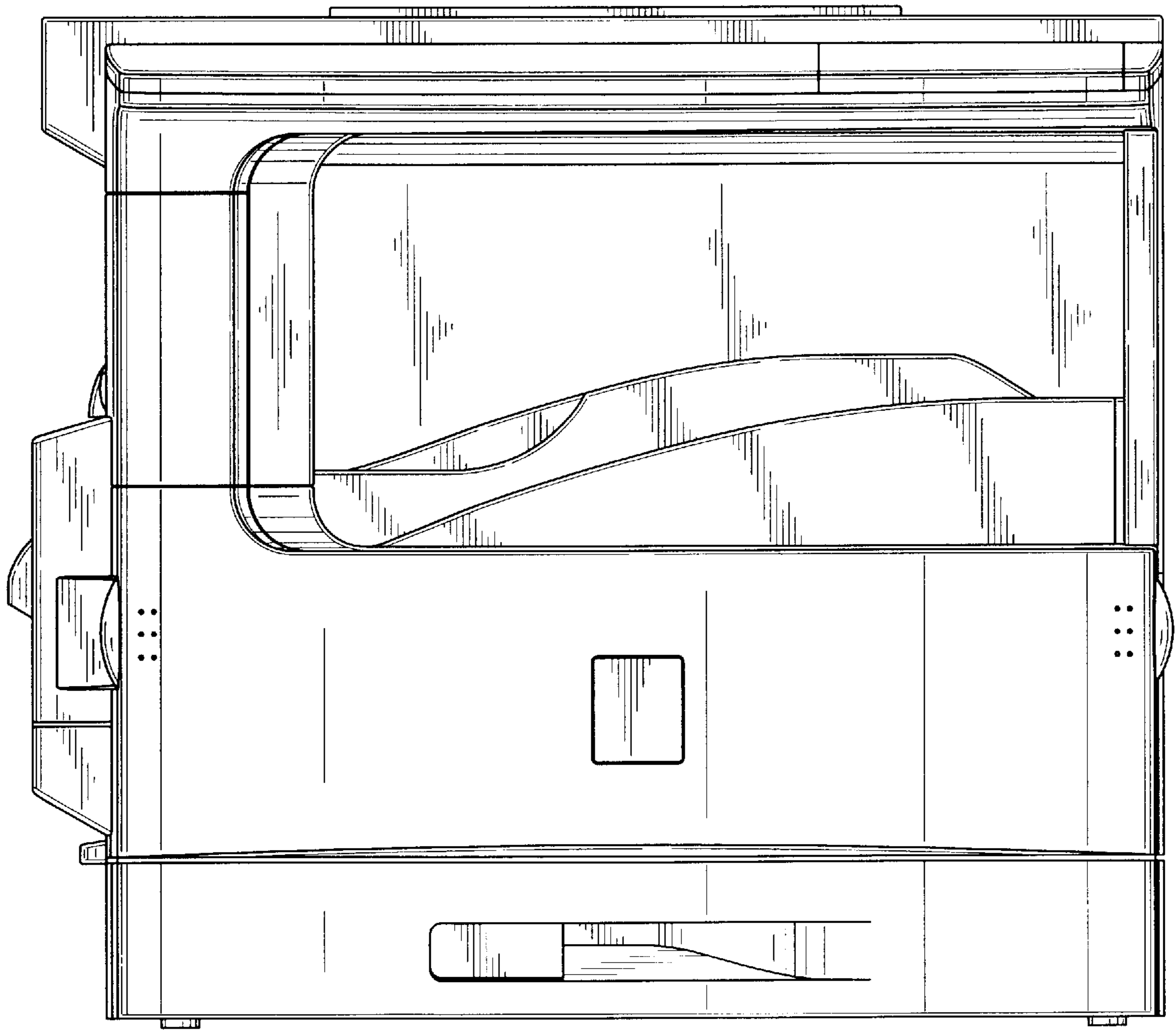

FIG. 2

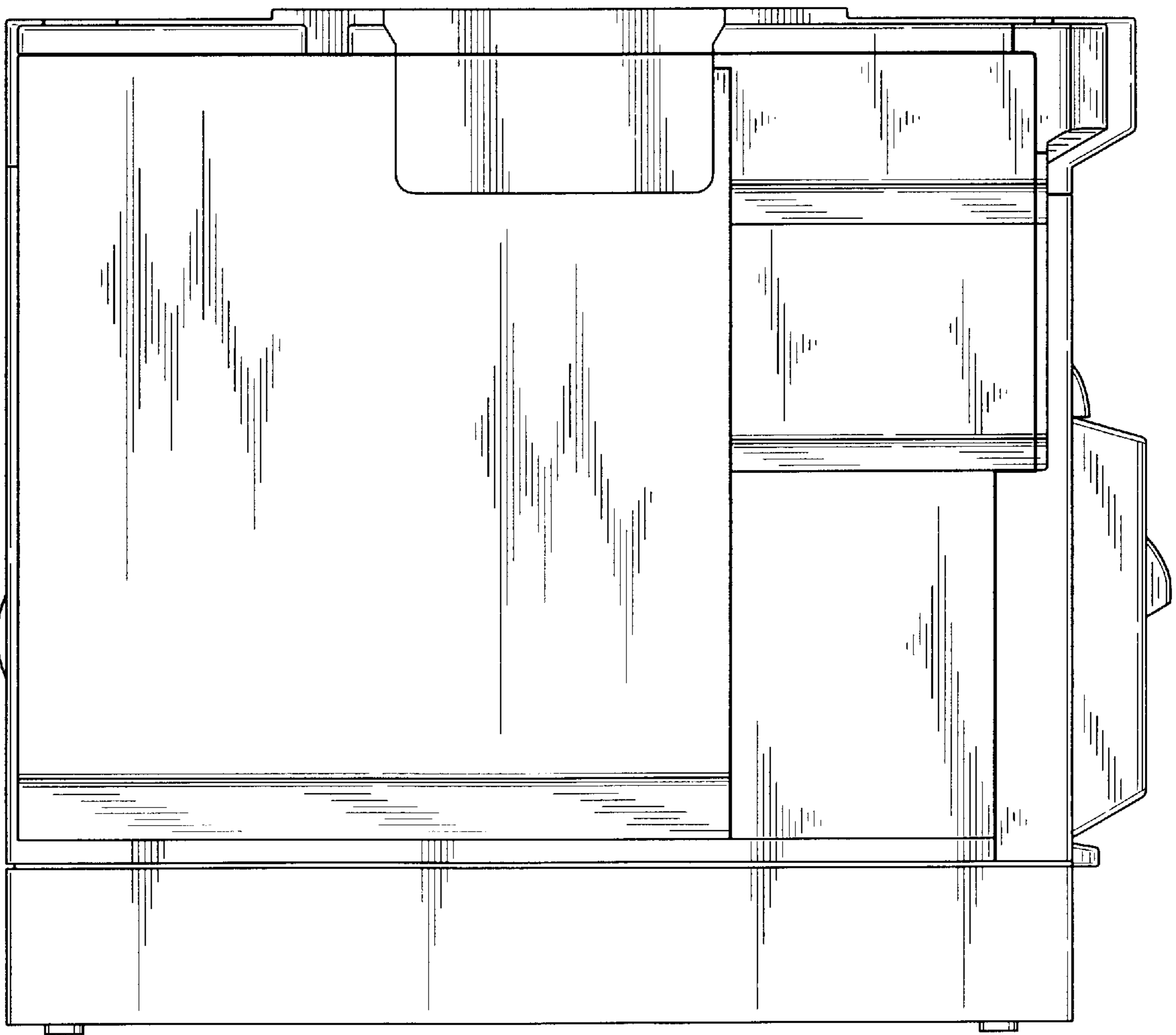

FIG. 3

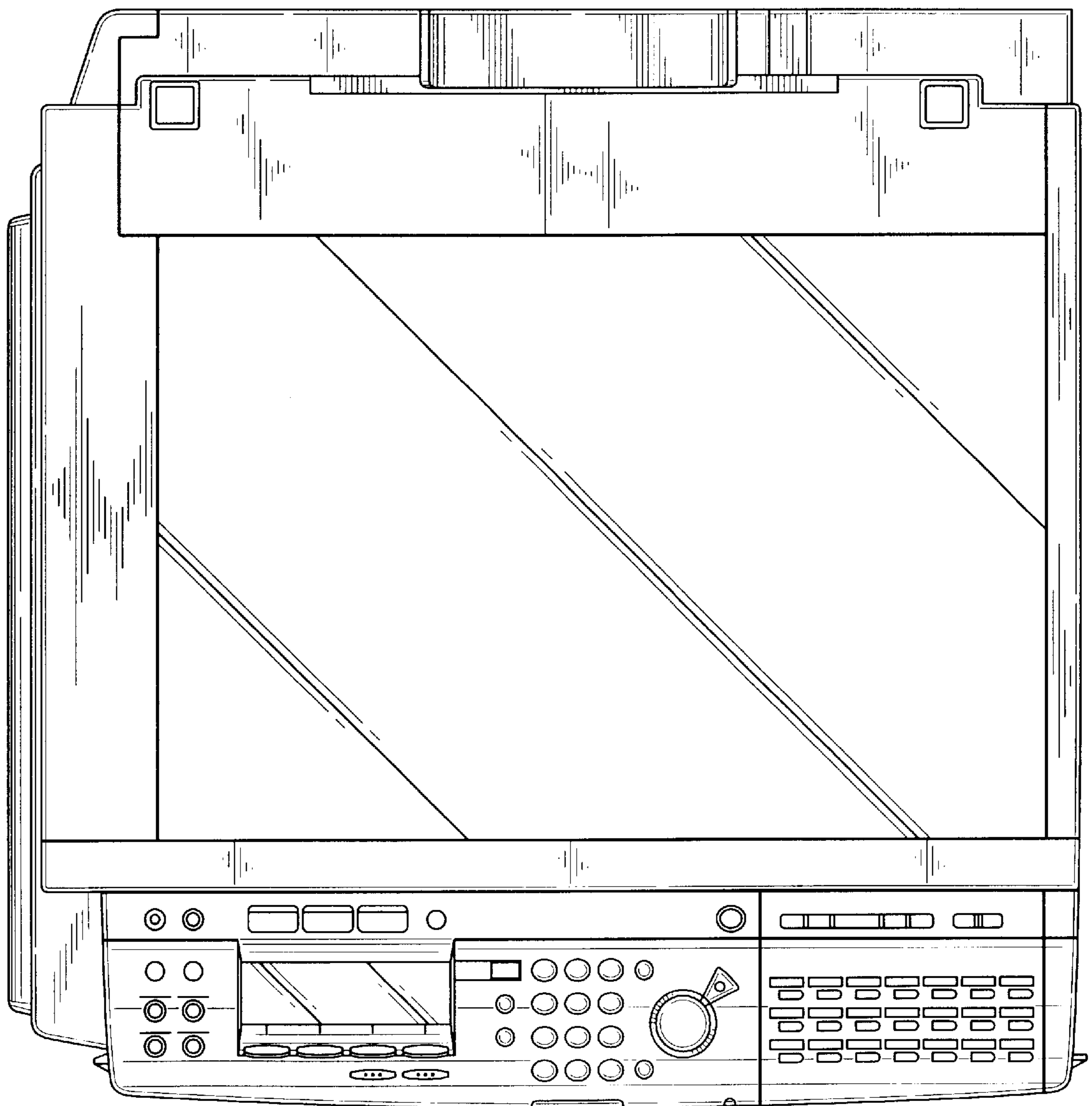

FIG. 4

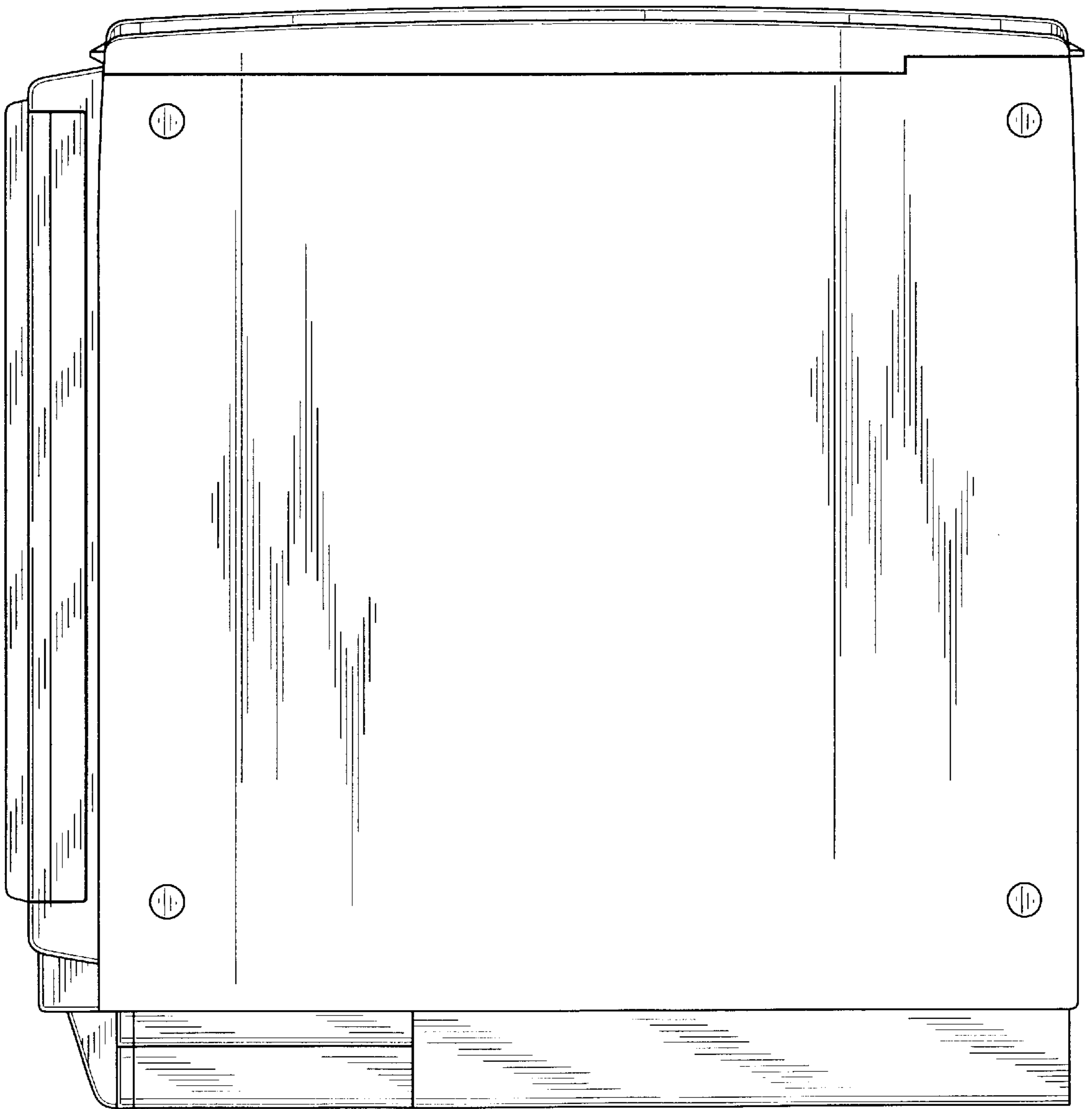

FIG. 5

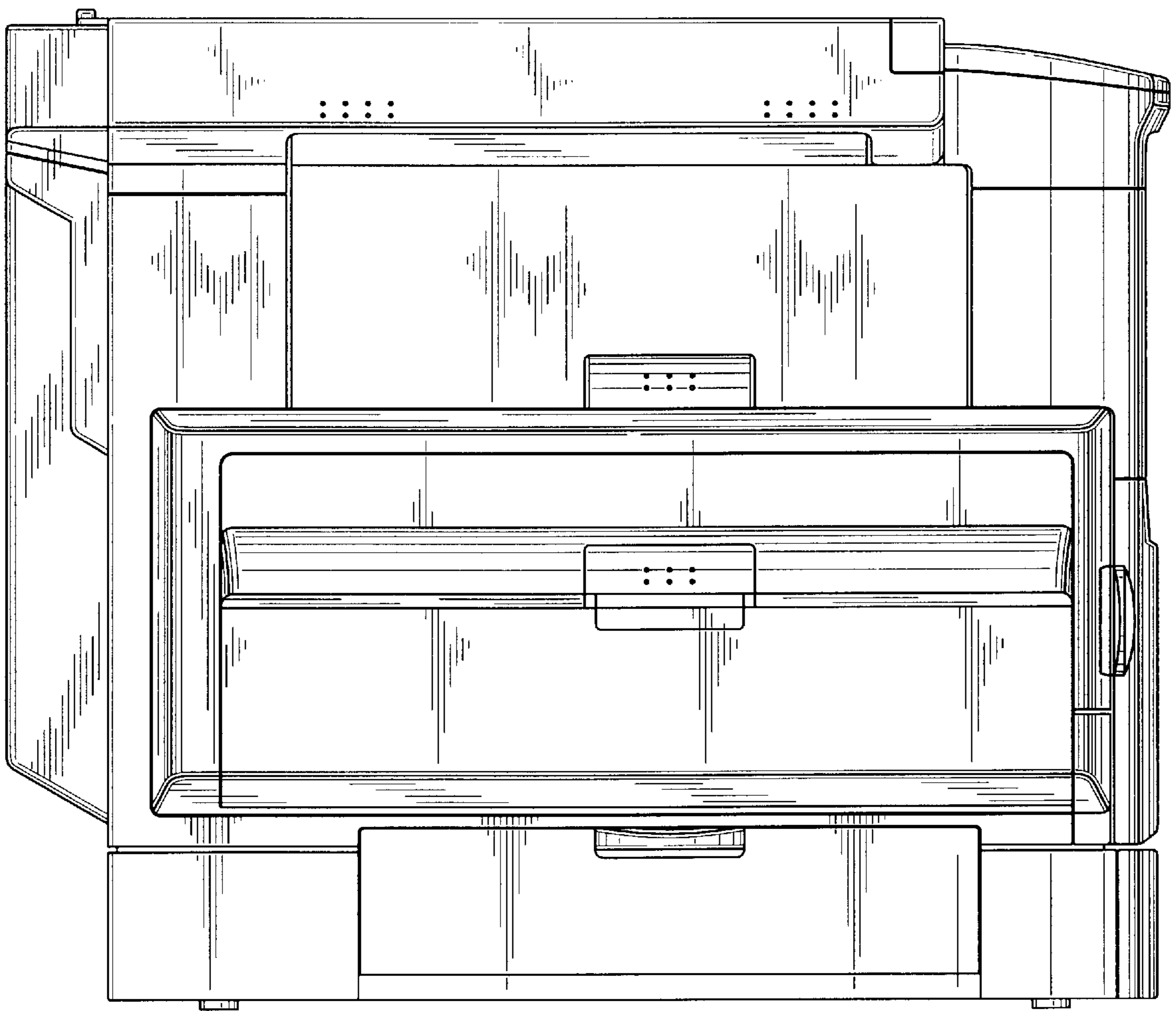

FIG. 6

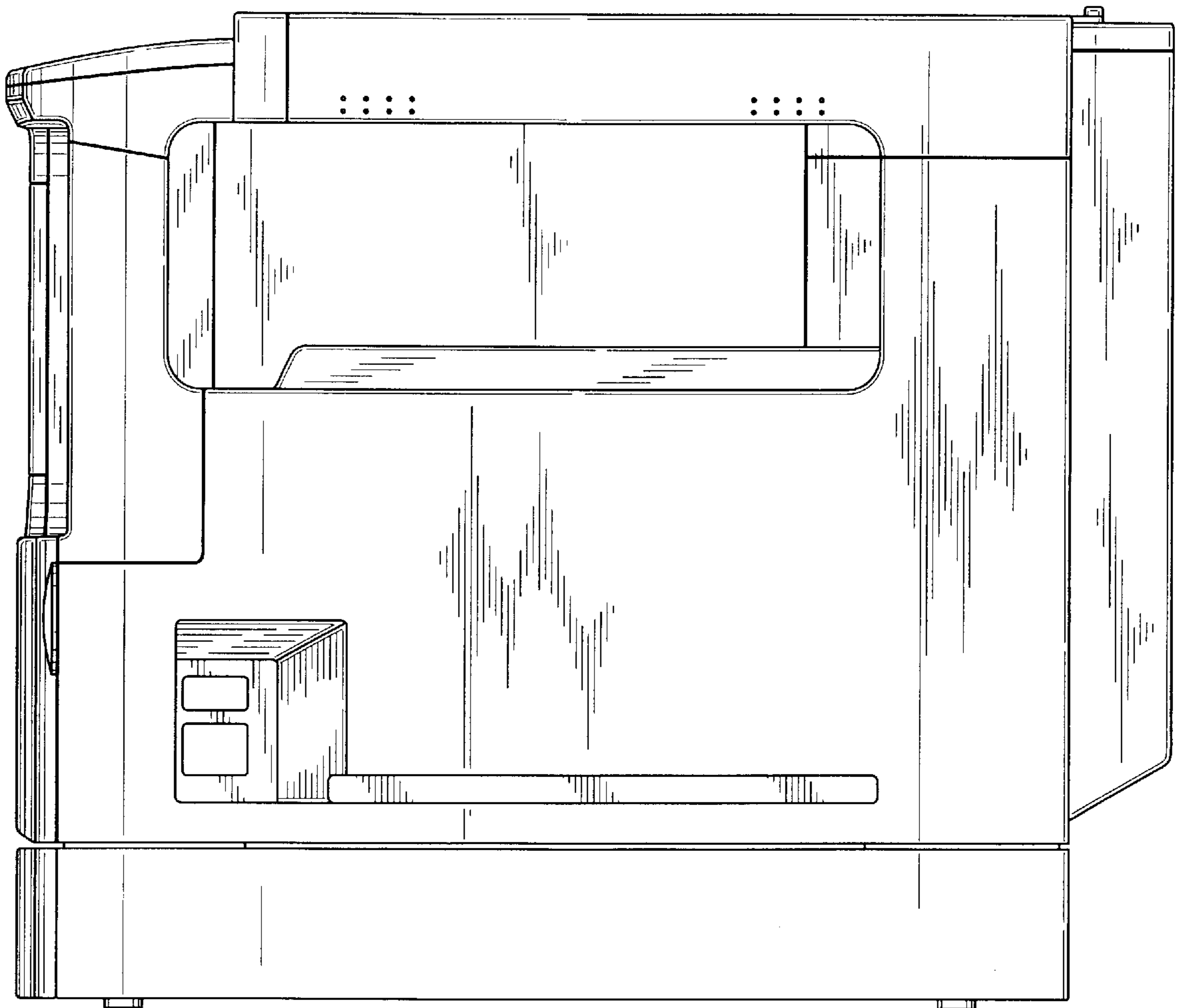

FIG. 7

