



US00D459704S

(12) **United States Design Patent**
Chen

(10) **Patent No.:** **US D459,704 S**

(45) **Date of Patent:** **** Jul. 2, 2002**

(54) **CONNECTOR HOUSING**

(75) Inventor: **Ping Chen**, West Bloomfield, MI (US)

(73) Assignee: **J.S.T. Mfg. Co., Ltd.**, Osaka (JP)

(**) Term: **14 Years**

(21) Appl. No.: **29/146,343**

(22) Filed: **Aug. 9, 2001**

(30) **Foreign Application Priority Data**

Feb. 14, 2001 (JP) 2001-003141

(51) **LOC (7) Cl.** **13-03**

(52) **U.S. Cl.** **D13/147**

(58) **Field of Search** D13/147; 439/350,
439/352, 354, 358, 489, 595, 680, 752

(56) **References Cited**

U.S. PATENT DOCUMENTS

4,674,814 A	*	6/1987	Hoshino et al.	439/372 X
4,884,978 A	*	12/1989	Inaba et al.	439/352
D311,380 S	*	10/1990	Kameyama et al.	D13/147
5,067,913 A	*	11/1991	Sagawa	439/595
5,104,253 A	*	4/1992	Zielinski et al.	439/357 X
D328,590 S	*	8/1992	Tanaka	D13/147
5,437,559 A	*	8/1995	Okumura et al.	439/352 X

5,700,162 A	*	12/1997	Hatagishi et al.	439/595
6,203,351 B1	*	3/2001	Okabe	439/352
6,296,531 B1	*	10/2001	Nagamine	439/752
2001/0021603 A1	*	9/2001	Chen	439/358

* cited by examiner

Primary Examiner—Joel Sincavage

(74) *Attorney, Agent, or Firm*—Antonelli, Terry, Stout & Kraus, LLP

(57) **CLAIM**

The ornamental design for a connector housing, as shown and described.

DESCRIPTION

FIG. 1 is a top plan view thereof;
 FIG. 2 is a front elevation thereof;
 FIG. 3 is a bottom plan view thereof;
 FIG. 4 is a right-side elevation thereof;
 FIG. 5 is a rear elevation thereof;
 FIG. 6 is a cross section taken along the line 6—6 in FIG. 2; and,
 FIG. 7 is a perspective view.

A left-side elevation of the connector housing is symmetrical with the right-side elevation, and is therefore excluded from the drawings.

1 Claim, 3 Drawing Sheets

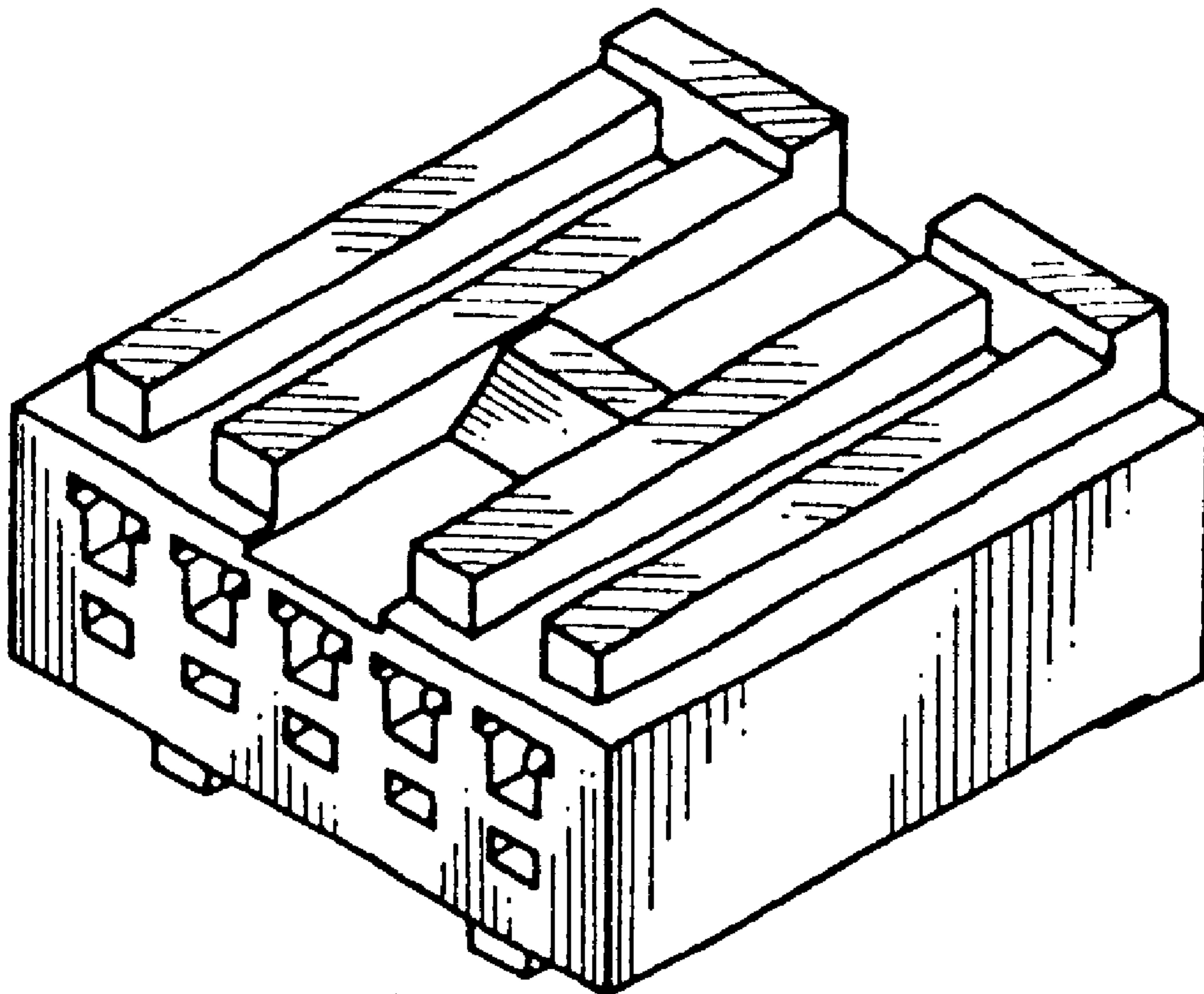

Fig. 1

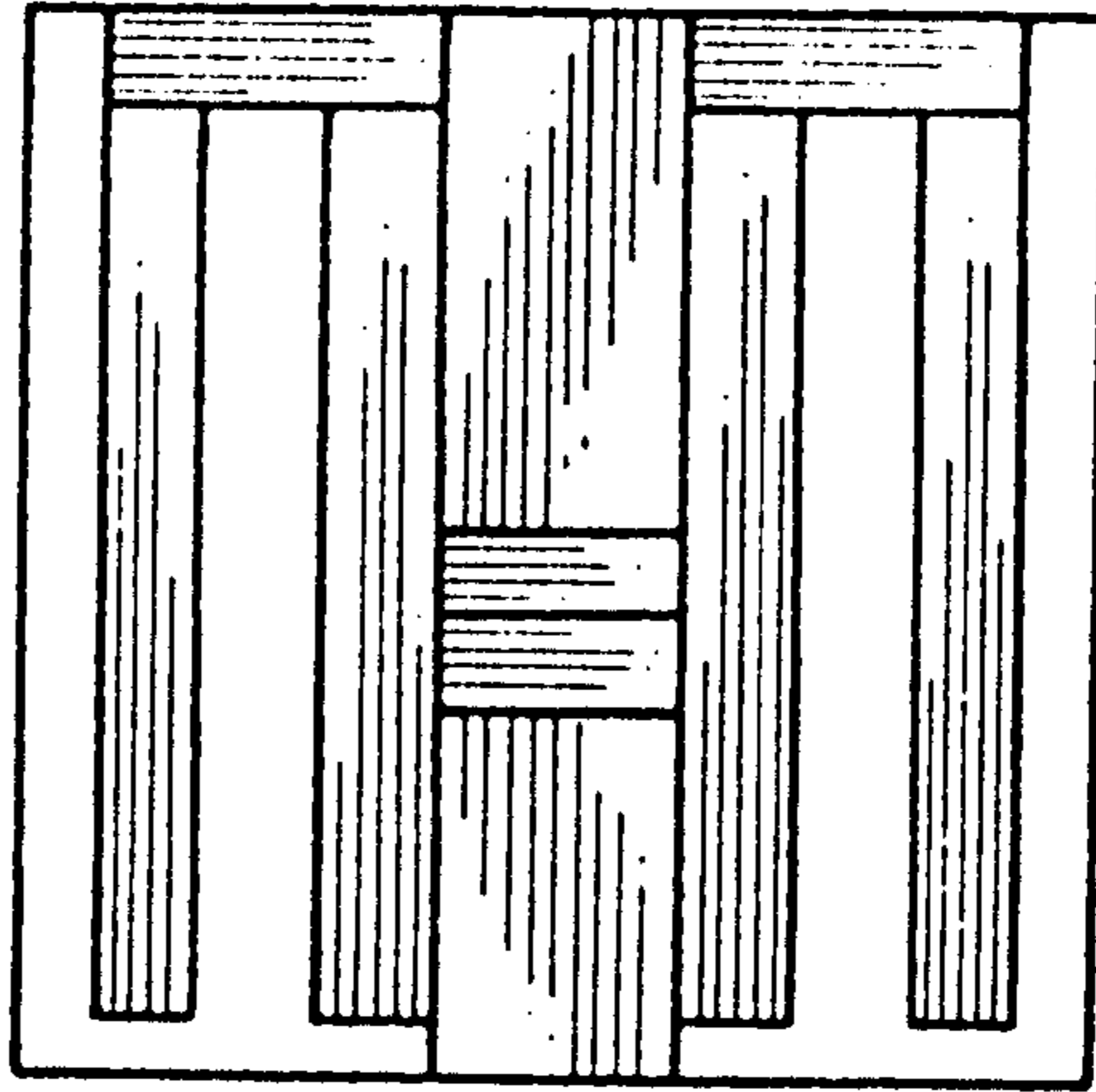

Fig. 2

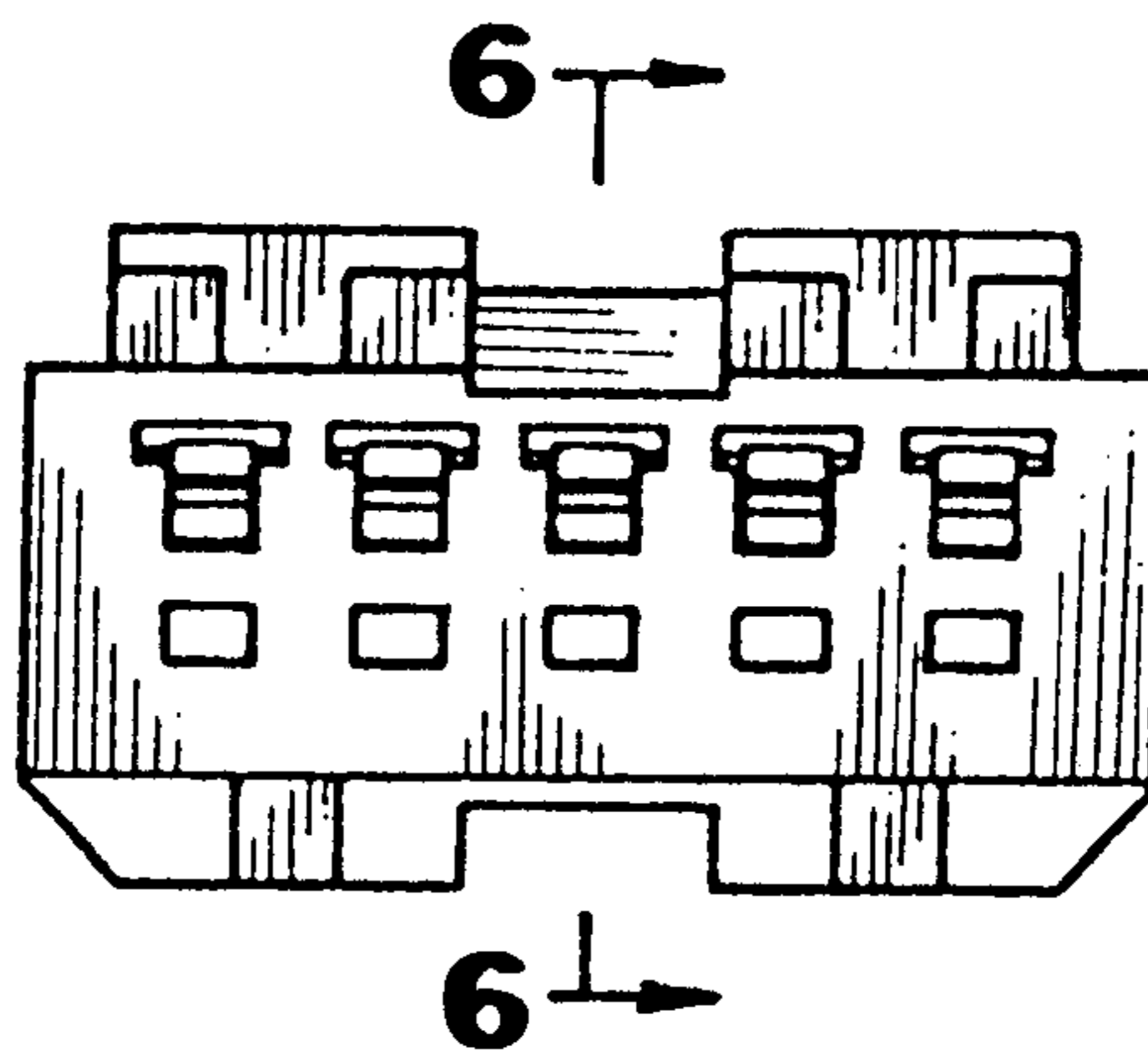

Fig. 3

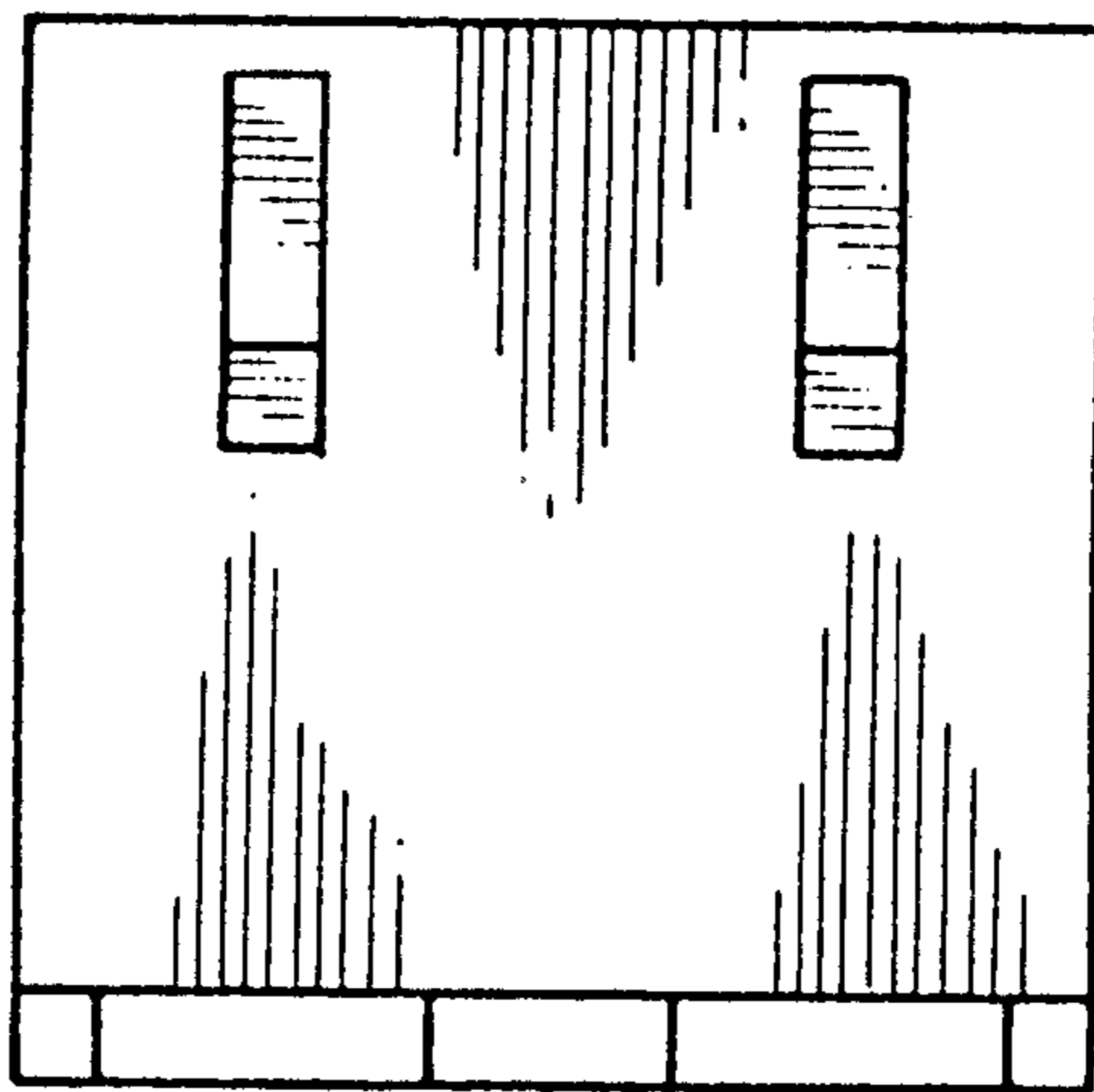

Fig. 4

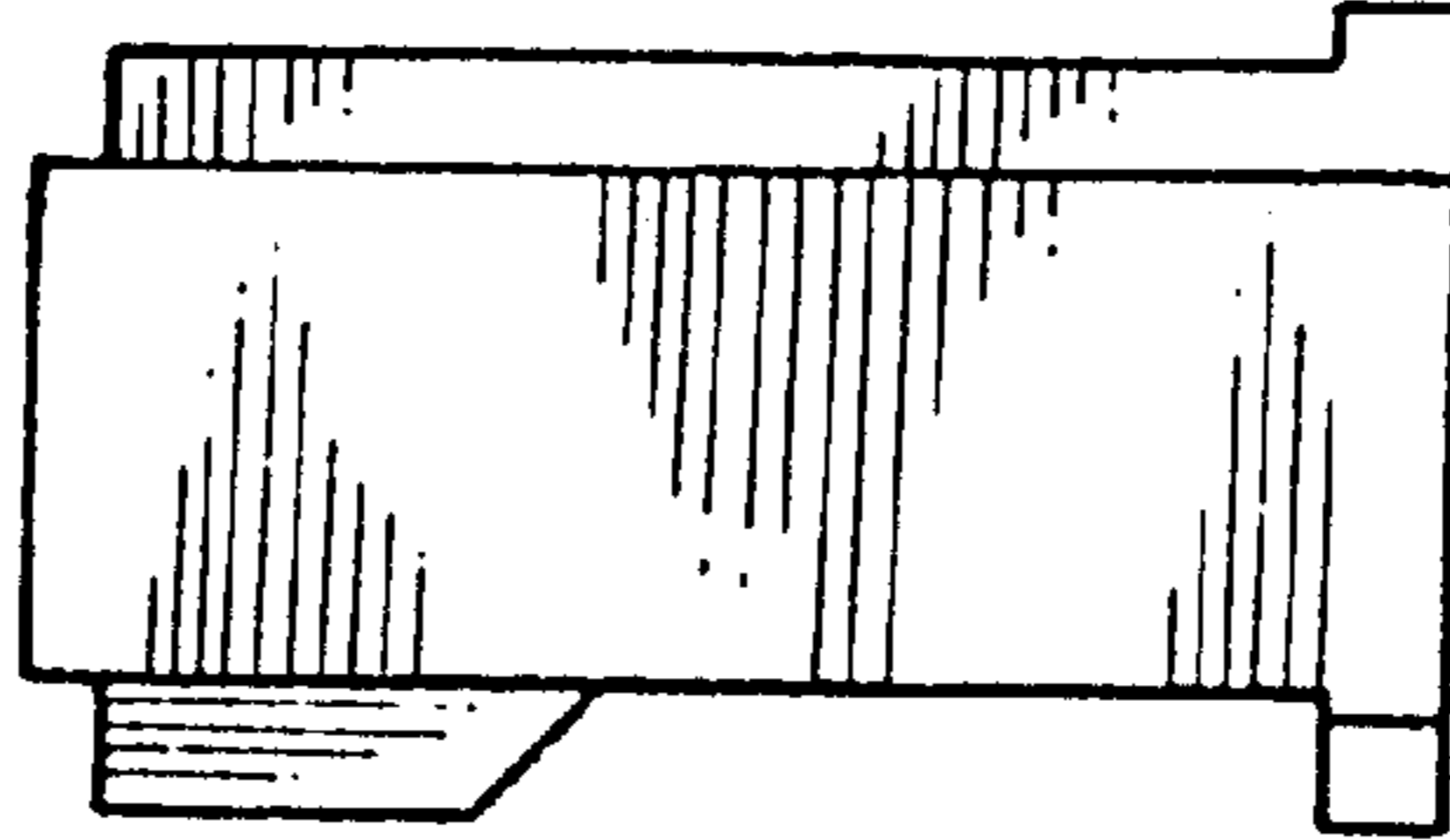

Fig. 5

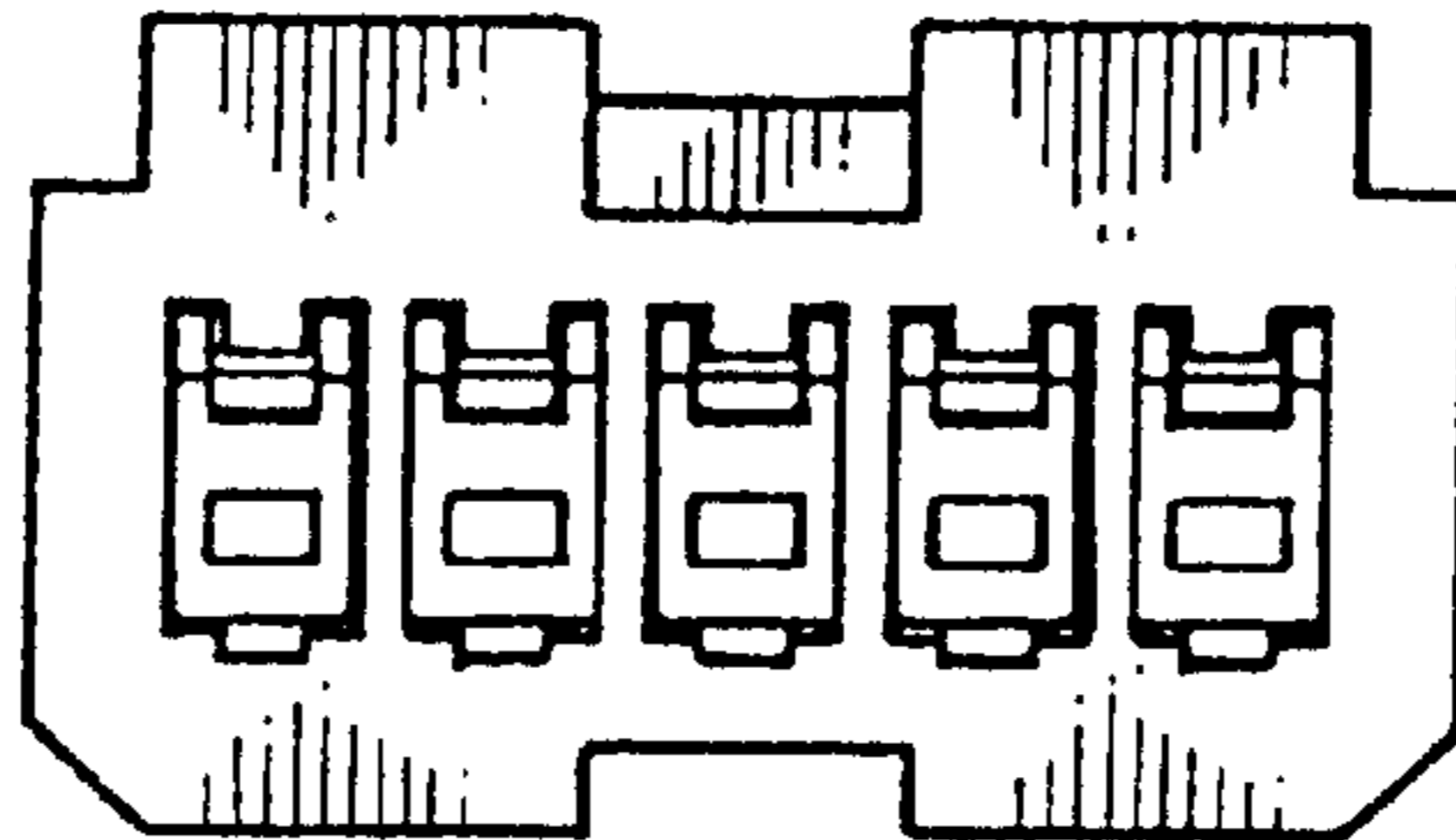

Fig. 6

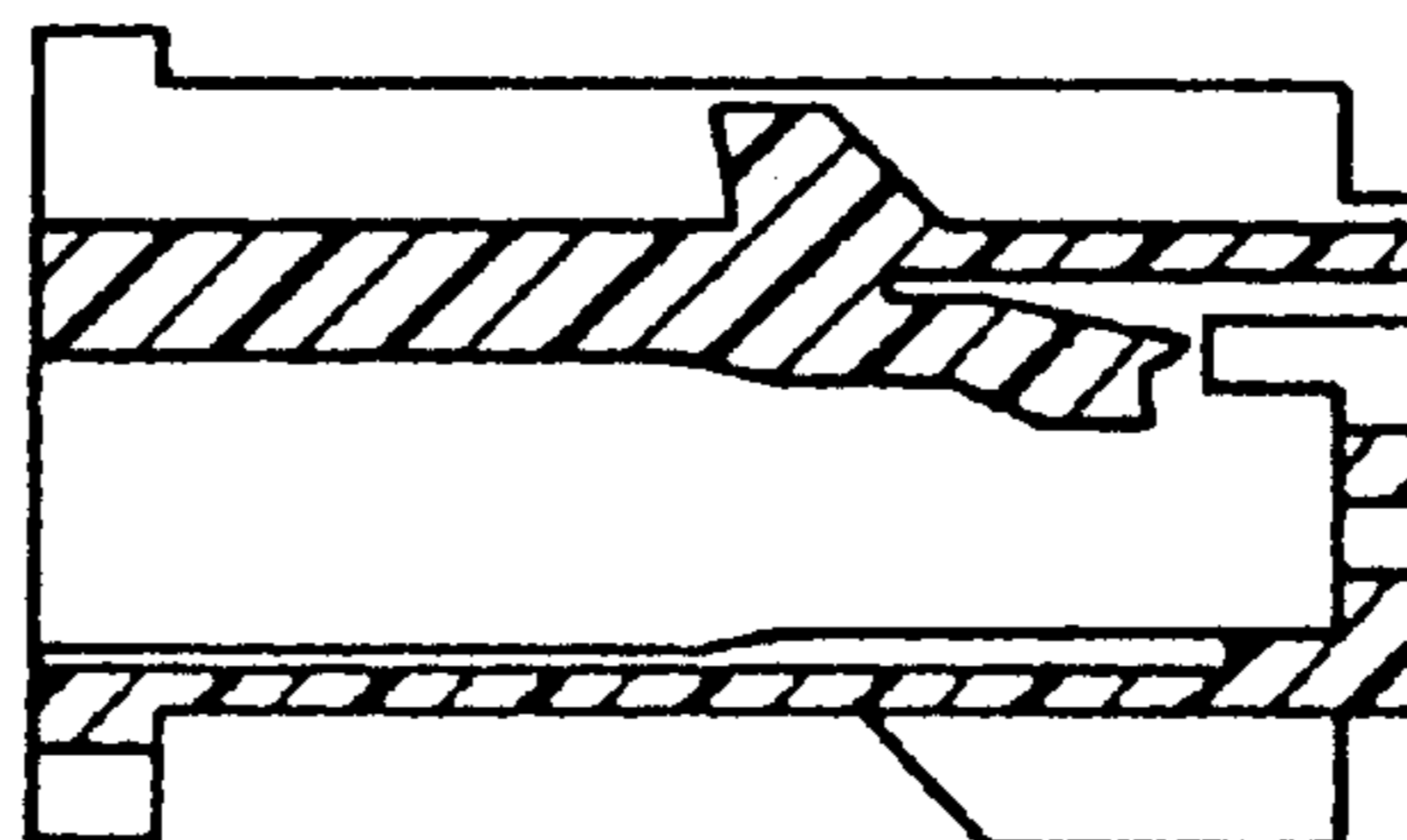

Fig. 7

