



US00D459604S

(12) **United States Design Patent**
Piretti

(10) **Patent No.:** **US D459,604 S**

(45) **Date of Patent:** **** Jul. 2, 2002**

(54) **LOW DENSITY STACK CHAIR**

(75) Inventor: **Giancarlo Piretti**, Bologna (IT)

(73) Assignee: **Pro-Cord S.r.l.**, Bologna (IT)

(**) Term: **14 Years**

(21) Appl. No.: **29/124,676**

(22) Filed: **Jun. 9, 2000**

(51) **LOC (7) Cl.** **06-01**

(52) **U.S. Cl.** **D6/380**

(58) **Field of Search** D6/334, 335, 348,
D6/360, 368, 369, 370, 373, 374, 375,
376, 379, 380, 381, 499, 500, 501, 502,
366; 297/232, 445.1, 446.1, 448.1, 452.63,
452.64, 452.46

(56) **References Cited**

U.S. PATENT DOCUMENTS

D152,895 S	*	3/1949	Lubberts et al.	D6/379
D189,293 S	*	11/1960	Petitt	D6/379
3,343,870 A	*	9/1967	Thatcher et al.	297/452.46
D253,208 S	*	10/1979	Claman	D6/369
D308,143 S		5/1990	Lohmeyer	D6/379
D318,185 S	*	7/1991	Zagaroli et al.	D6/379
D339,006 S	*	9/1993	Schneider	D6/375
D360,083 S		7/1995	Lohmeyer	D6/3
D414,953 S		10/1999	Goetz	D6/379

FOREIGN PATENT DOCUMENTS

WO DM/047 847 7/1998

OTHER PUBLICATIONS

SIDI 2000 Spain, p. 64.*
“VERSA” Brochure CN-02050/PP, Krueger International,
Inc., 1330 Bellevue St., Green Bay, WI 54308-8100, 1990.

* cited by examiner

Primary Examiner—Doris V. Coles

Assistant Examiner—Elizabeth A. Albert

(74) *Attorney, Agent, or Firm*—Boyle, Fredrickson,
Newholm, Stein & Gratz, S.C.

(57) **CLAIM**

The ornamental design for a low density stack chair, as shown and described.

DESCRIPTION

FIG. 1 is an isometric view illustrating a first embodiment of a chair with arms incorporating my new design;
FIG. 2 is a front elevation view thereof;
FIG. 3 is a left side elevation view thereof, the right side elevation view being a mirror image;
FIG. 4 is a rear elevation view thereof;
FIG. 5 is a top plan view thereof;
FIG. 6 is an isometric view illustrating a second embodiment of a low density stack chair without arms incorporating my new design;
FIG. 7 is a front elevation view thereof;
FIG. 8 is a left side elevation view thereof, the right side elevation view being a mirror image;
FIG. 9 is a rear elevation view thereof; and,
FIG. 10 is a top plan view thereof.

1 Claim, 6 Drawing Sheets

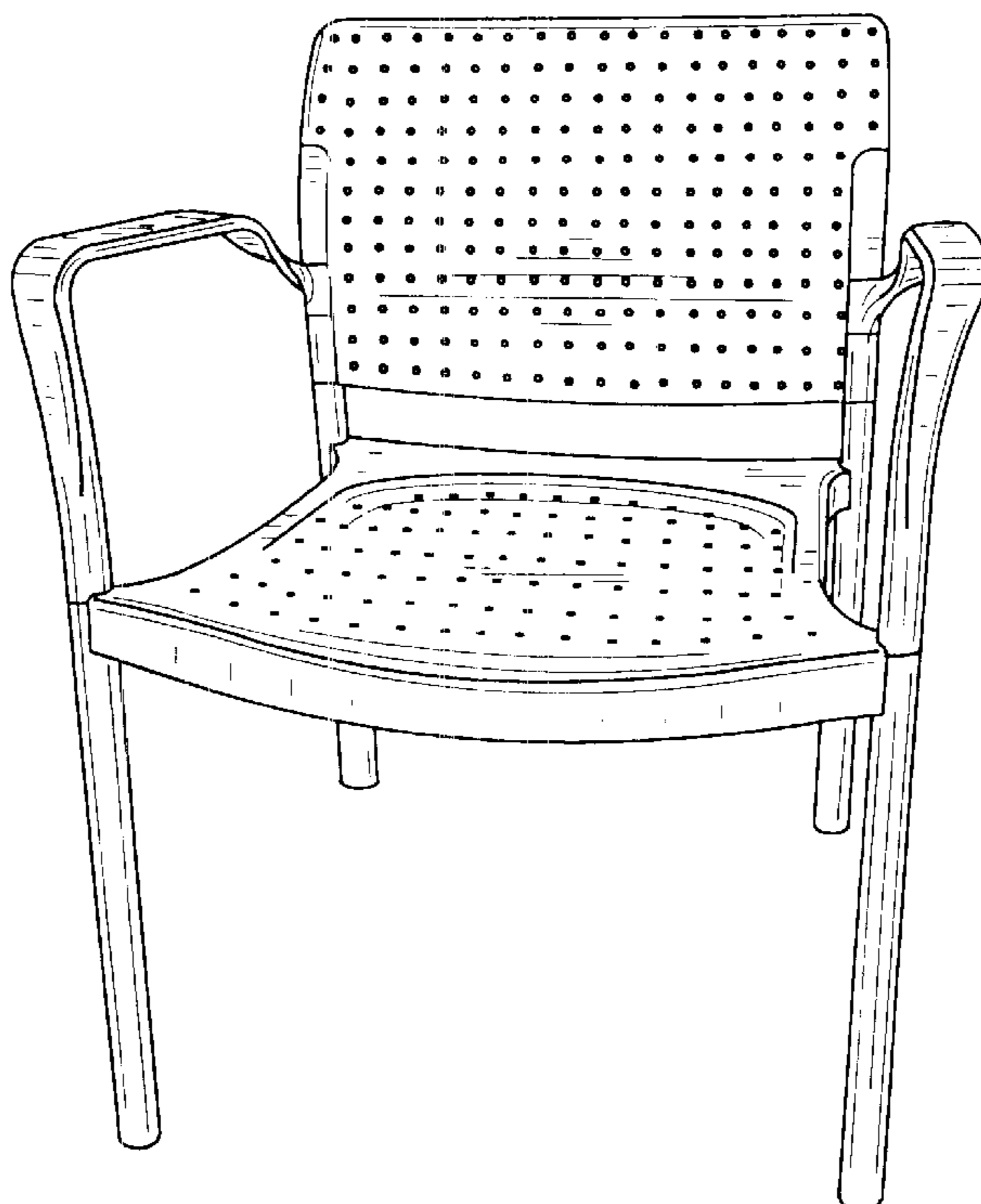

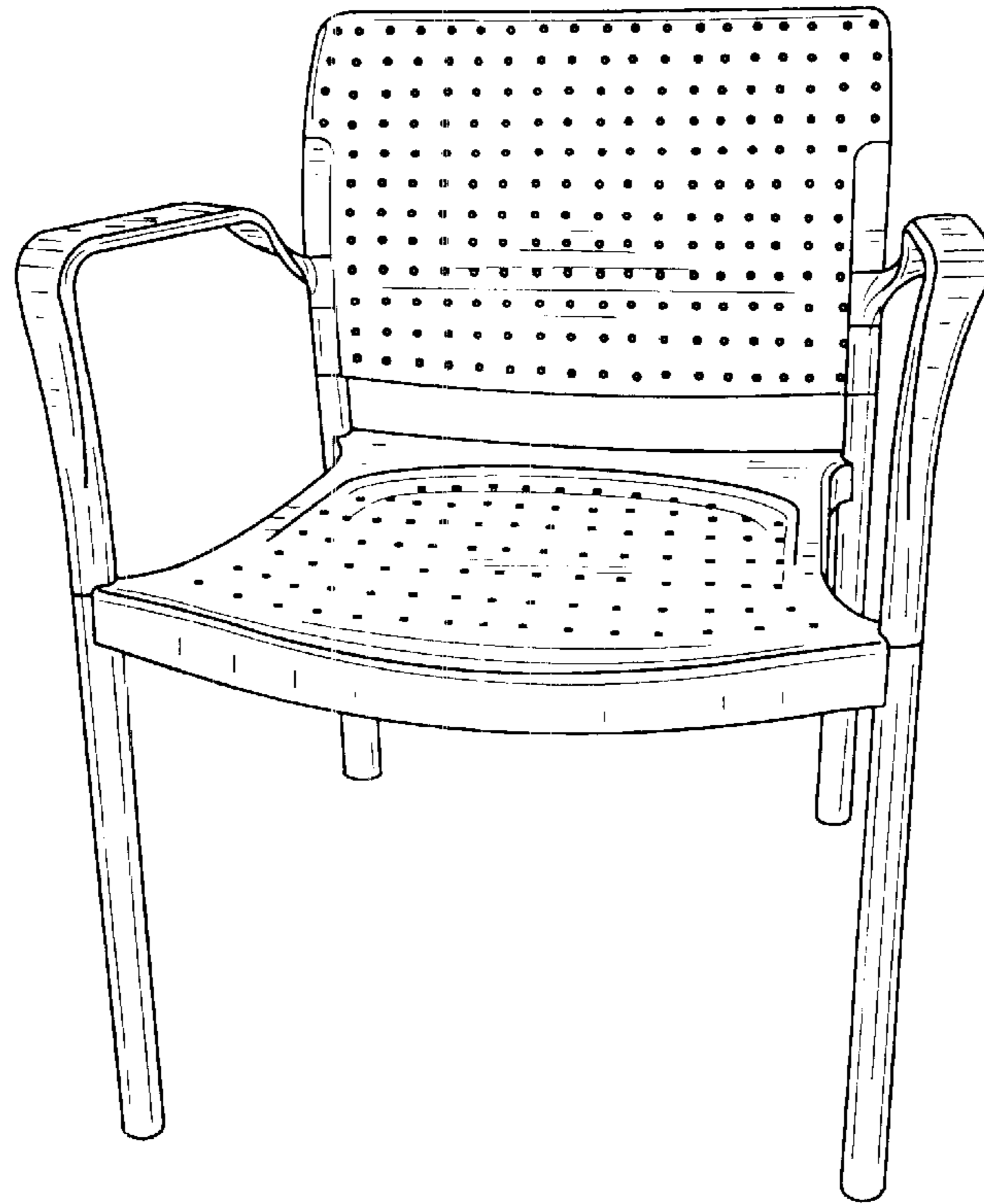

FIG. 1

FIG. 2

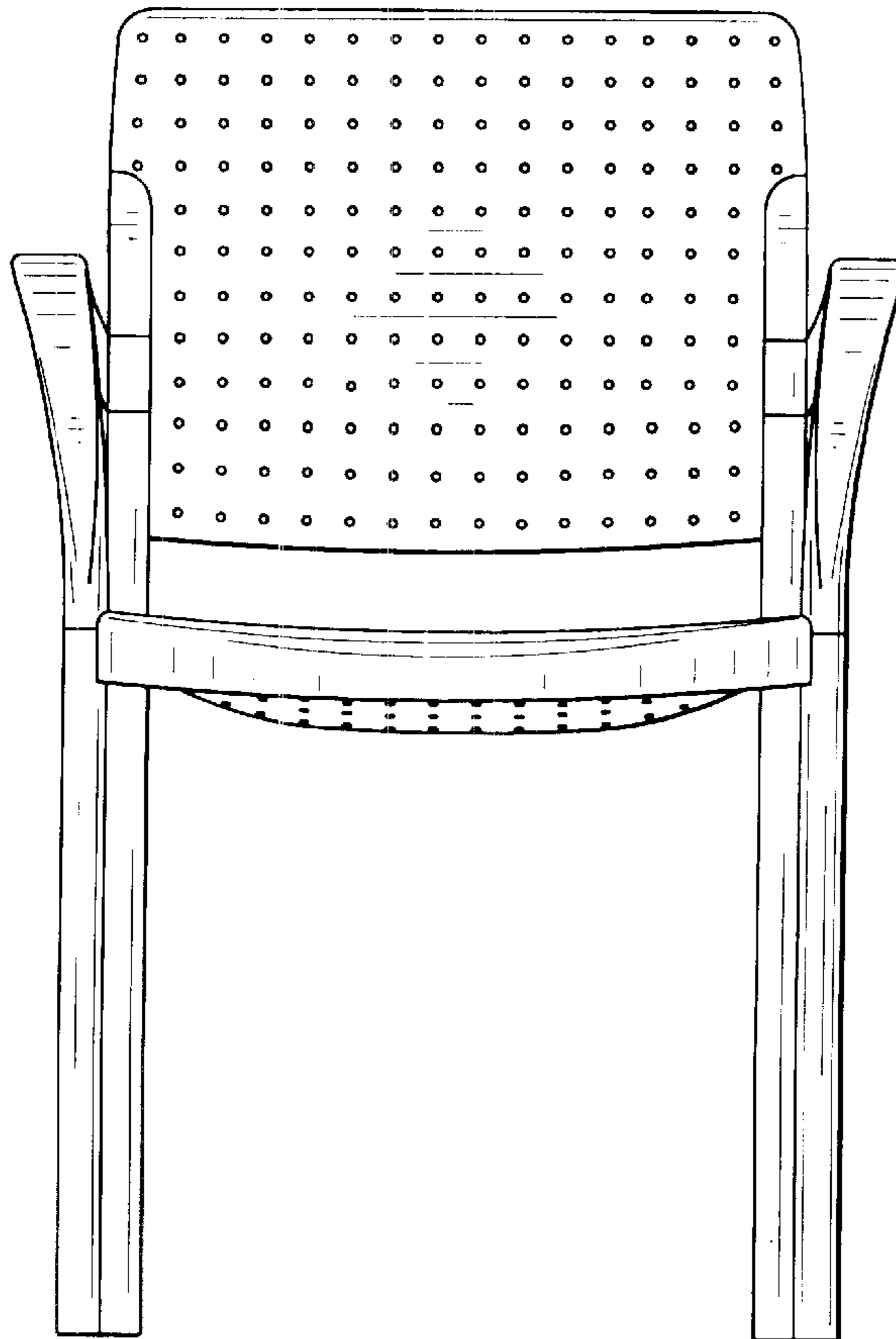
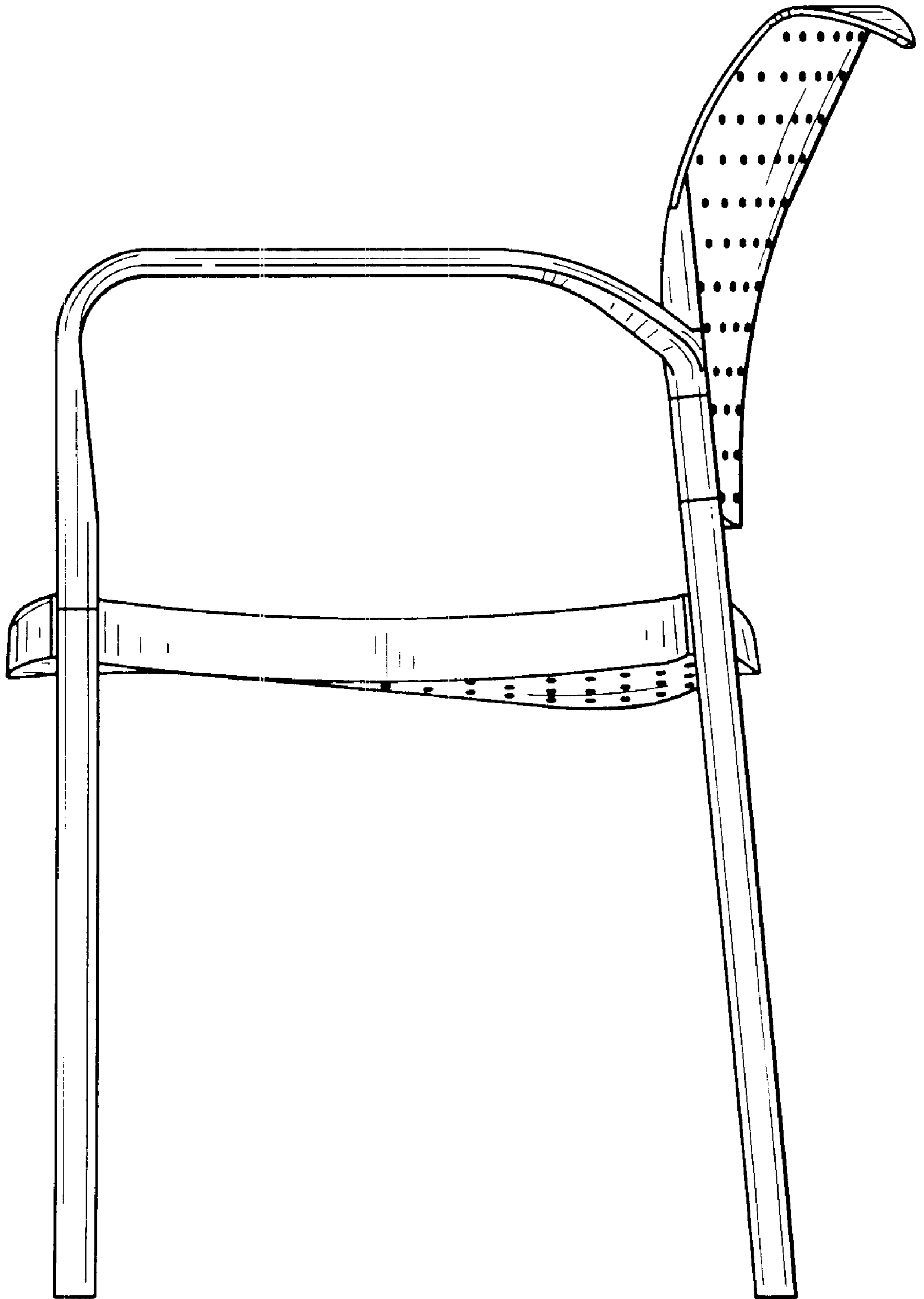

FIG. 3



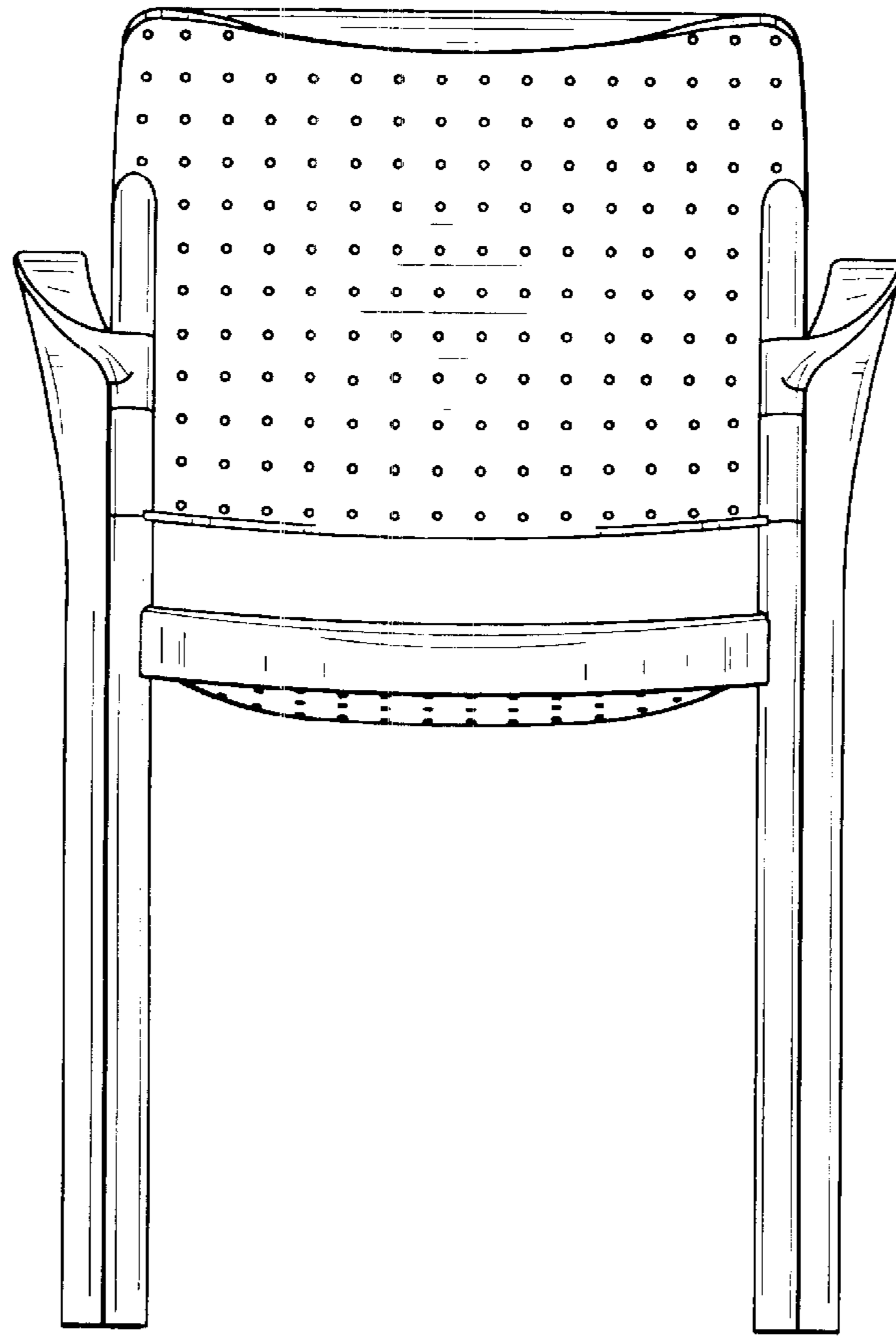
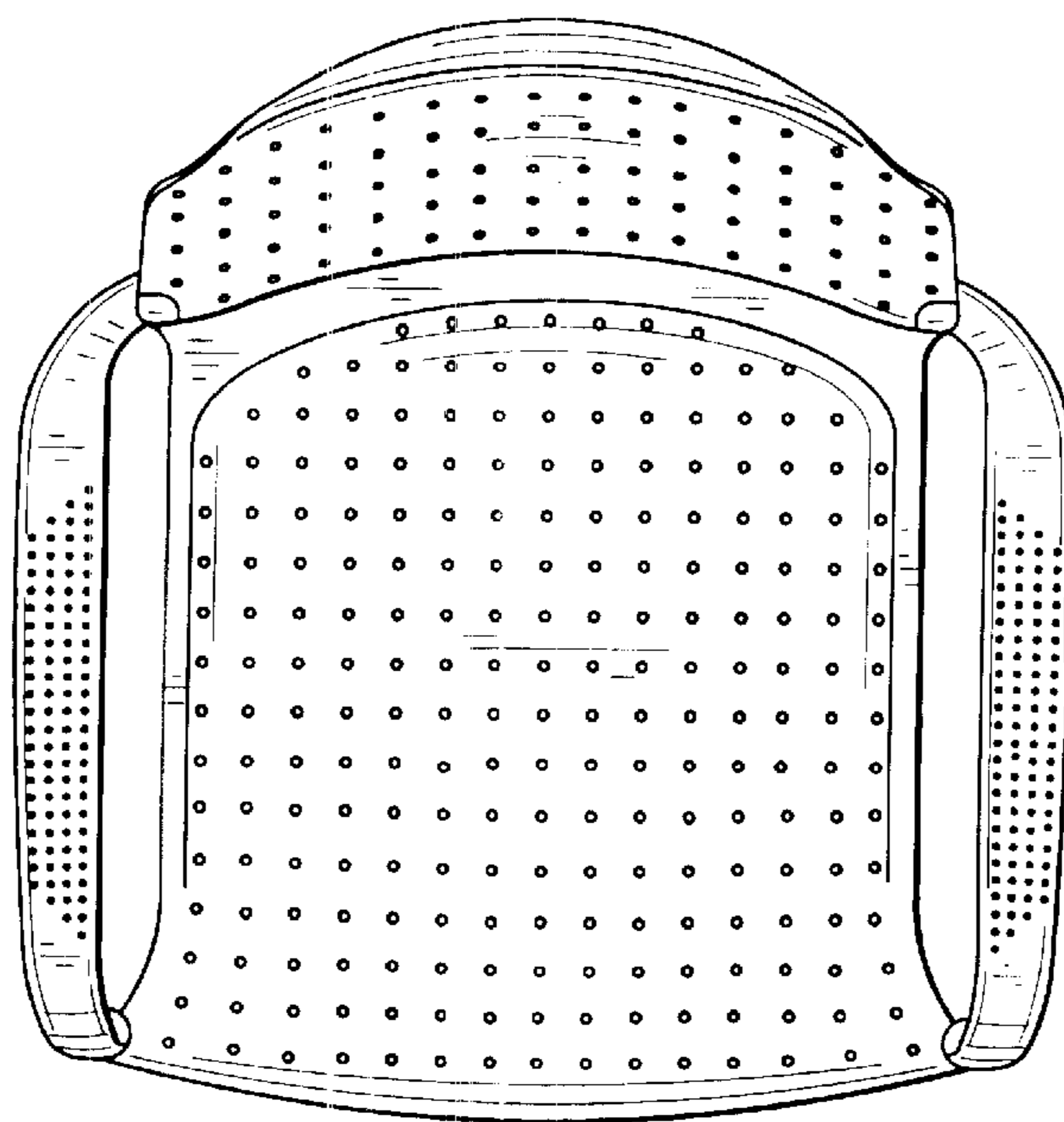

FIG. 4

FIG. 5



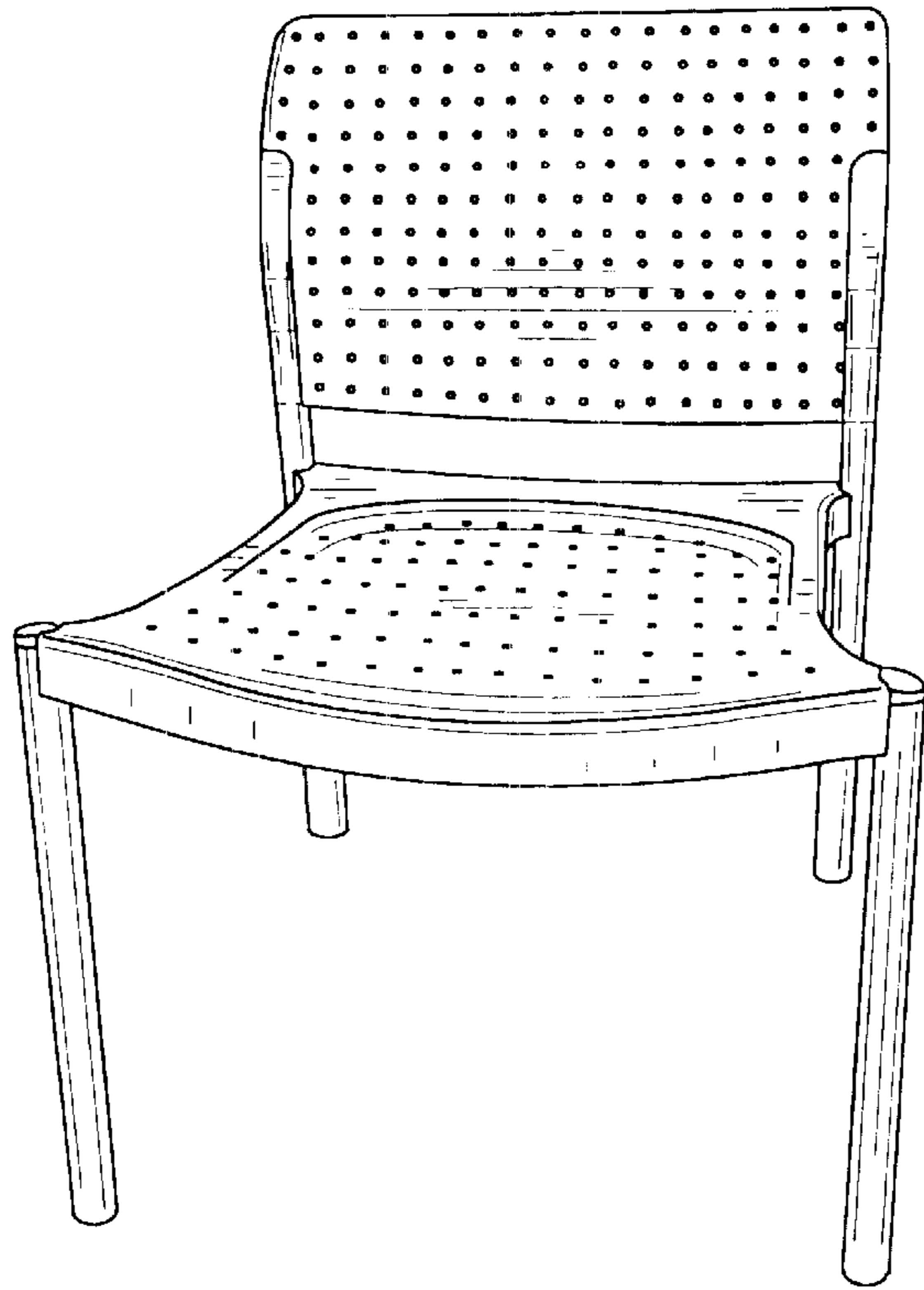

FIG. 6

FIG. 7

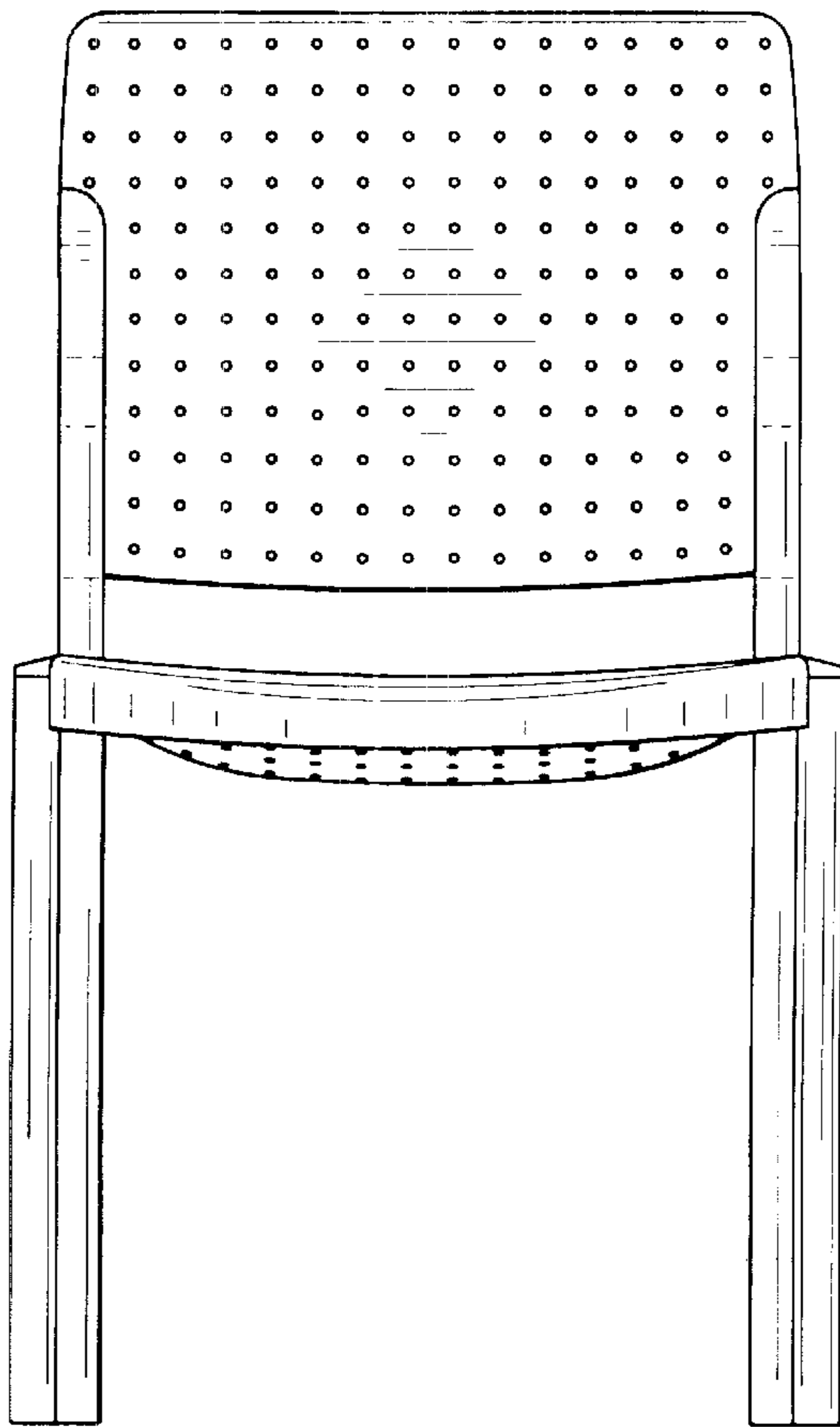
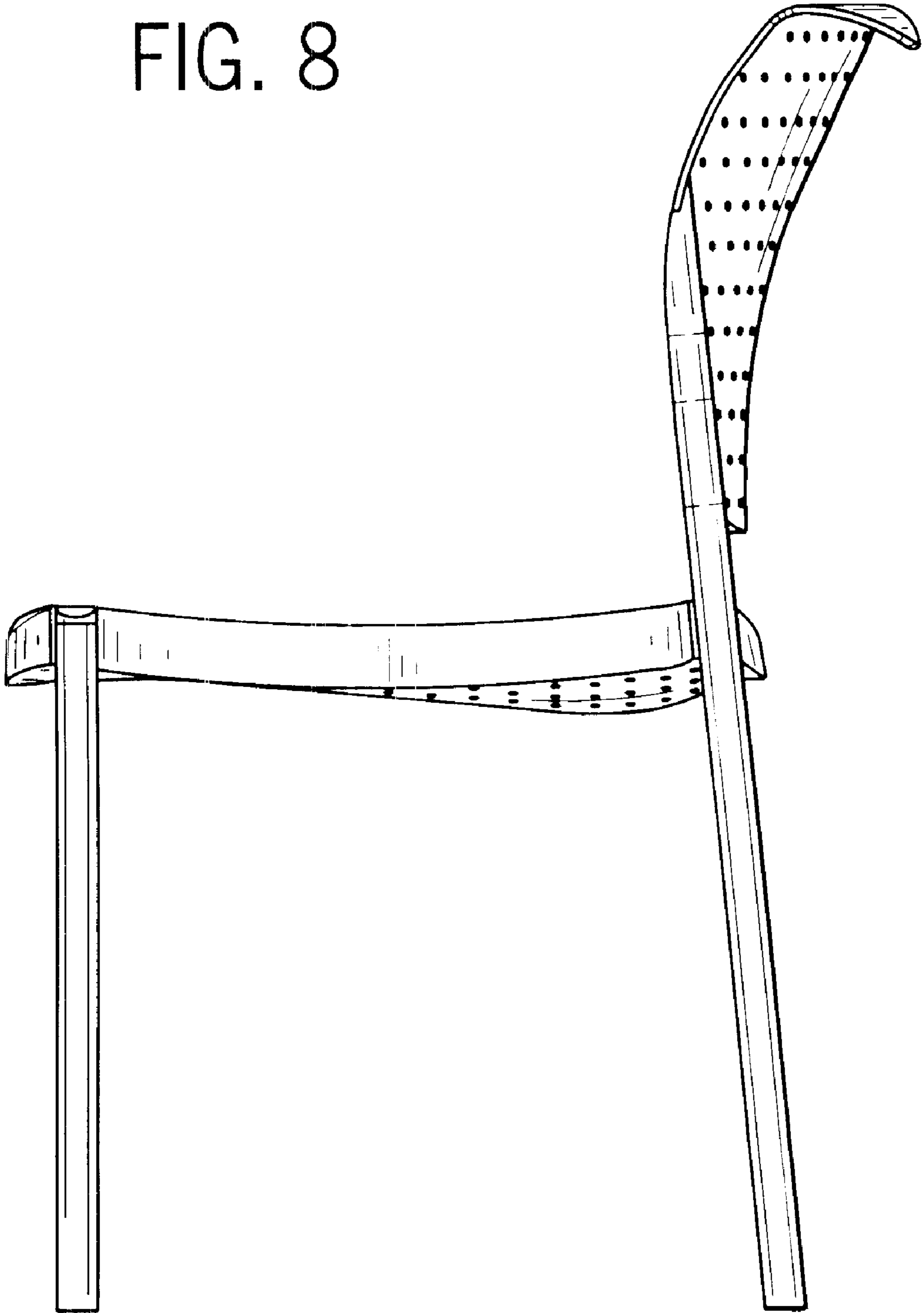

FIG. 8



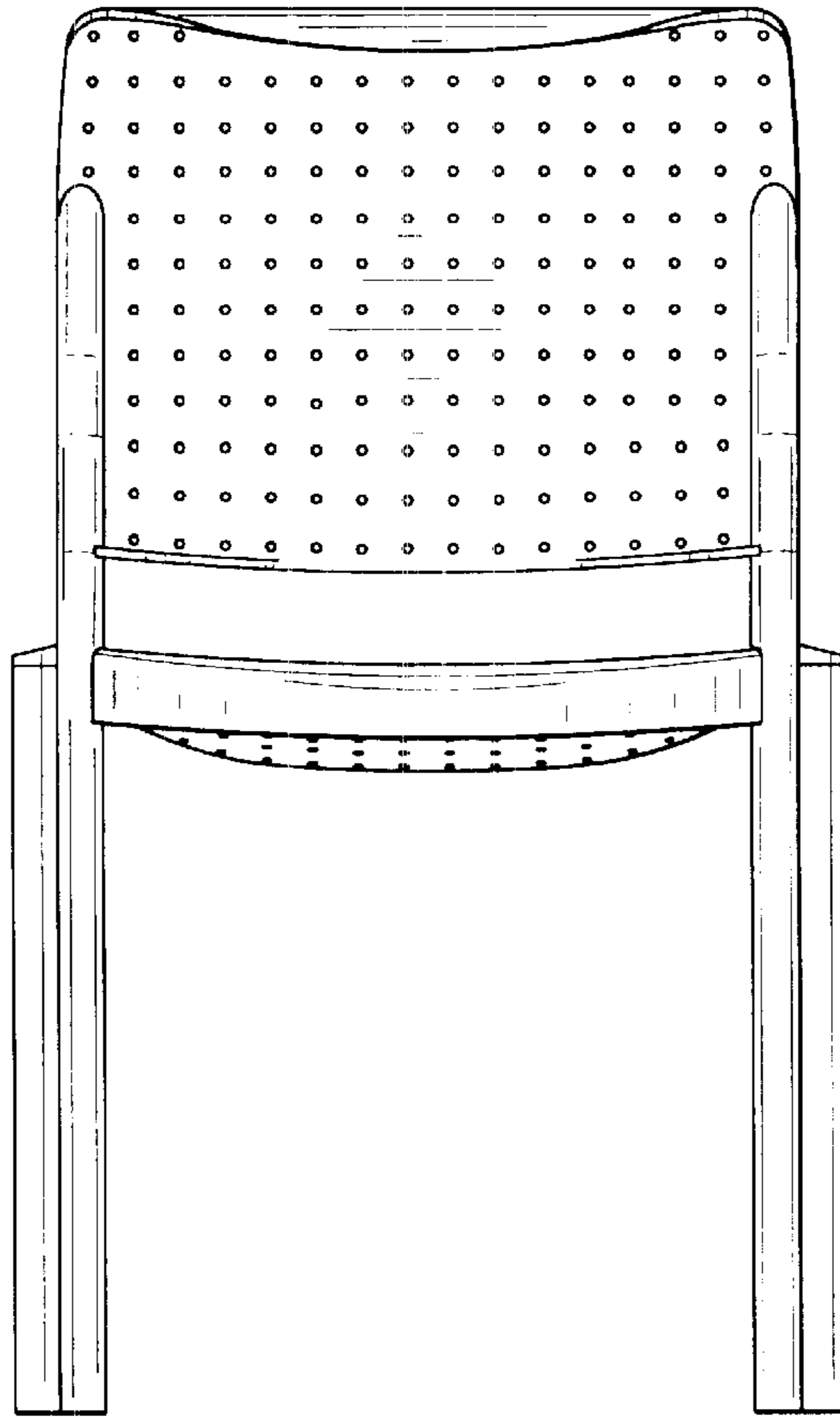

FIG. 9

FIG. 10

