



US00D459481S

(12) **United States Design Patent**  
**Levin**

(10) **Patent No.:** **US D459,481 S**

(45) **Date of Patent:** **\*\* \*Jun. 25, 2002**

(54) **WARMER FOR MEDICAL PADS**

(76) **Inventor:** **Andrew Levin**, 4450 NE. Indian River Dr., Jensen Beach, FL (US) 34951

(\* ) **Notice:** This patent is subject to a terminal disclaimer.

(\*\* ) **Term:** **14 Years**

(21) **Appl. No.:** **29/128,254**

(22) **Filed:** **Aug. 22, 2000**

(51) **LOC (7) Cl.** ..... **24-04**

(52) **U.S. Cl.** ..... **D24/232**

(58) **Field of Search** ..... D24/206, 217, D24/232, 231; 607/104, 105; D23/314; 219/200, 521, 528, 201, 428, 451.1, 453.11, 526, 527, 537, 538

(56) **References Cited**

**U.S. PATENT DOCUMENTS**

- 3,345,497 A \* 10/1967 Porteous ..... 219/428
- 4,665,309 A \* 5/1987 Derbyshire ..... 219/551

- D299,048 S \* 12/1988 Bankston ..... D24/216
- 5,399,840 A \* 3/1995 Goeddeke ..... 219/521
- D362,493 S \* 9/1995 Begum ..... D23/314
- D390,645 S \* 2/1998 Hanrahan et al. .... D23/314

\* cited by examiner

*Primary Examiner*—Ian Simmons

(74) *Attorney, Agent, or Firm*—Kevin Redmond

(57) **CLAIM**

The ornamental design for a warmer for medical pads, as shown and described.

**DESCRIPTION**

FIG. 1 is a exploded perspective view of a warmer for medical pads showing my new design, the broken line showing is for illustrative purposes only and forms no part of the claimed design;

FIG. 2 is a side elevational view thereof;

FIG. 3 is a front elevational view thereof;

FIG. 4 is a top plan view thereof; and,

FIG. 5 is a bottom plan view thereof.

**1 Claim, 3 Drawing Sheets**

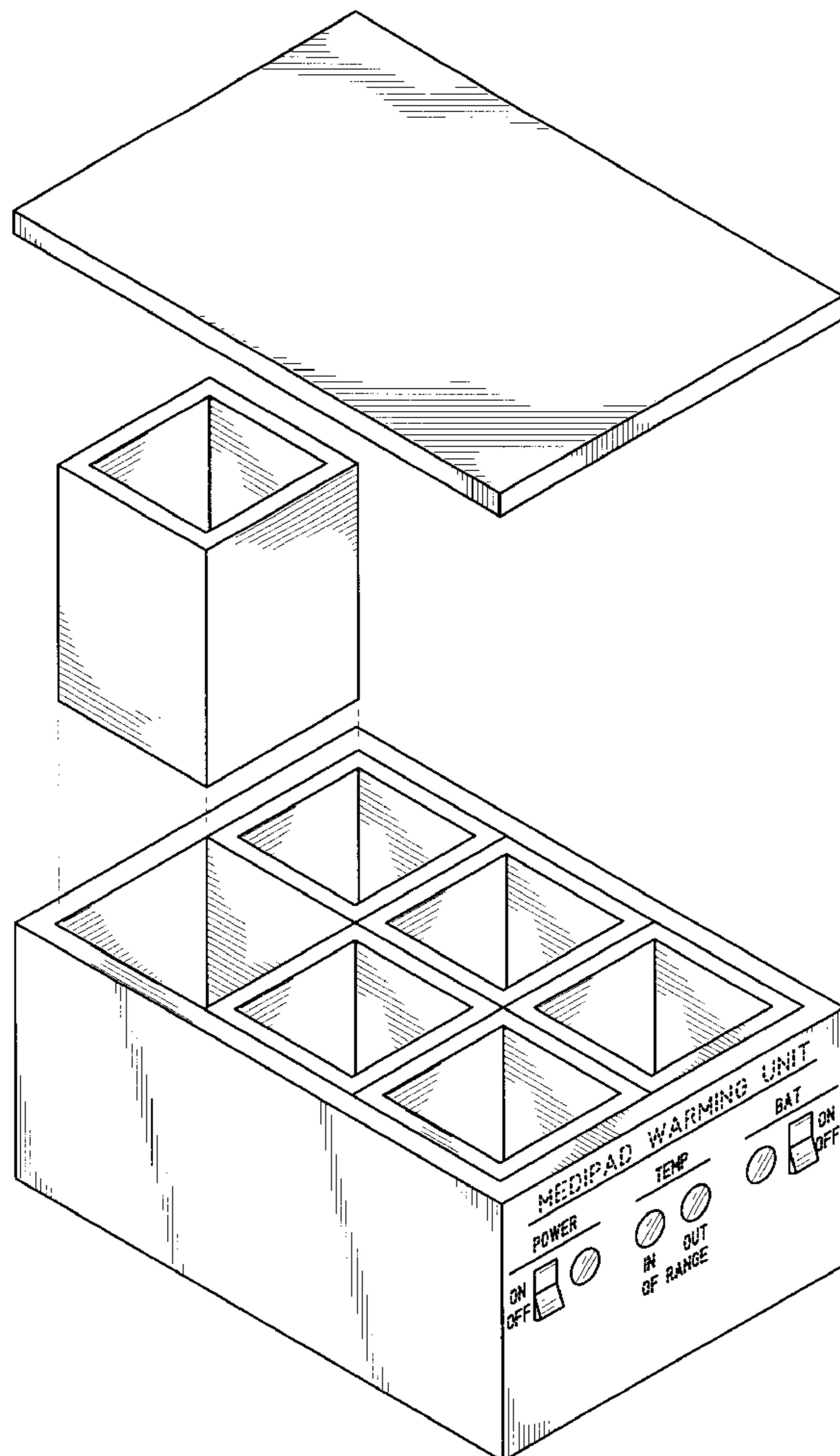

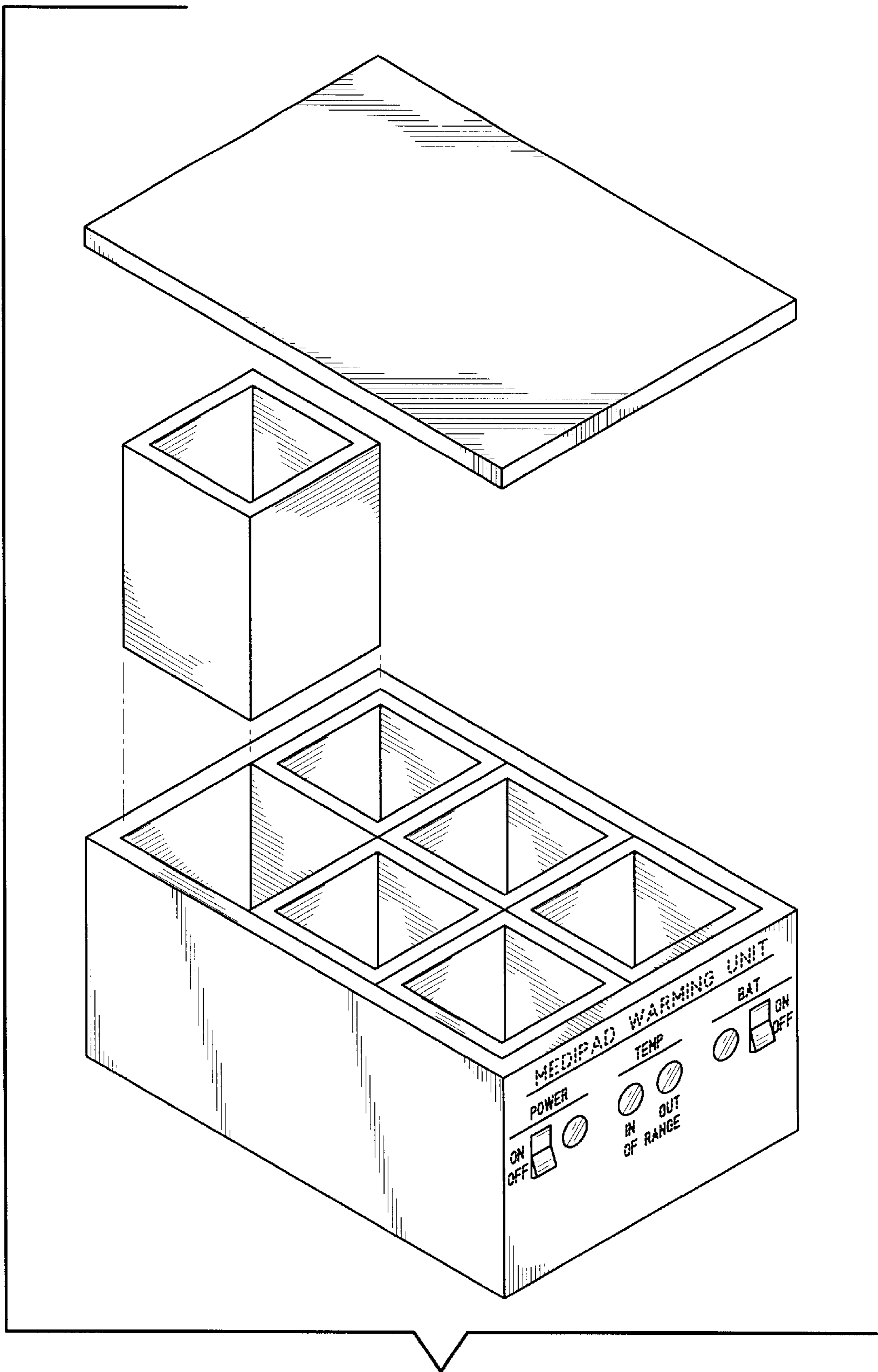

Fig. 1

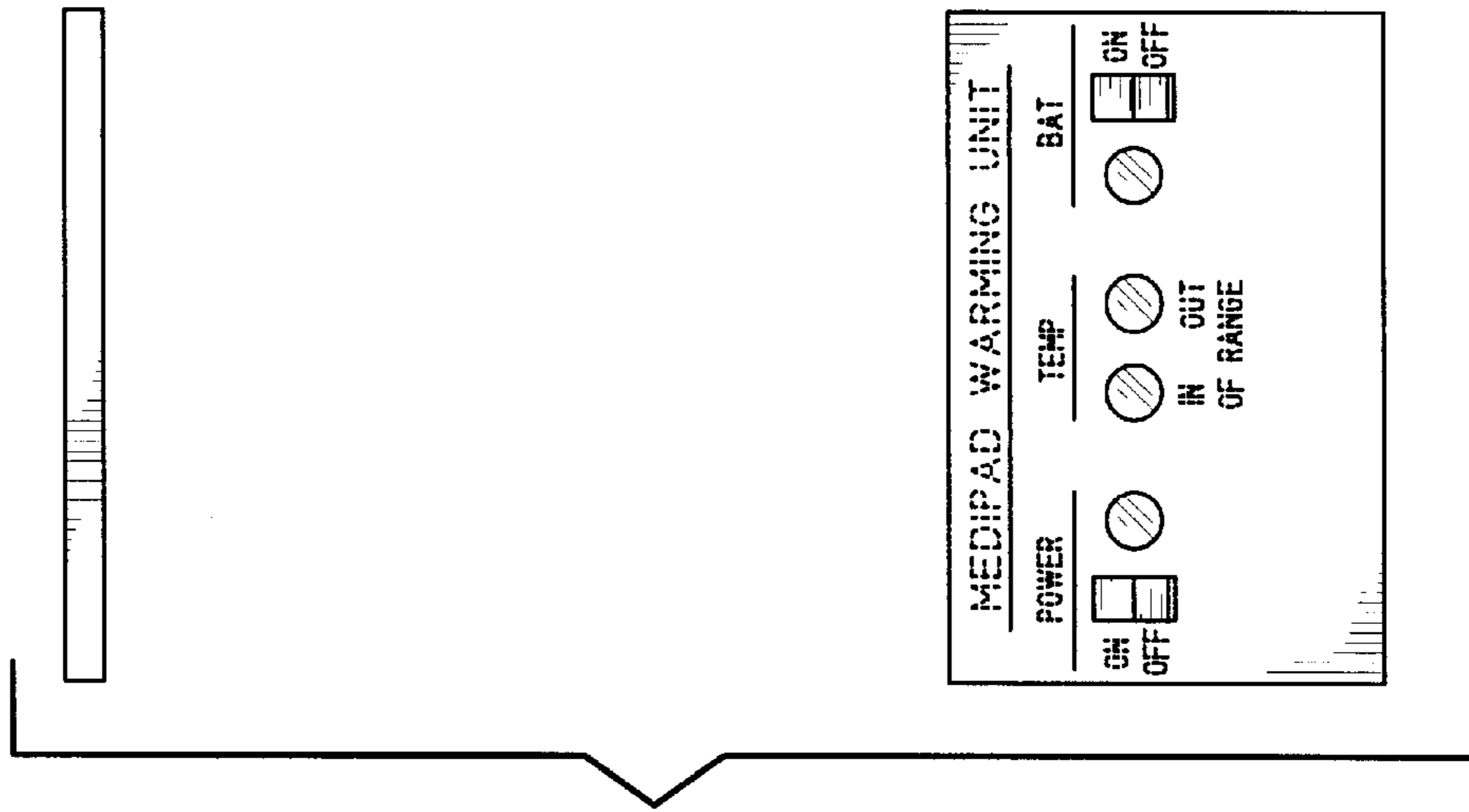

Fig. 2

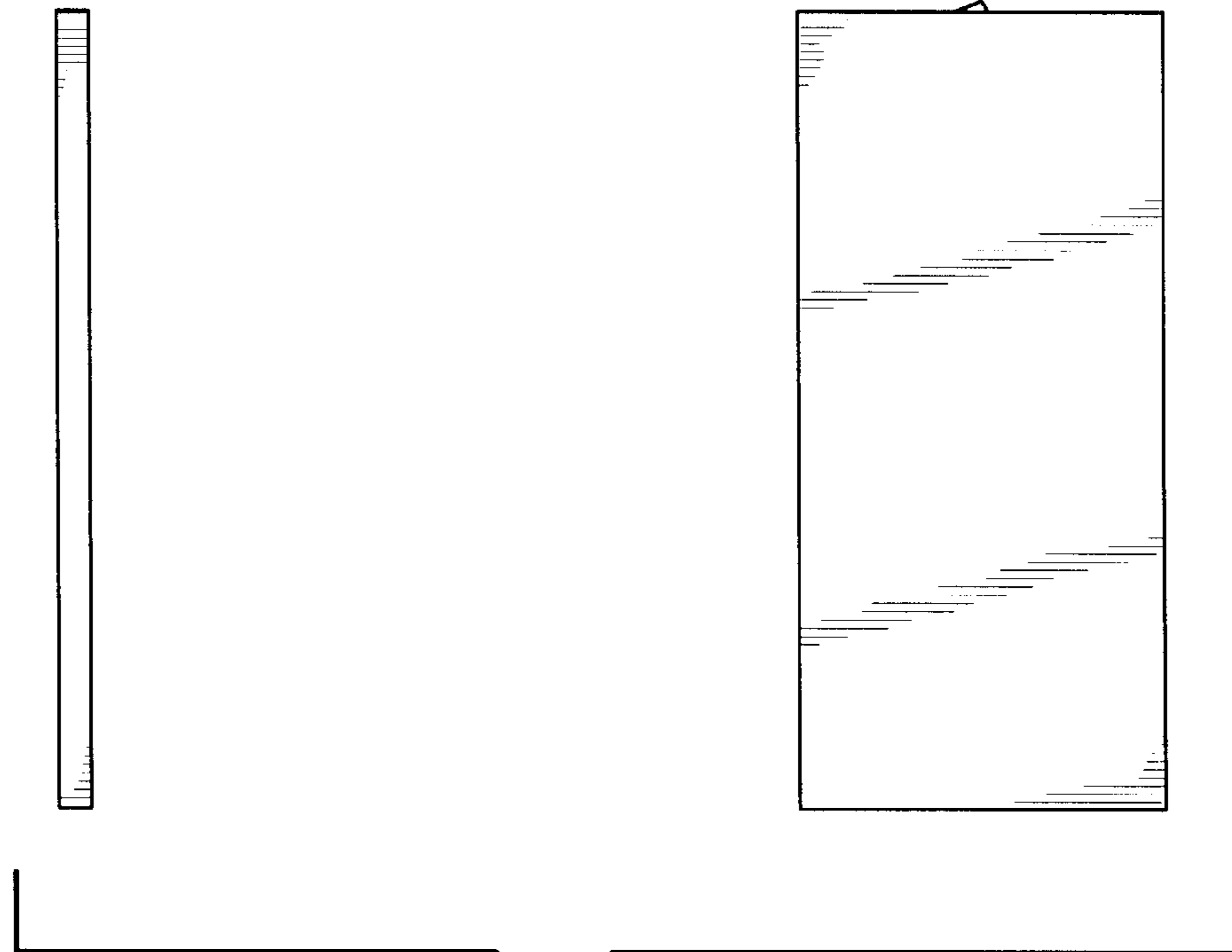
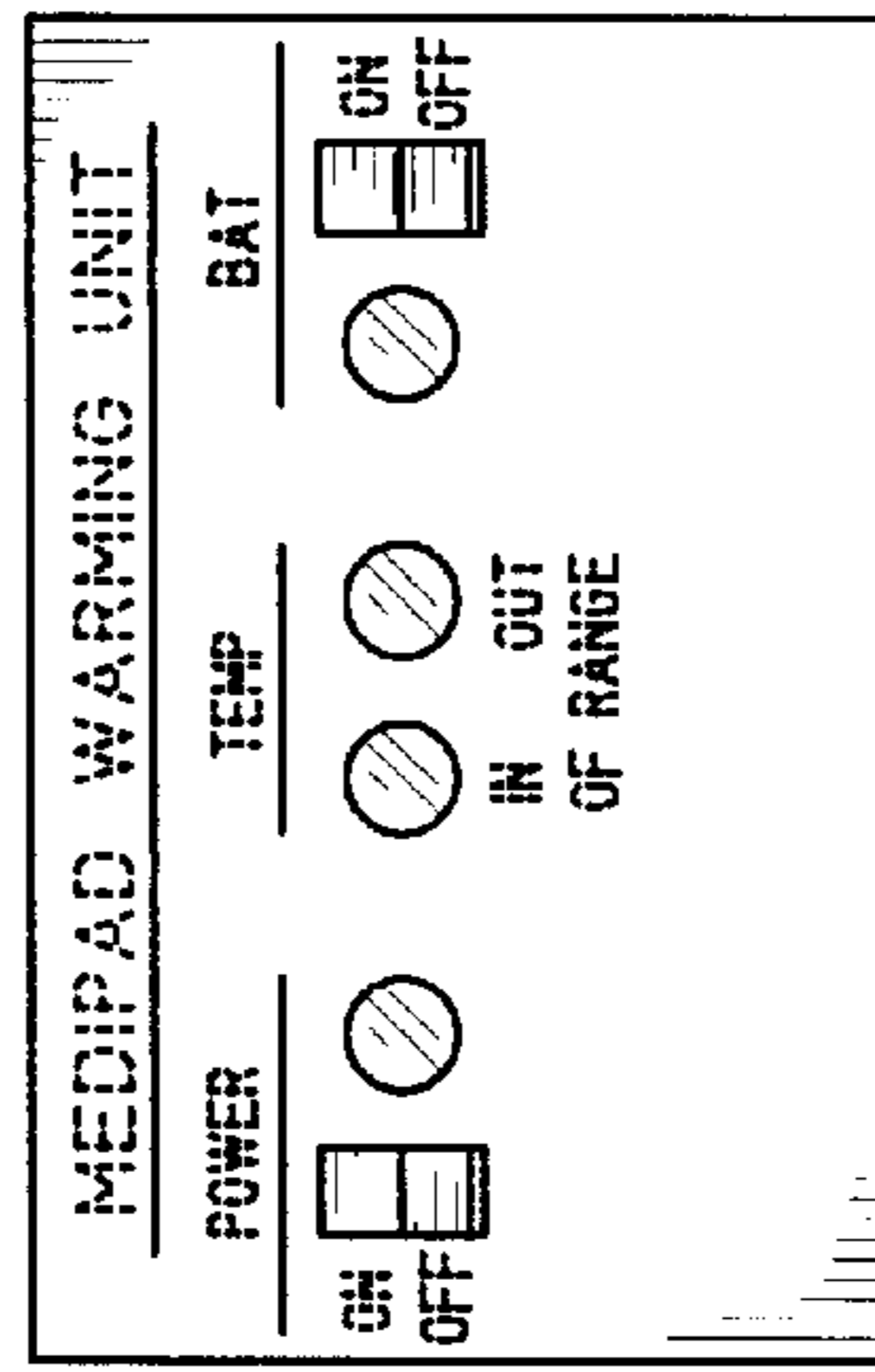
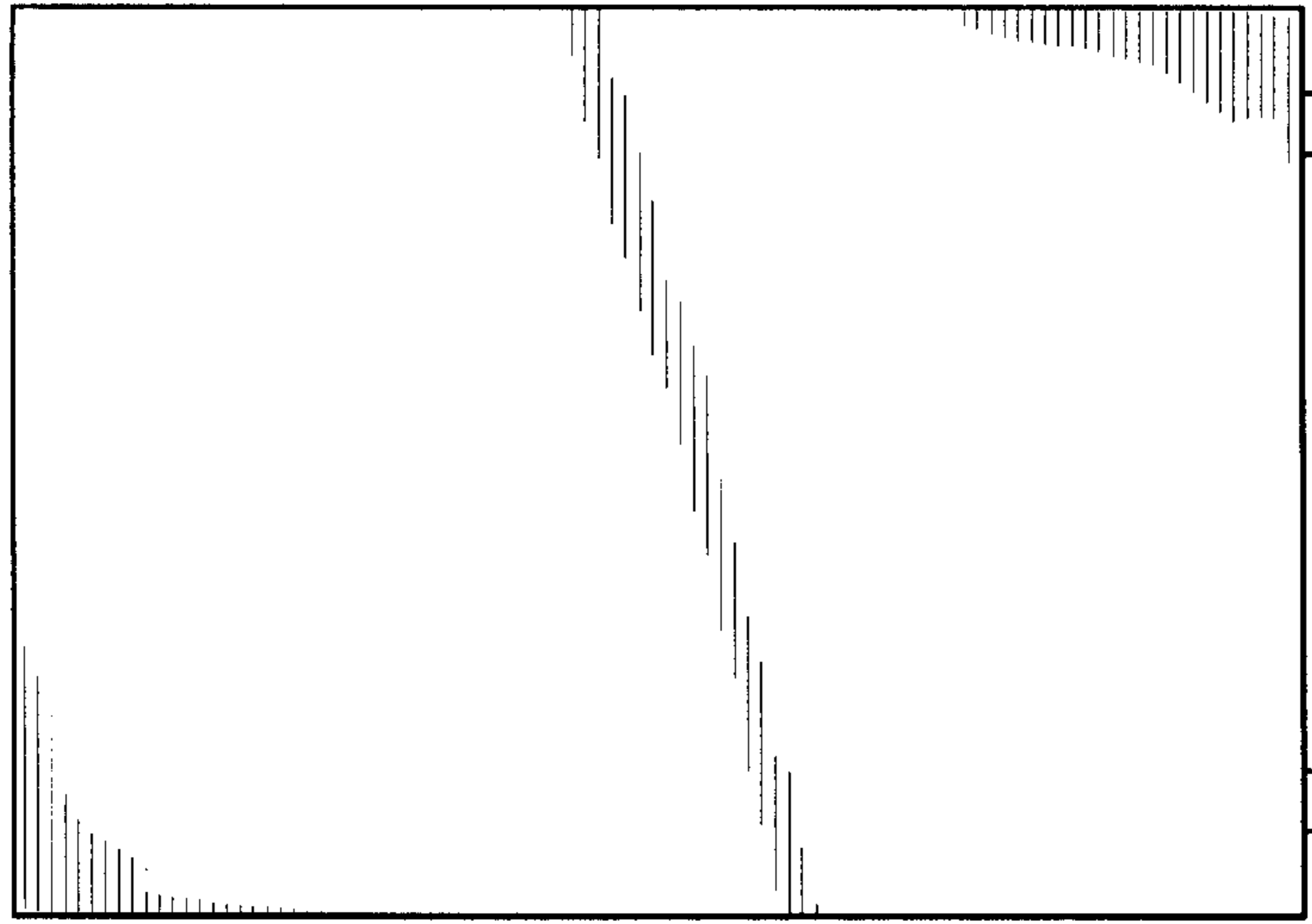
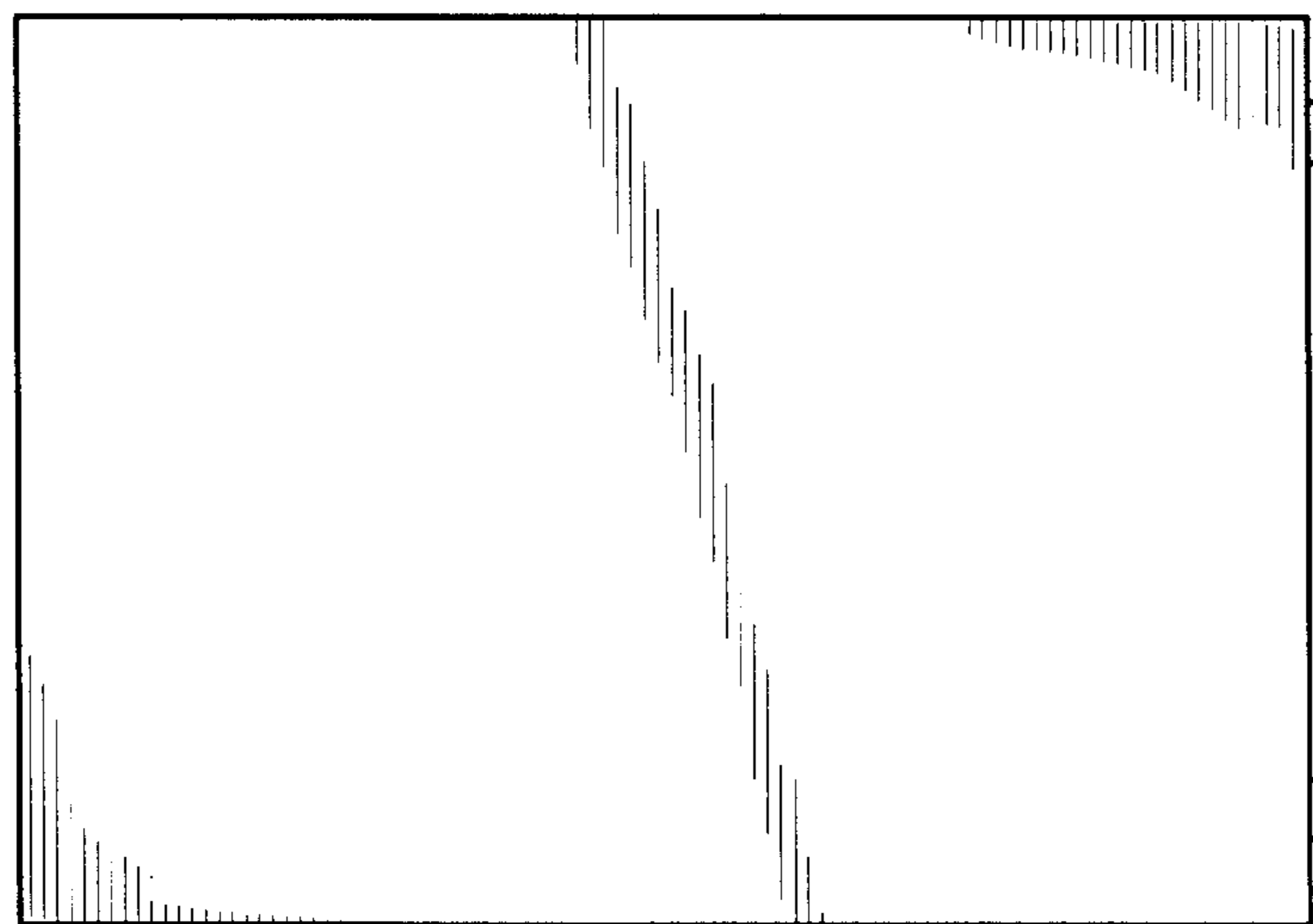

Fig. 3





*Fig. 4*



*Fig. 5*