



US00D459456S

(12) **United States Design Patent**
Campbell

(10) **Patent No.:** **US D459,456 S**

(45) **Date of Patent:** **** Jun. 25, 2002**

(54) **HUMIDIFIER**

(75) **Inventor:** **Glennbruce S. Campbell**, Memphis, TN (US)

(73) **Assignee:** **Hunter Fan Company**, Memphis, TN (US)

(**) **Term:** **14 Years**

(21) **Appl. No.:** **29/150,518**

(22) **Filed:** **Nov. 19, 2001**

(51) **LOC (7) Cl.** **23-04**

(52) **U.S. Cl.** **D23/356**

(58) **Field of Search** D23/356-363;
261/107; 422/120, 123; 392/403-406, 394

(56) **References Cited**

U.S. PATENT DOCUMENTS

D330,074 S	*	10/1992	Wang et al.	D23/356
D394,099 S	*	5/1998	Tsuji	D23/356
D411,000 S	*	6/1999	Moore	D23/356

* cited by examiner

Primary Examiner—Lisa Lichtenstein

(74) *Attorney, Agent, or Firm*—Baker, Donelson, Bearman & Caldwell

(57) **CLAIM**

The ornamental design for a humidifier, as shown and described.

DESCRIPTION

FIG. 1 is a perspective view of a humidifier showing my new design.

FIG. 2 is a front view thereof.

FIG. 3 is a rear view thereof.

FIG. 4 is a left side view thereof.

FIG. 5 is a right side view thereof.

FIG. 6 is a top view thereof; and,

FIG. 7 is a bottom view thereof.

The broken lines in the views show features which are for illustrative purposes only and form no part of the claimed design.

1 Claim, 4 Drawing Sheets

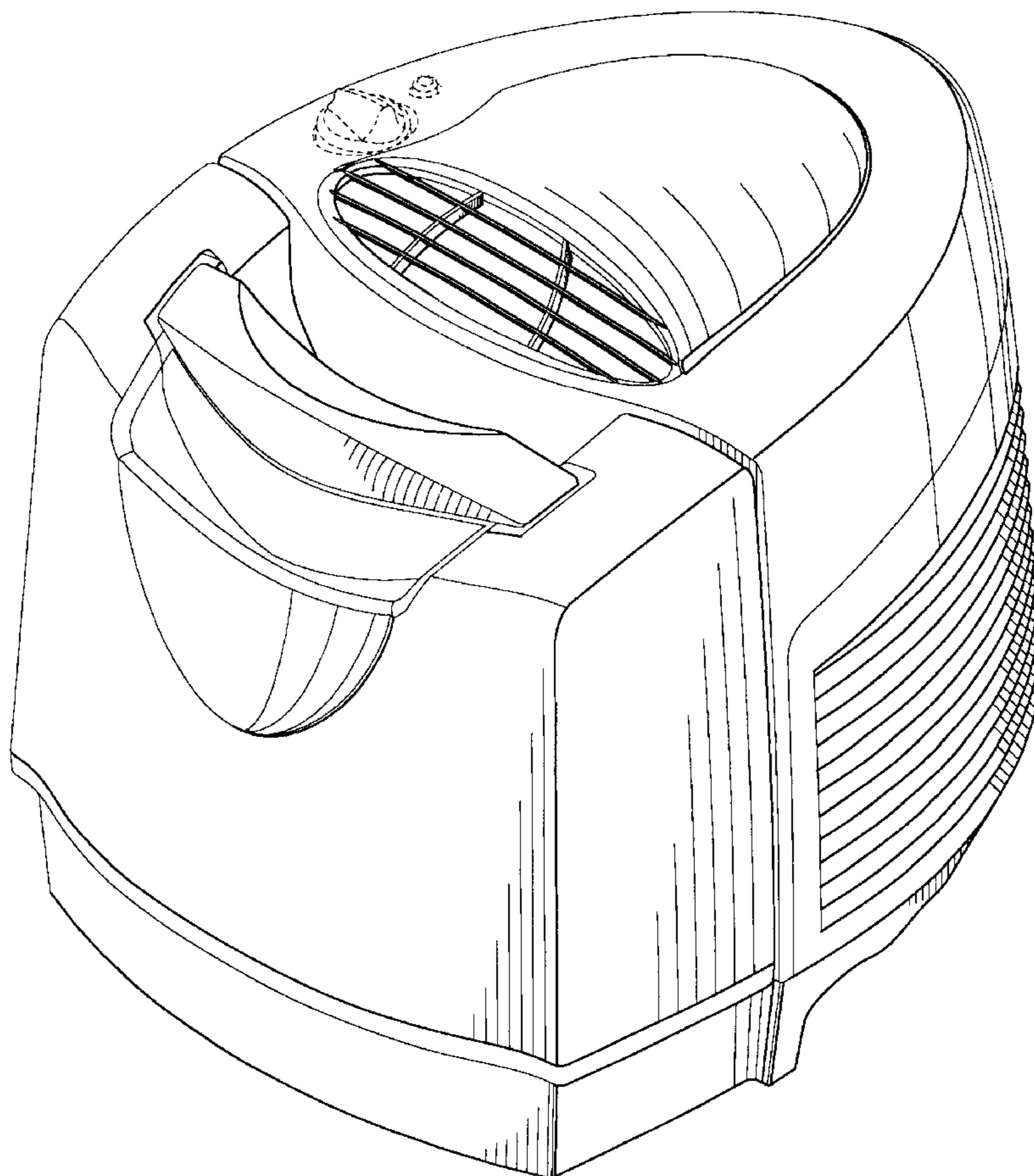

Fig. 1

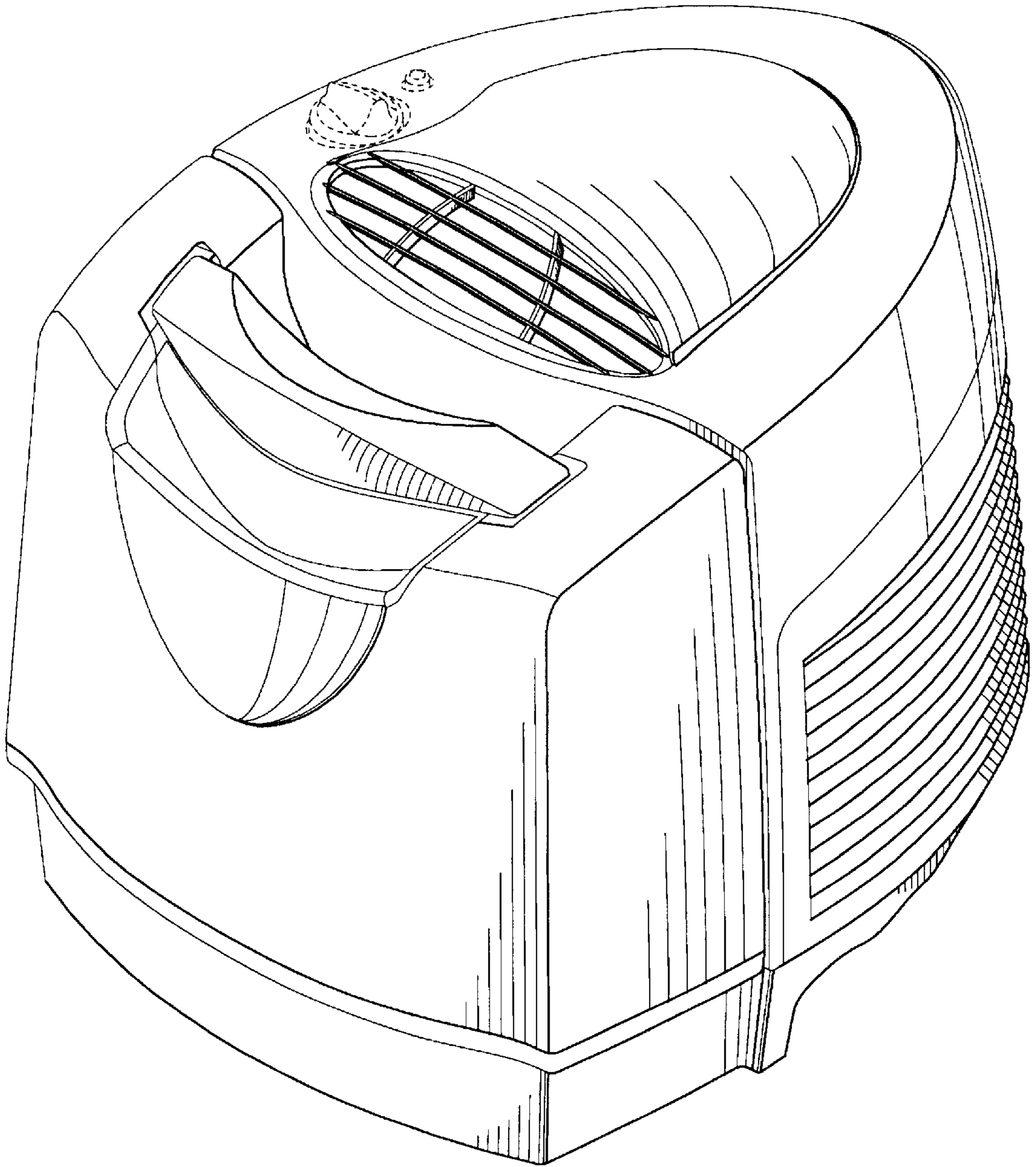

Fig. 2

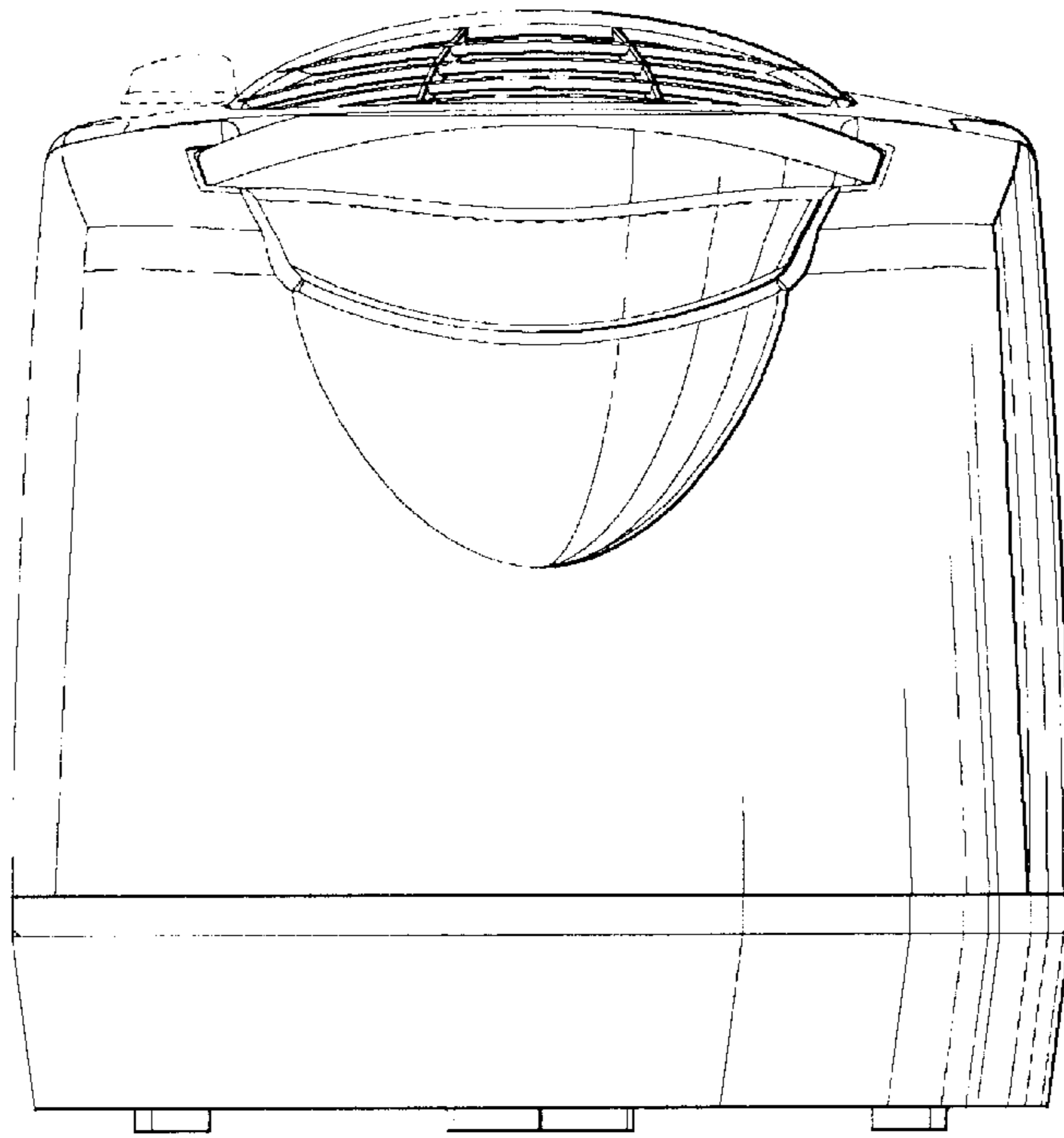

Fig. 3

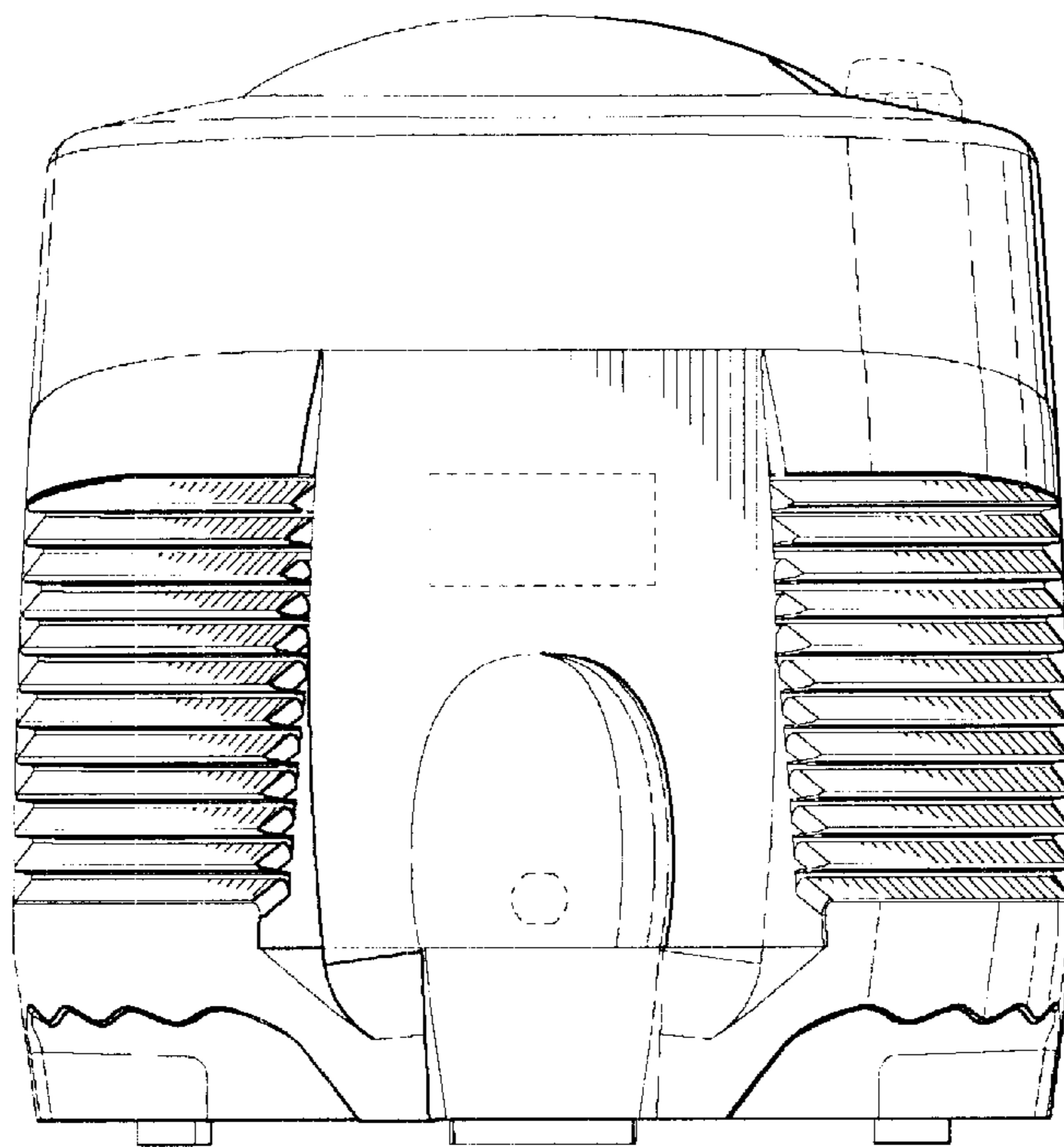

Fig. 4

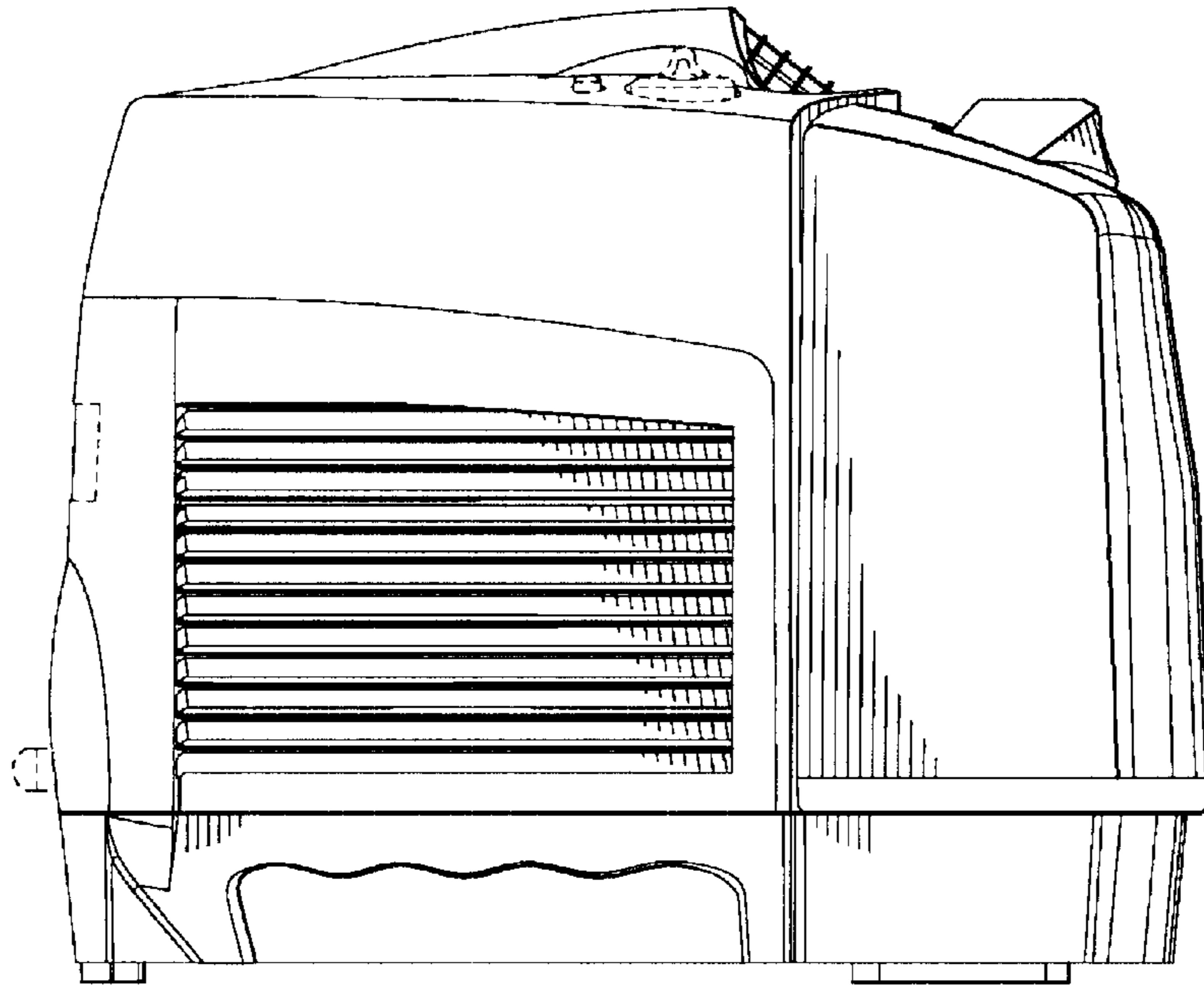

Fig. 5

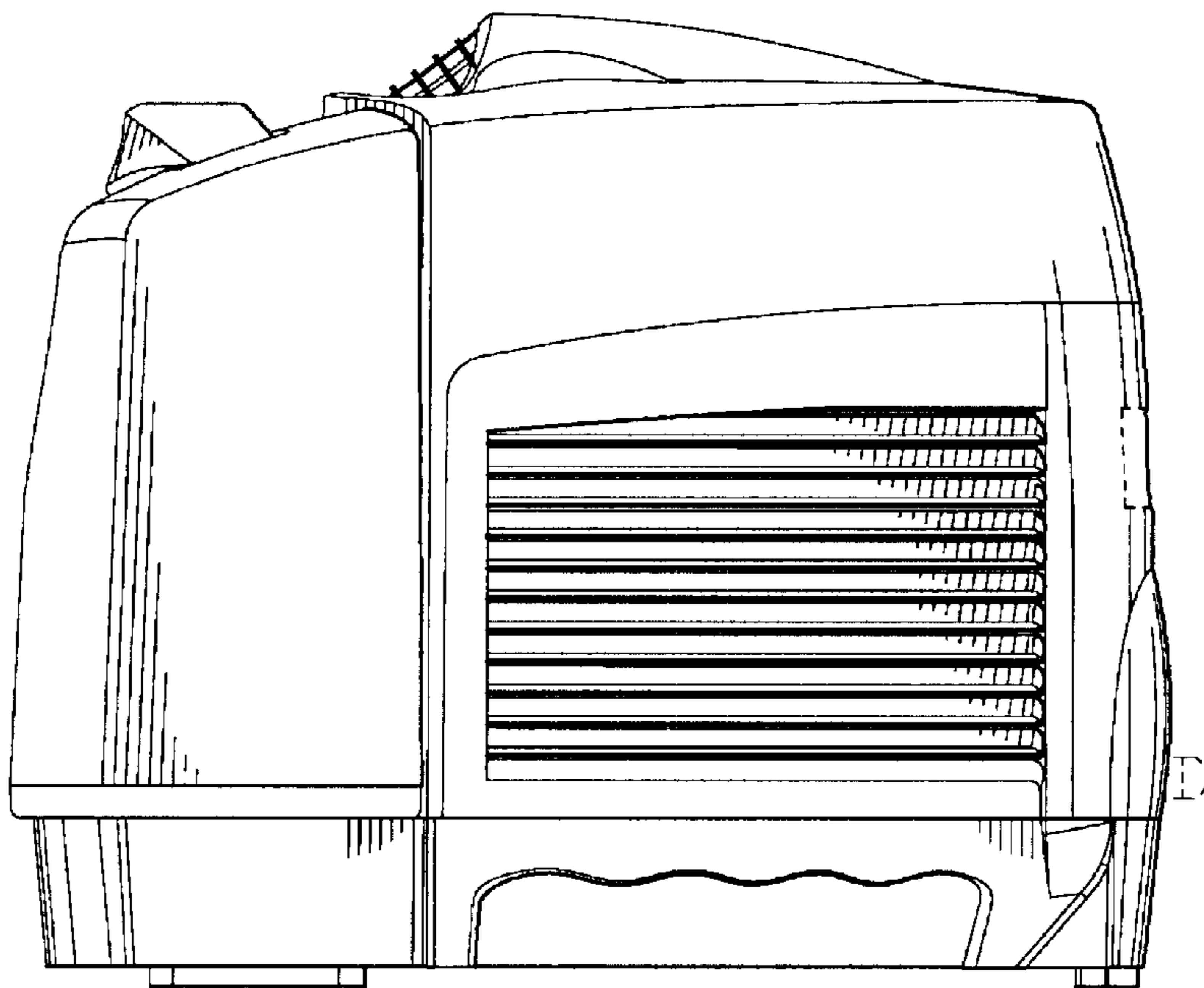

Fig. 6

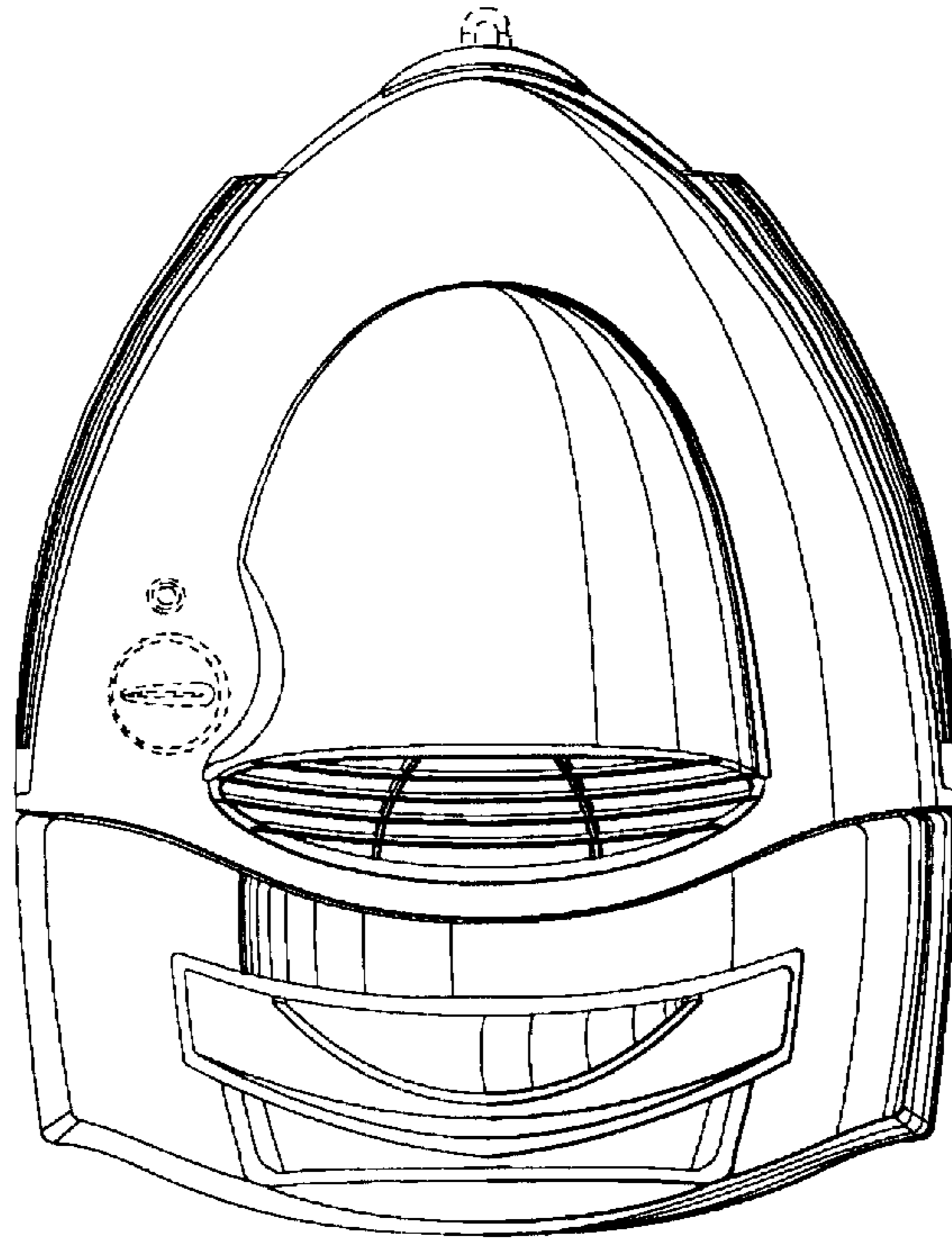

Fig. 7

