



US00D459343S

(12) **United States Design Patent**  
**Tischer**

(10) **Patent No.:** **US D459,343 S**

(45) **Date of Patent:** **\*\* Jun. 25, 2002**

(54) **MULTI-PURPOSE ANTENNA ACCESSORY FOR PROTECTION OF A PORTABLE WIRELESS COMMUNICATION DEVICE**

(75) Inventor: **Steven Neil Tischer, Atlanta, GA (US)**

(73) Assignee: **BellSouth Intellectual Property Corporation, Wilmington, DE (US)**

(\*\*) Term: **14 Years**

(21) Appl. No.: **29/146,721**

(22) Filed: **Aug. 15, 2001**

(51) **LOC (7) Cl.** ..... **14-03**

(52) **U.S. Cl.** ..... **D14/230**

(58) **Field of Search** ..... D14/230-238, D14/341-347, 432, 440, 441; D18/1, 2, 6, 7; 178/18.03, 18.08; 235/145 A, 145 R; 365/156, 168, 169; 341/22, 23; 364/708.1; 349/12; 361/680-686

(56) **References Cited**

**U.S. PATENT DOCUMENTS**

- D355,165 S \* 2/1995 Sakaguchi et al. .... D14/235
- D432,099 S \* 10/2000 Loh et al. .... D14/235
- D488,763 \* 10/2001 Ikenaga ..... D14/235

**OTHER PUBLICATIONS**

Copy of Technical Specifications Sheet of Research In Motion (RIM) Wireless Handheld devices—downloaded from Internet on Jun. 12, 2001.

\* cited by examiner

*Primary Examiner*—Louis S. Zarfes  
*Assistant Examiner*—Gregory Andoll  
(74) *Attorney, Agent, or Firm*—Kirkpatrick & Lockhart LLP

(57) **CLAIM**

The ornamental design for the multi-purpose antenna accessory for protection of a portable wireless communication device, as shown and described.

**DESCRIPTION**

FIG. 1 is a perspective view of one embodiment of the multipurpose antenna accessory for protection of a portable wireless communication device of the present invention in a first position;

FIG. 2 is a top view of the multipurpose antenna accessory for protection of a portable wireless communication device of FIG. 1;

FIG. 3 is a bottom view of the multipurpose antenna accessory for protection of a portable wireless communication device of FIGS. 1 and 2;

FIG. 4 is a front view of the multipurpose antenna accessory for protection of a portable wireless communication device of FIGS. 1-3;

FIG. 5 is a rear view of the multipurpose antenna accessory for protection of a portable wireless communication device of FIGS. 1-4;

FIG. 6 is a right side view of the multipurpose antenna accessory for protection of a portable wireless communication device of FIGS. 1-5;

FIG. 7 is a left side view of the multipurpose antenna accessory for protection of a portable wireless communication device of FIGS. 1-6;

FIG. 8 is a perspective view of the embodiment of the multipurpose antenna accessory for protection of a portable wireless communication device of FIGS. 1-7 in a second position;

FIG. 9 is a top view of the multipurpose antenna accessory for protection of a portable wireless communication device of FIG. 8;

FIG. 10 is a bottom view of the multipurpose antenna accessory for protection of a portable wireless communication device of FIGS. 8 and 9;

FIG. 11 is a front view of the multipurpose antenna accessory for protection of a portable wireless communication device of FIGS. 8-10;

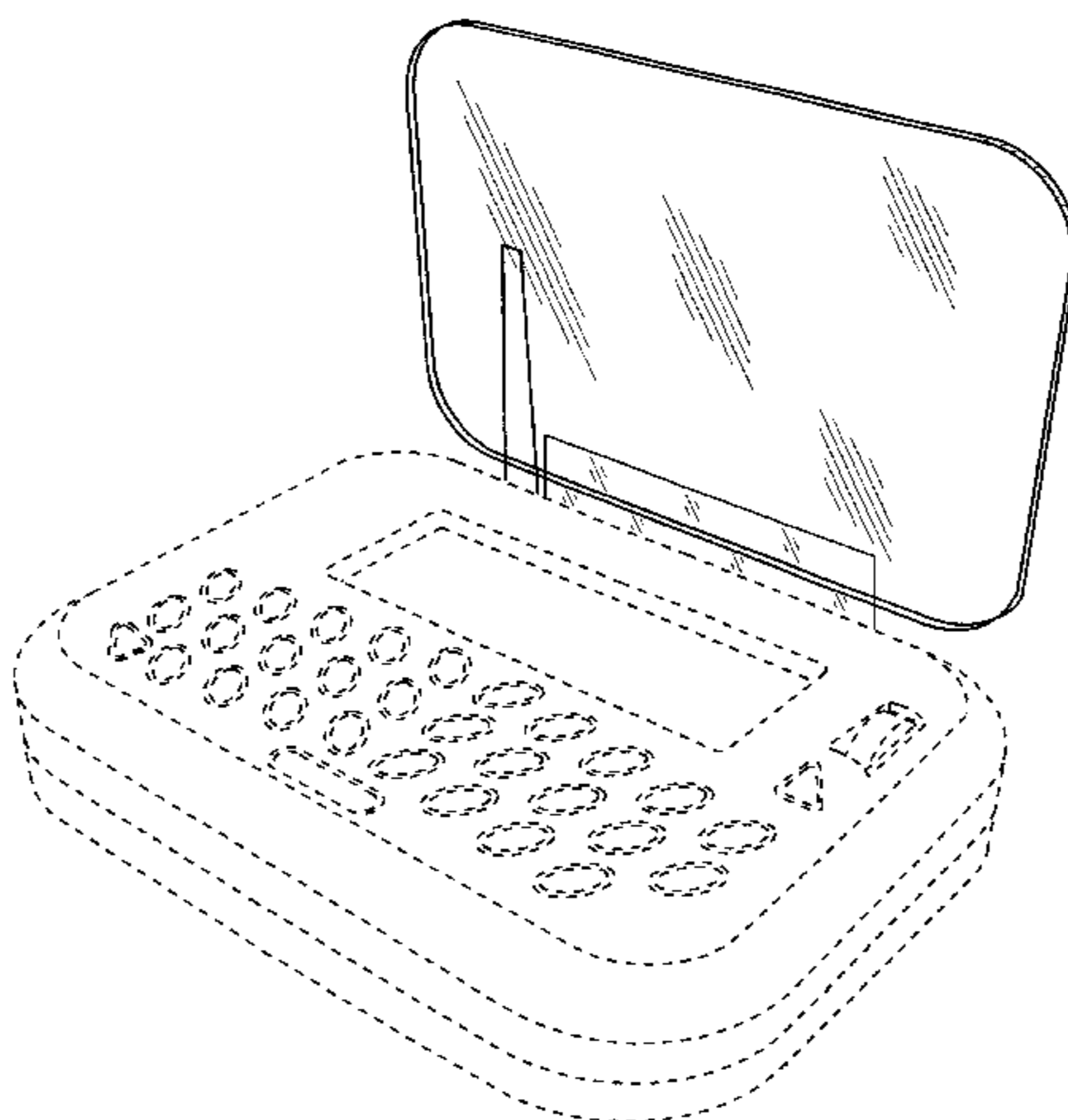


FIG. 12 is a rear view of the multipurpose antenna accessory for protection of a portable wireless communication device of FIGS. 8-11;

FIG. 13 is a right side view of the multipurpose antenna accessory for protection of a portable wireless communication device of FIGS. 8-12;

FIG. 14 is a left side view of the multipurpose antenna accessory for protection of a portable wireless communication device of FIGS. 8-13;

FIG. 15 is a perspective view of another embodiment of the multipurpose antenna accessory for protection of a portable wireless communication device of the present invention;

FIG. 16 is a top view of the multipurpose antenna accessory for protection of a portable wireless communication device of FIG. 15;

FIG. 17 is a bottom view of the multipurpose antenna accessory for protection of a portable wireless communication device of FIGS. 15 and 16;

FIG. 18 is a front view of the multipurpose antenna accessory for protection of a portable wireless communication device of FIGS. 15-17;

FIG. 19 is a rear view of the multipurpose antenna accessory for protection of a portable wireless communication device of FIGS. 15-18;

FIG. 20 is a right side view of the multipurpose antenna accessory for protection of a portable wireless communication device of FIGS. 15-19;

FIG. 21 is a left side view of the multipurpose antenna accessory for protection of a portable wireless communication device of FIGS. 15-20;

FIG. 22 is a perspective view of another embodiment of the multipurpose antenna accessory for protection of a portable wireless communication device of the present invention;

FIG. 23 is a top view of the multipurpose antenna accessory for protection of a portable wireless communication device of FIG. 22;

FIG. 24 is a bottom view of the multipurpose antenna accessory for protection of a portable wireless communication device of FIGS. 22 and 23;

FIG. 25 is a front view of the multipurpose antenna accessory for protection of a portable wireless communication device of FIGS. 22-24;

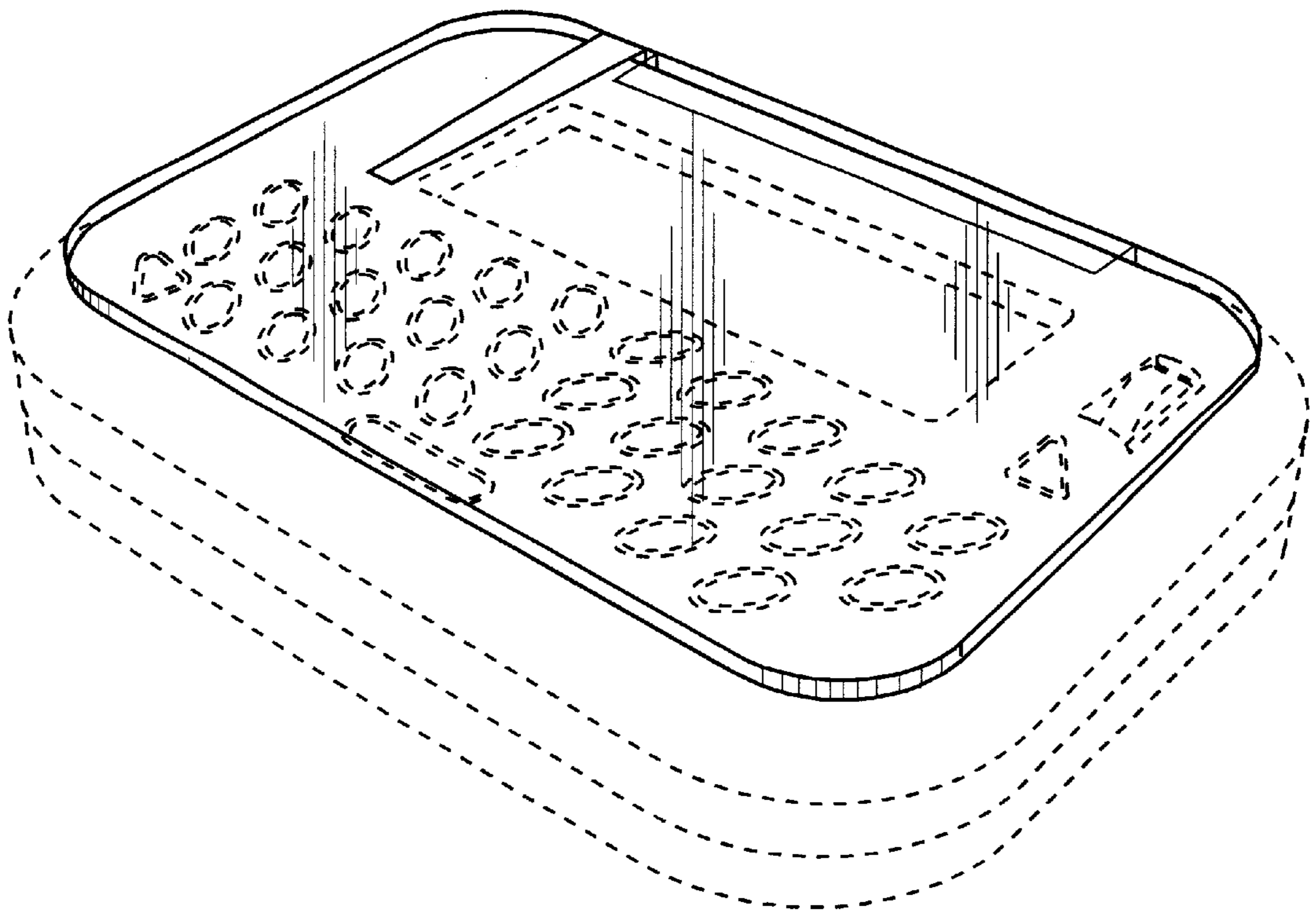
FIG. 26 is a rear view of the multipurpose antenna accessory for protection of a portable wireless communication device of FIGS. 22-25;

FIG. 27 is a right side view of the multipurpose antenna accessory for protection of a portable wireless communication device of FIGS. 22-26; and,

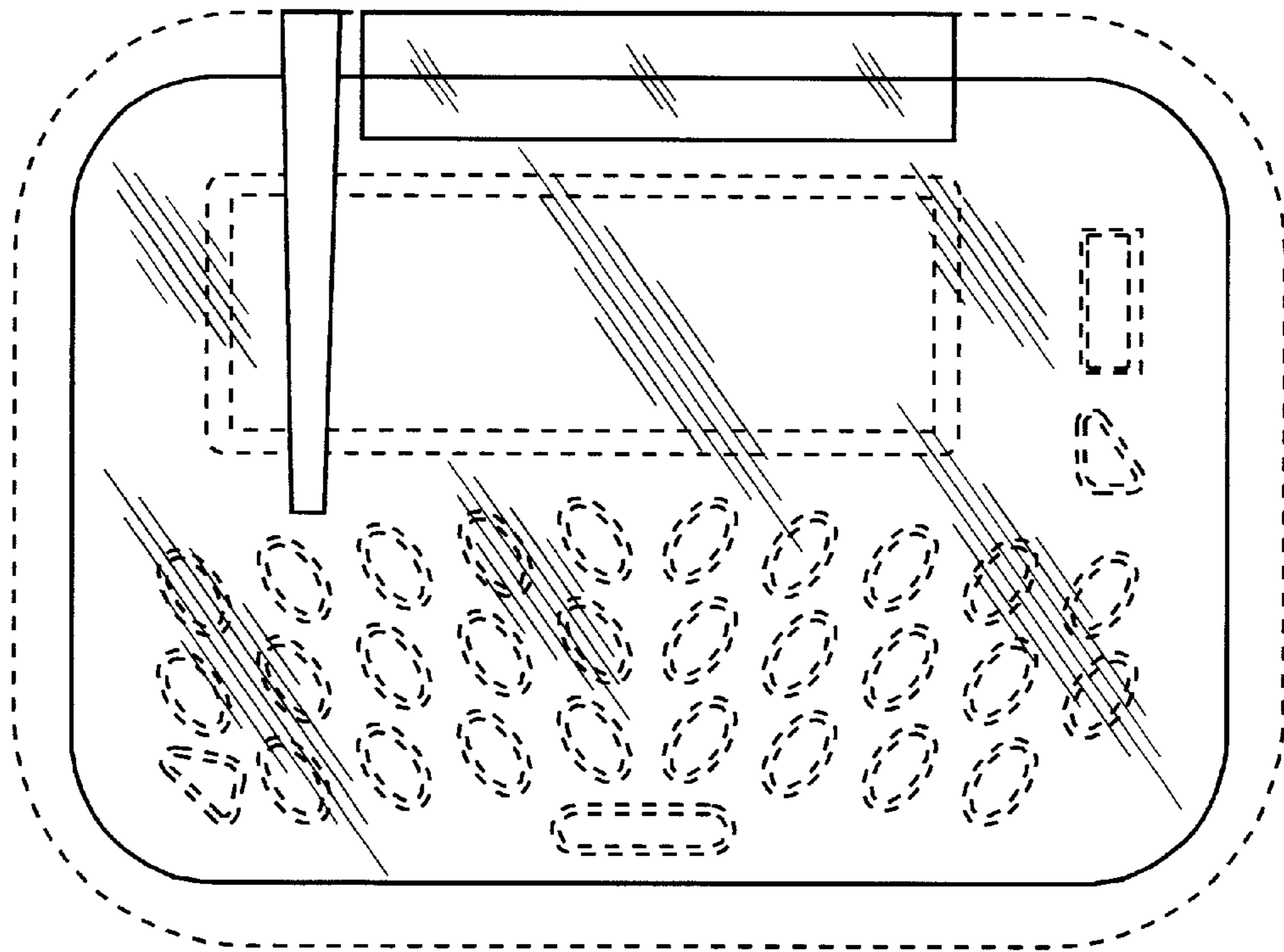
FIG. 28 is a left side view of the multipurpose antenna accessory for protection of a portable wireless communication device of FIGS. 22-27.

The broken lines in the Figures are for illustrative purposes only and form no part of the claimed design.

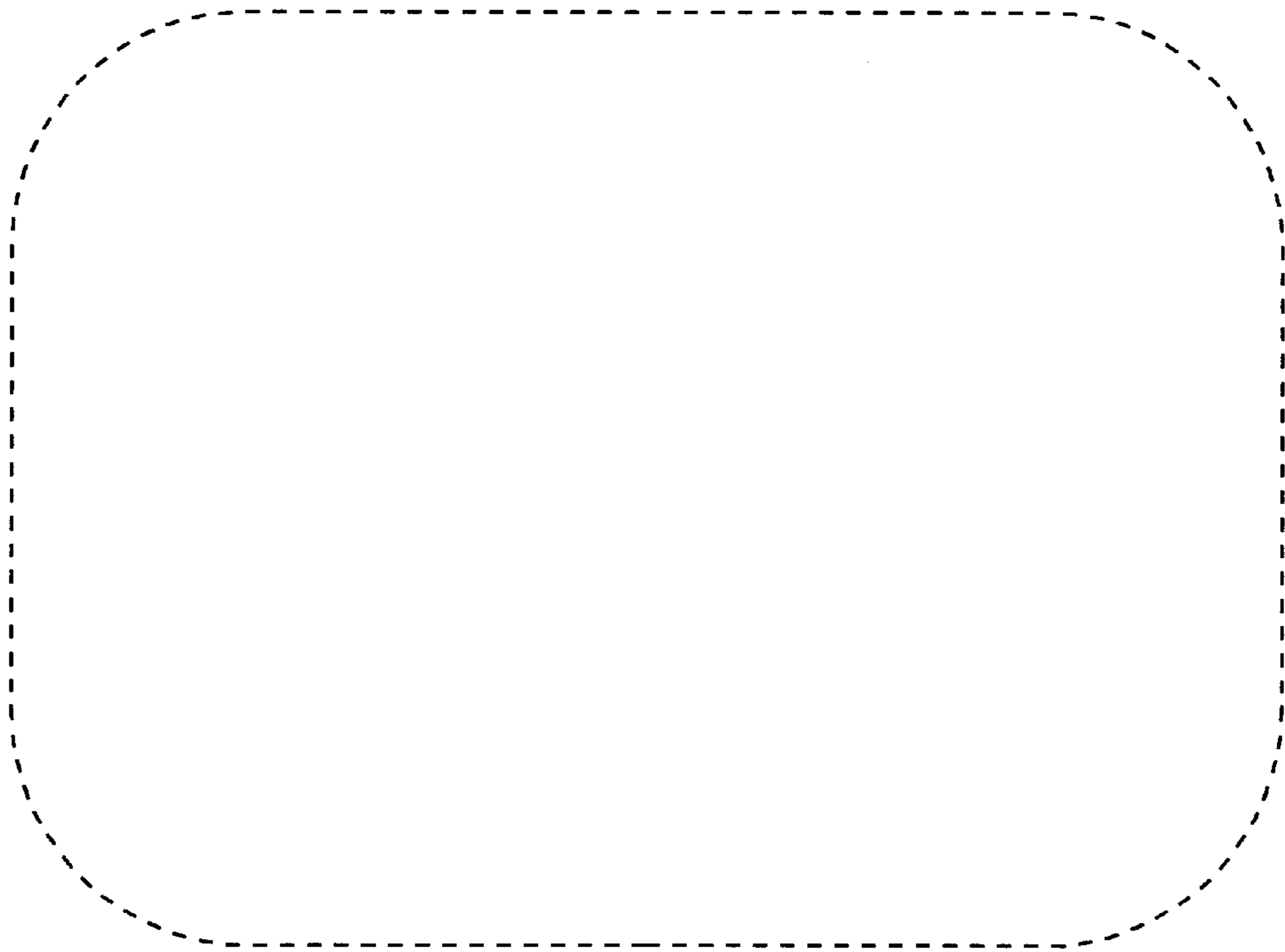
**1 Claim, 16 Drawing Sheets**



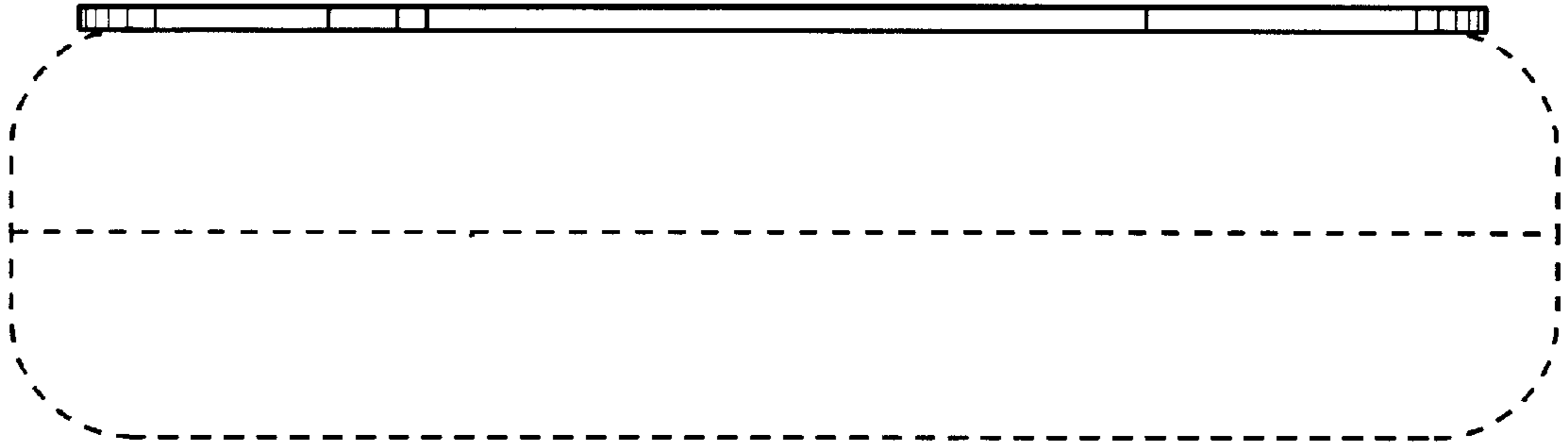
*Fig. 1*



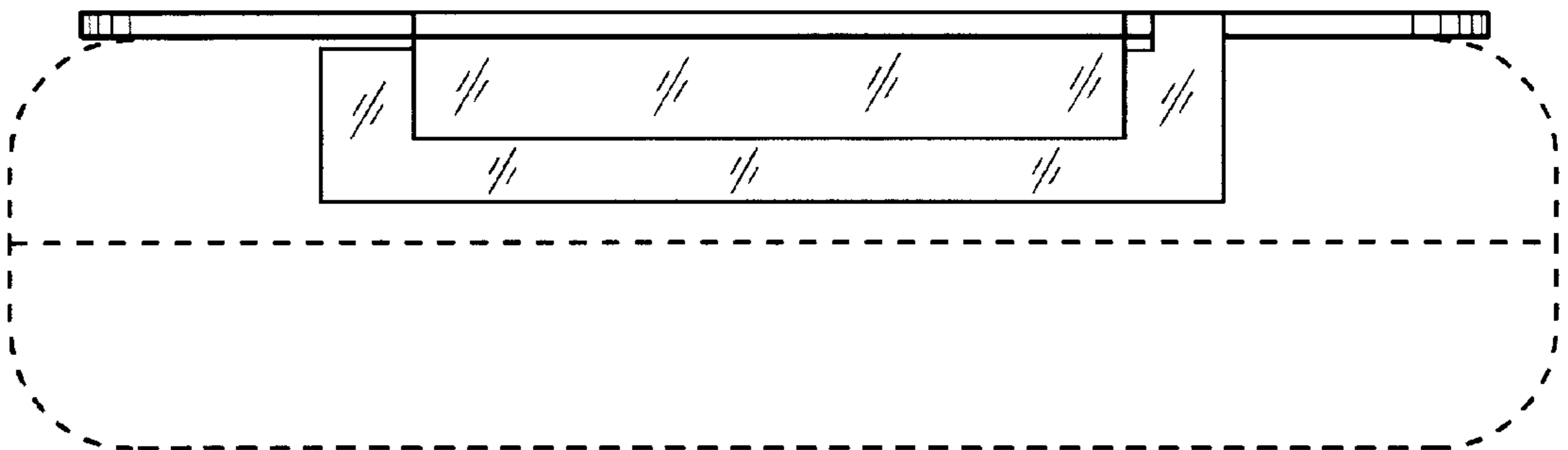
*Fig. 2*



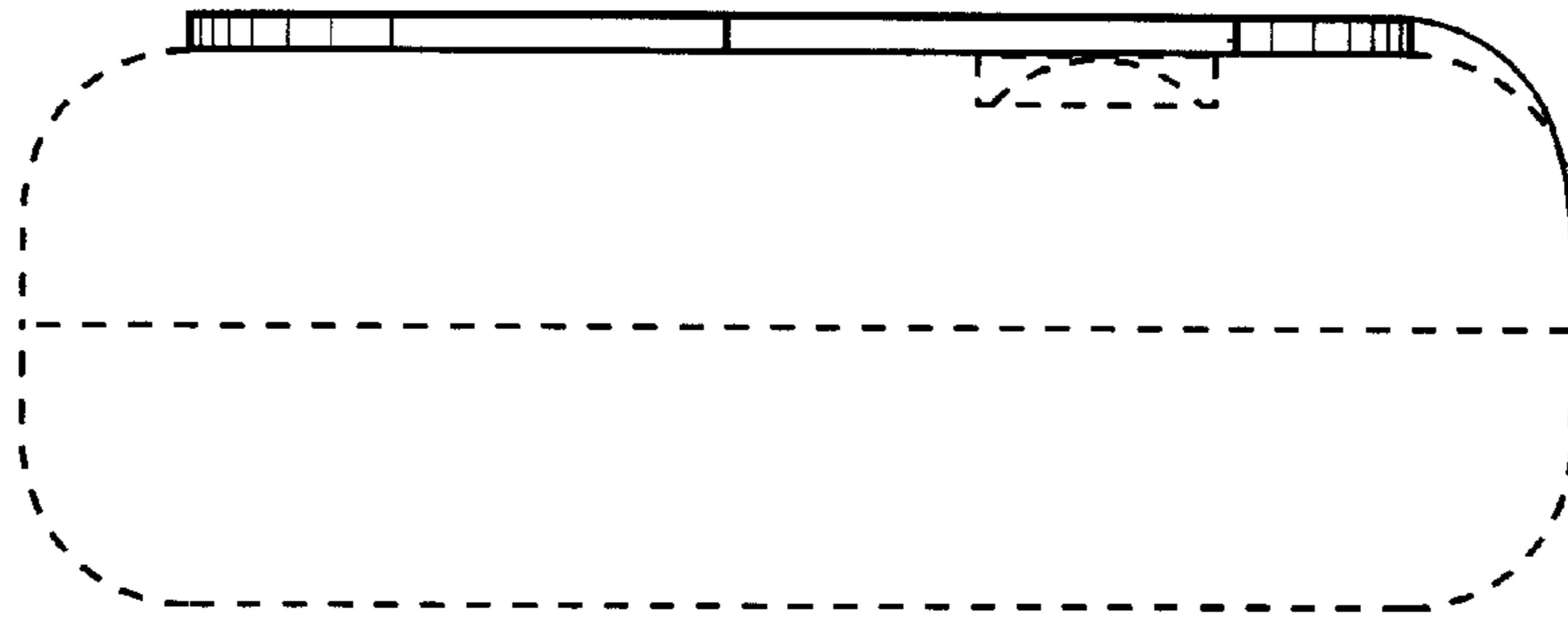
*Fig. 3*



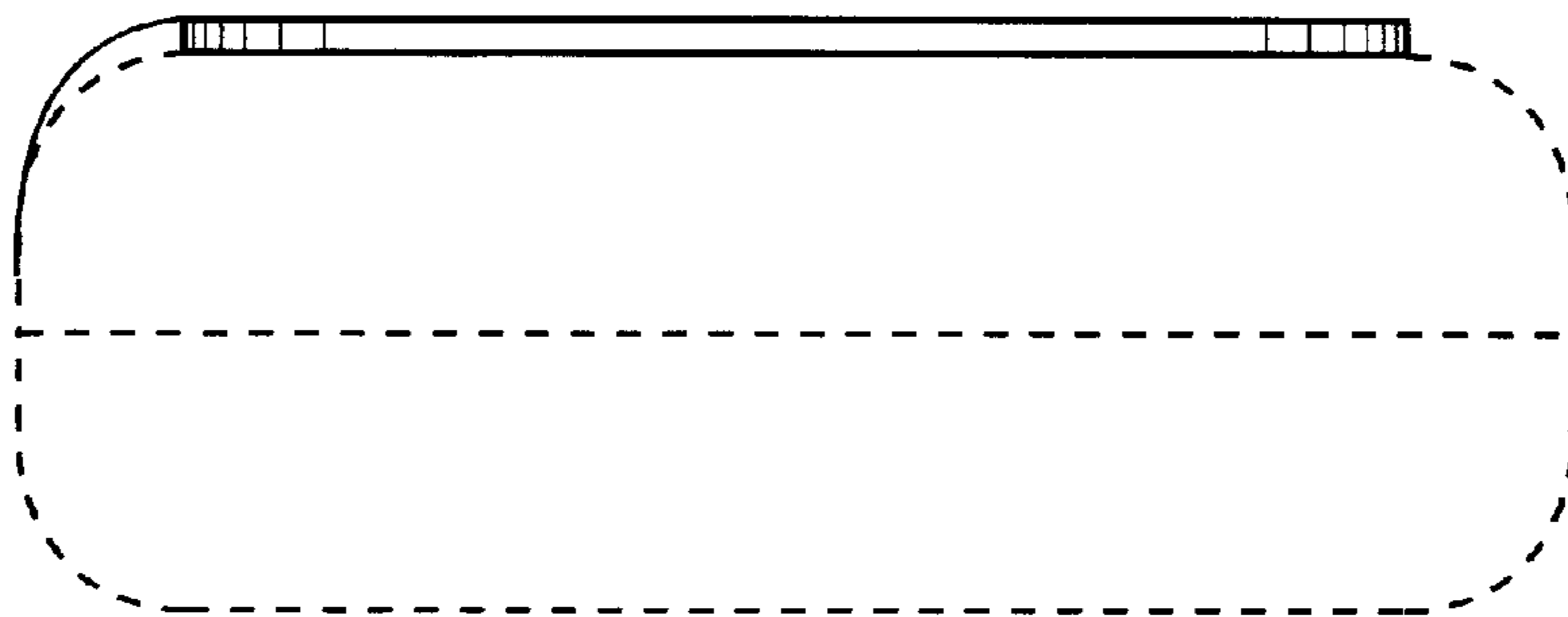
*Fig.4*



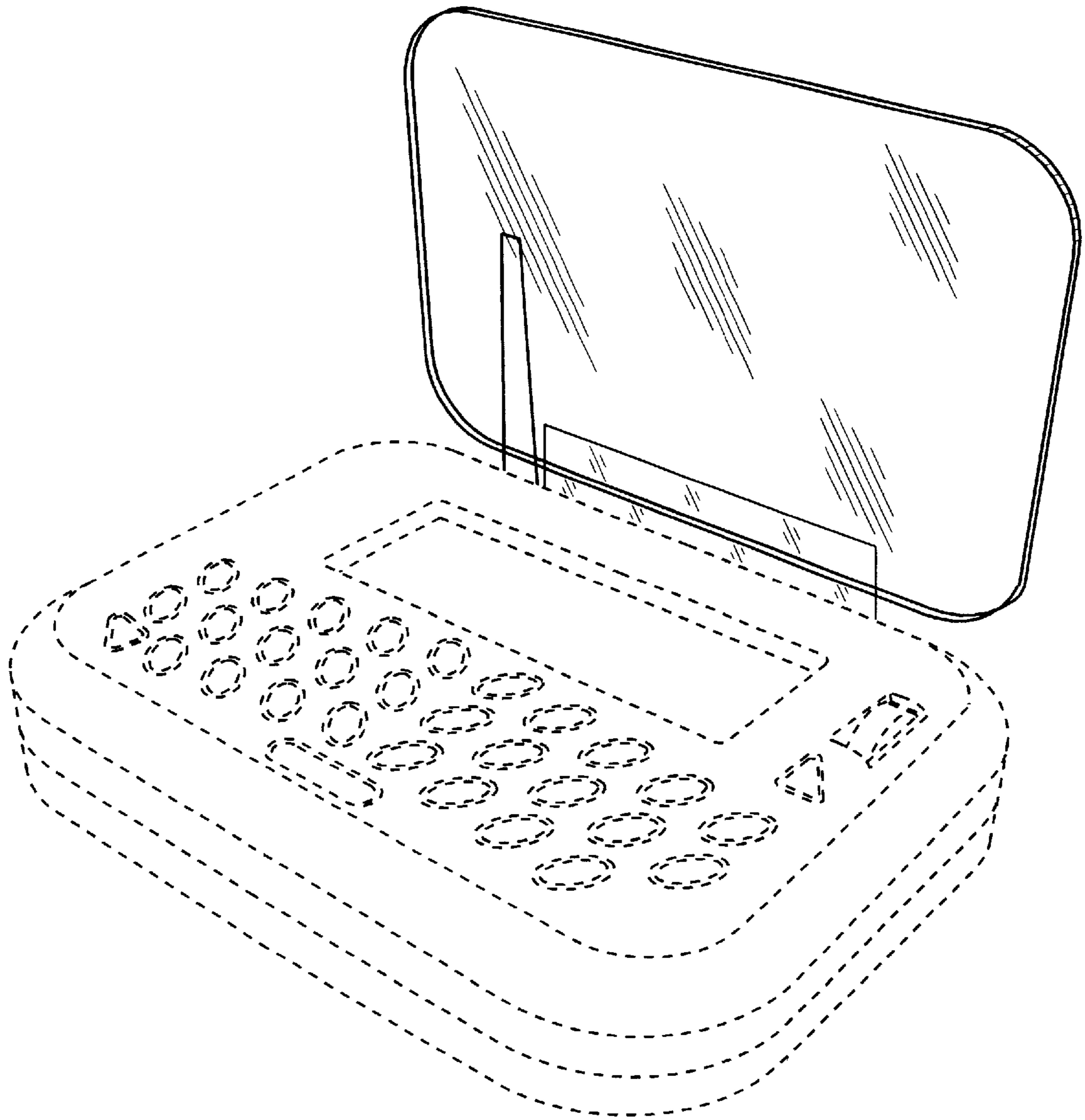
*Fig.5*



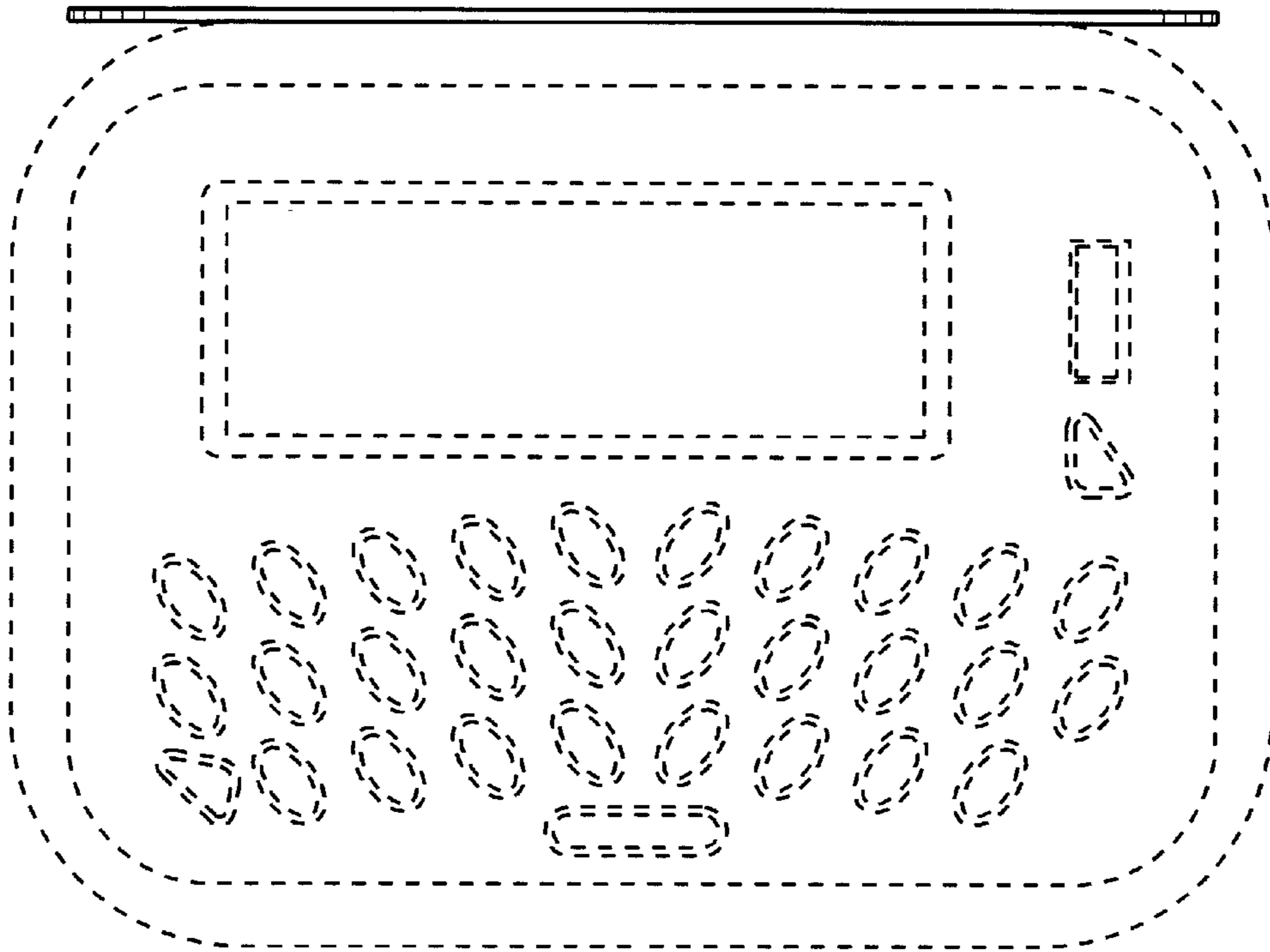
*Fig. 6*



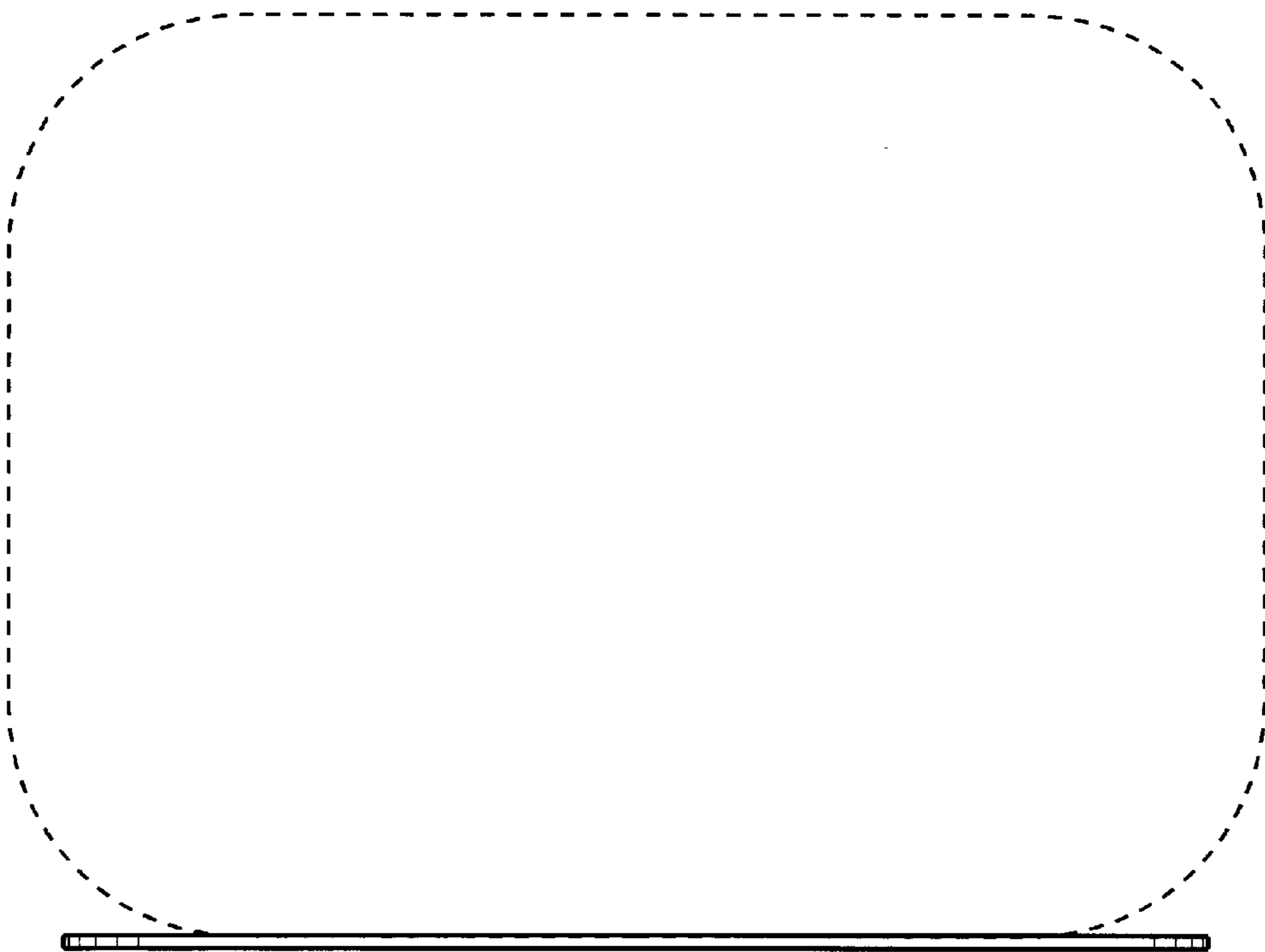
*Fig. 7*



*Fig.8*

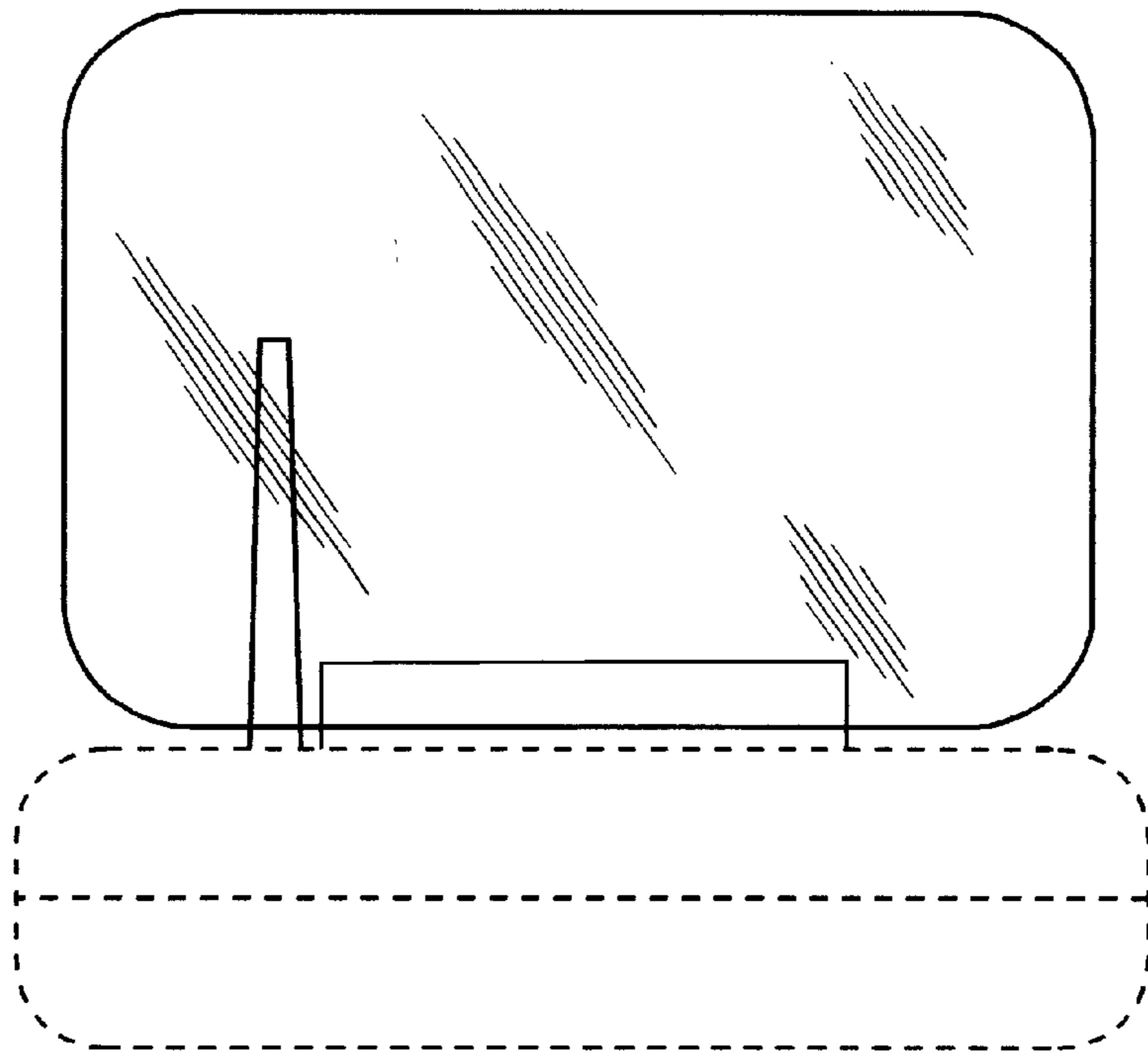


*Fig. 9*

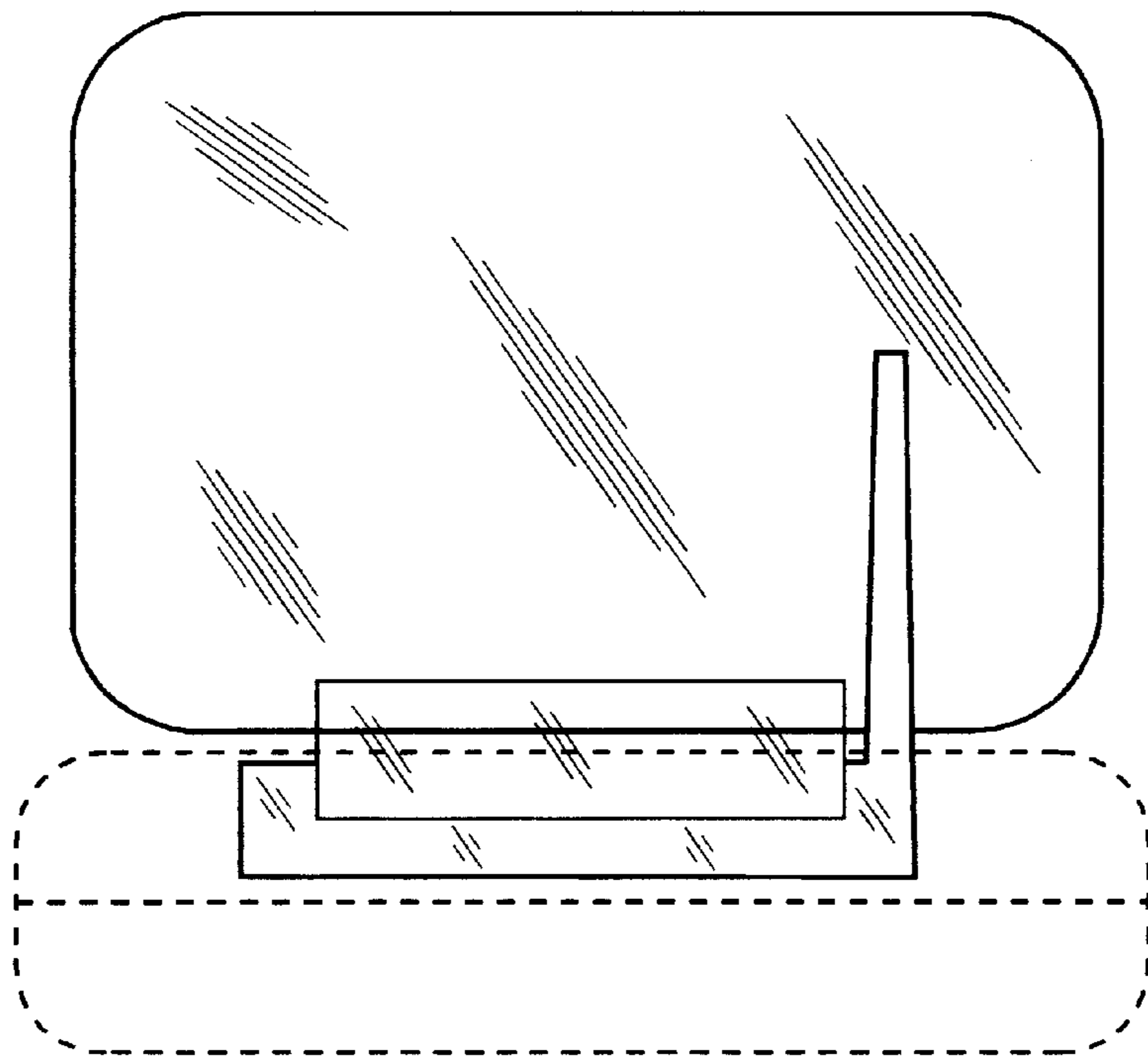


*Fig. 10*

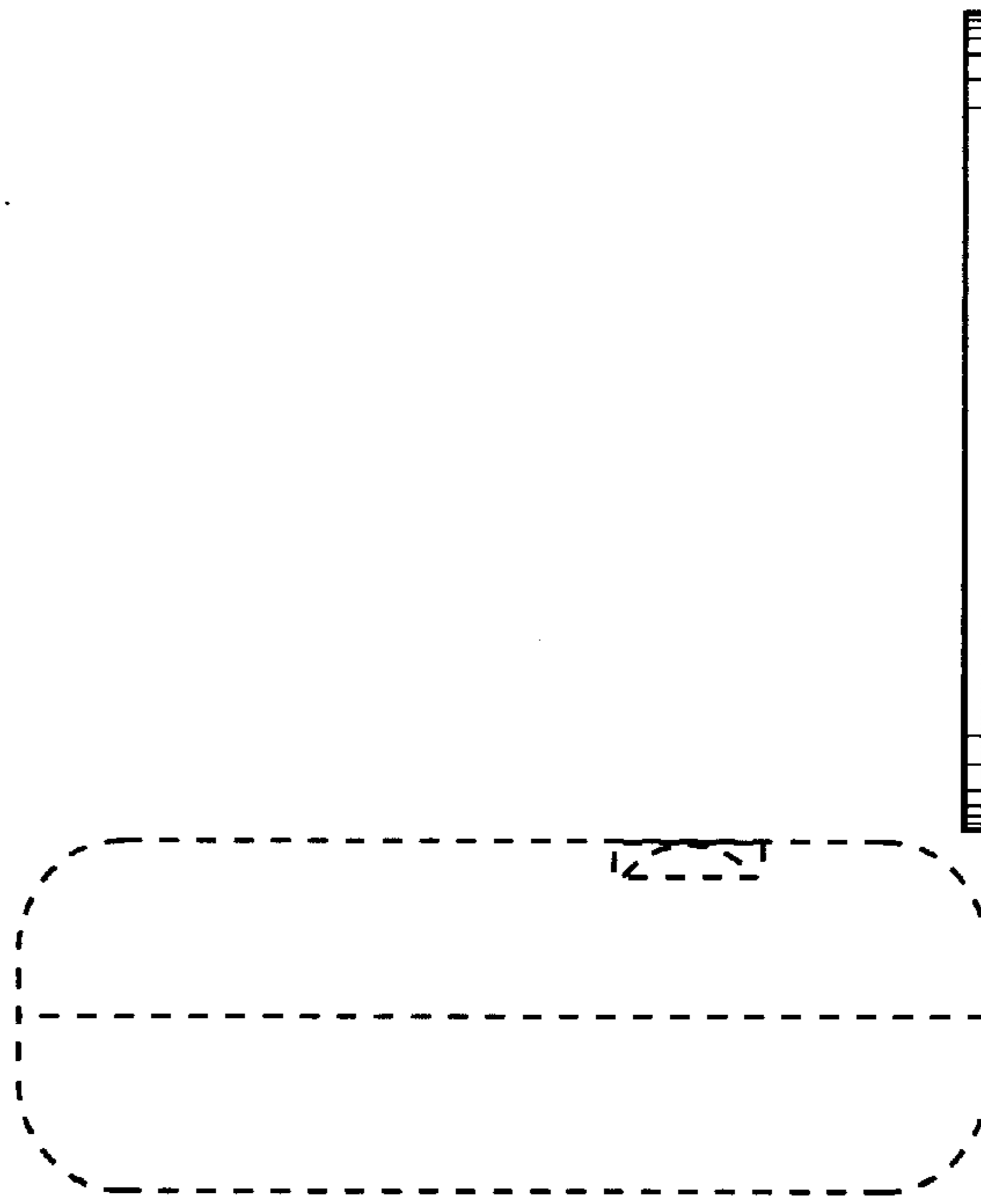




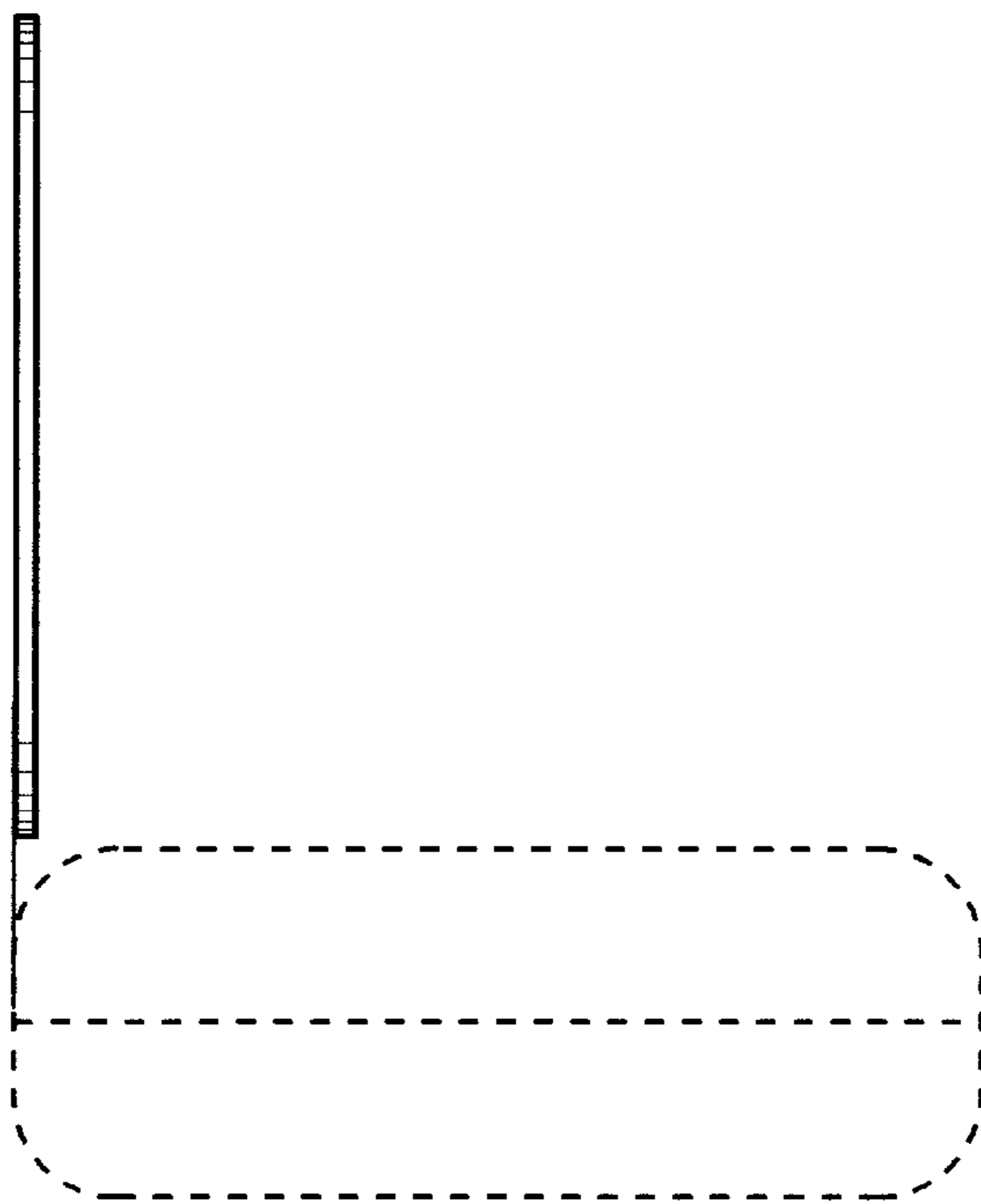
*Fig.11*



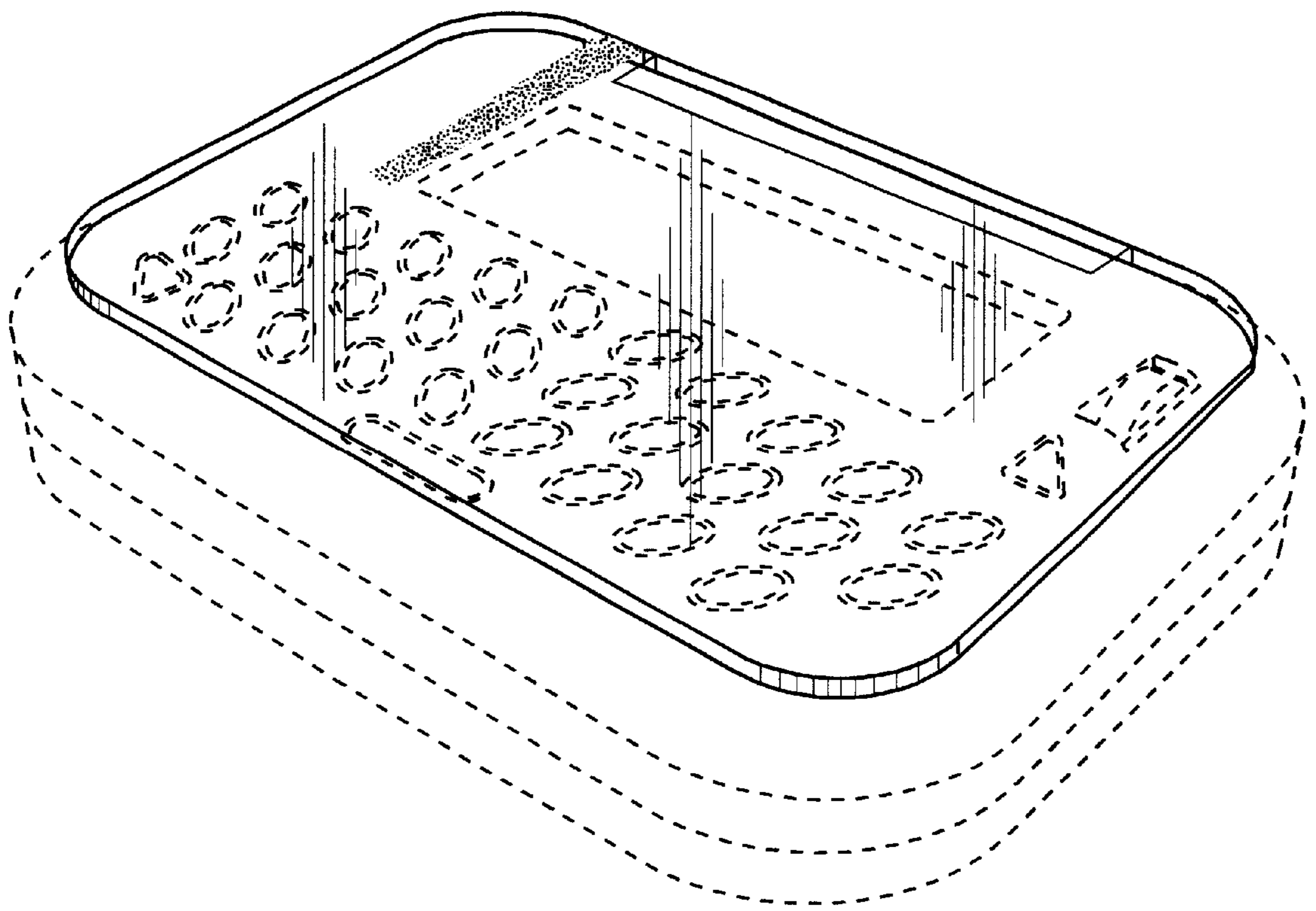
*Fig.12*



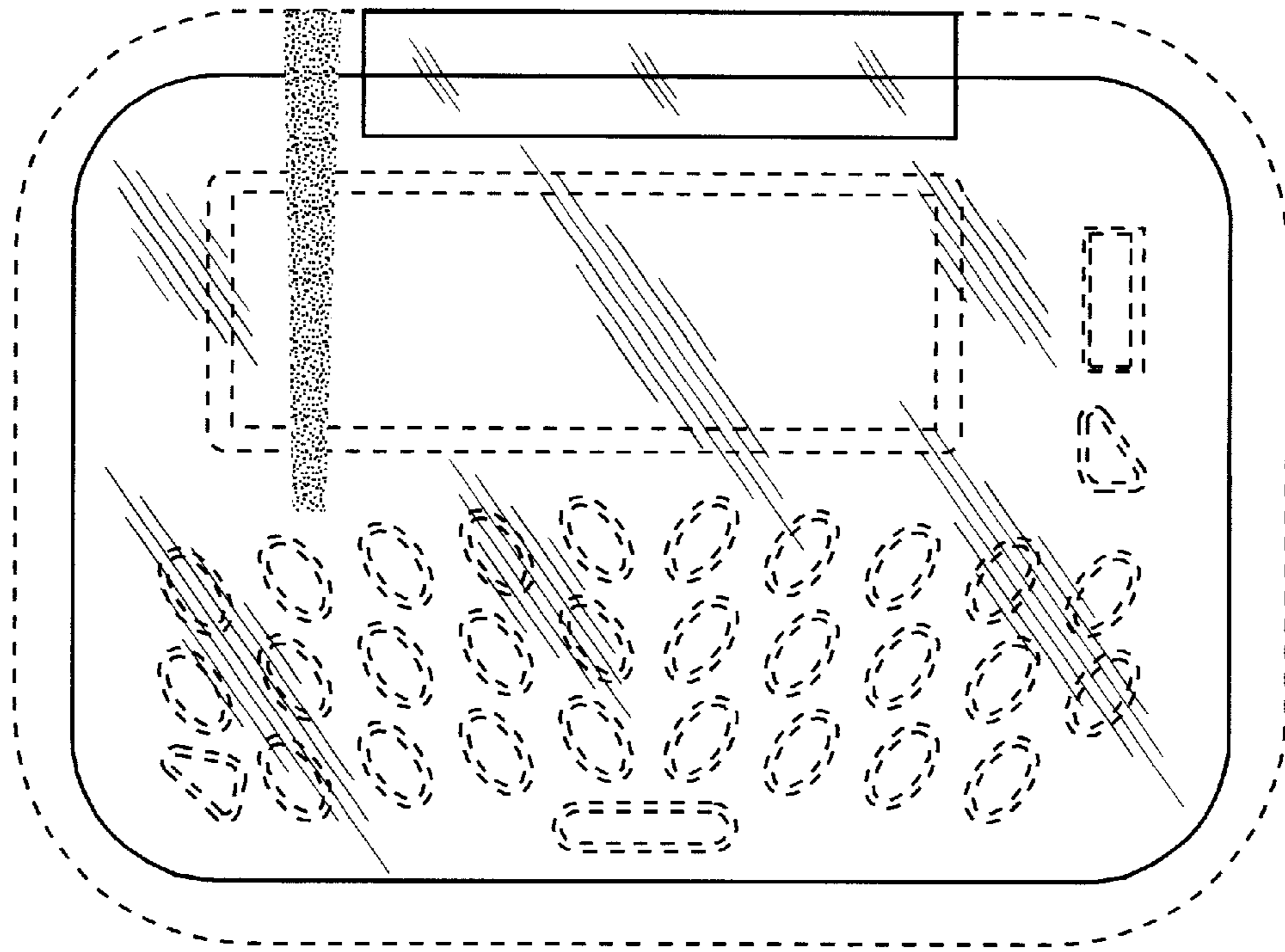
*Fig.13*



*Fig.14*



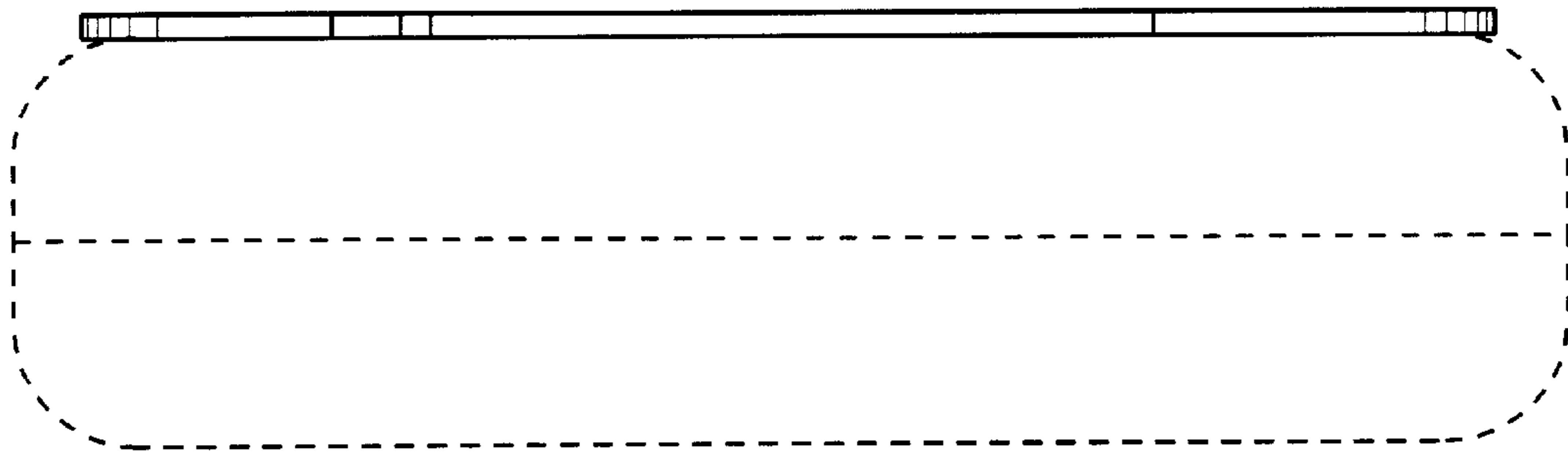
*Fig.15*



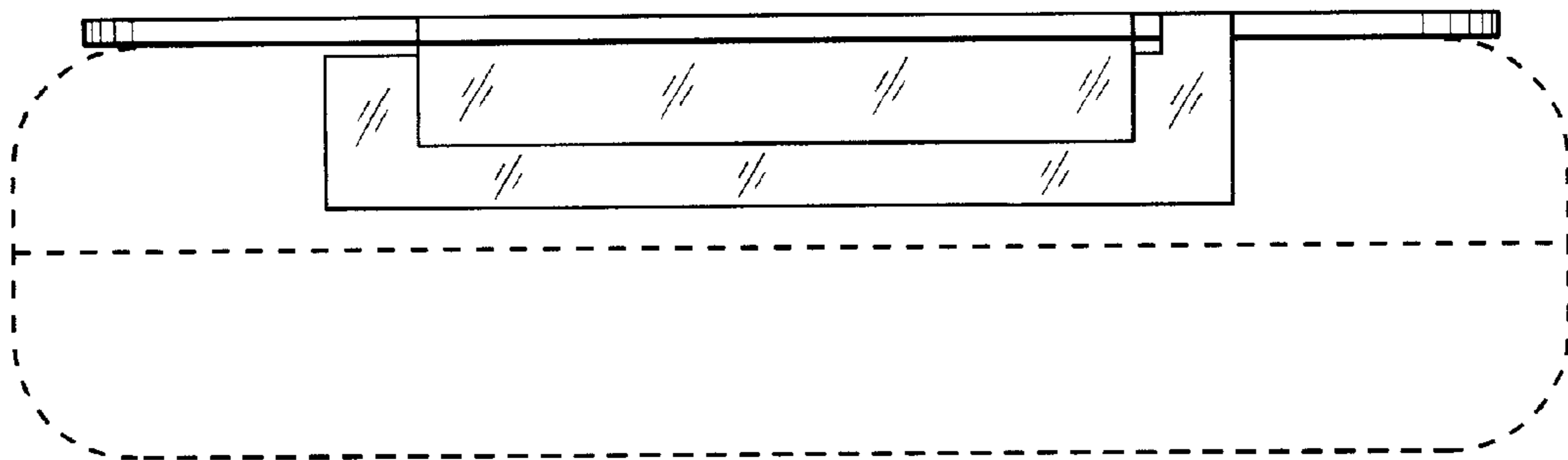
*Fig.16*



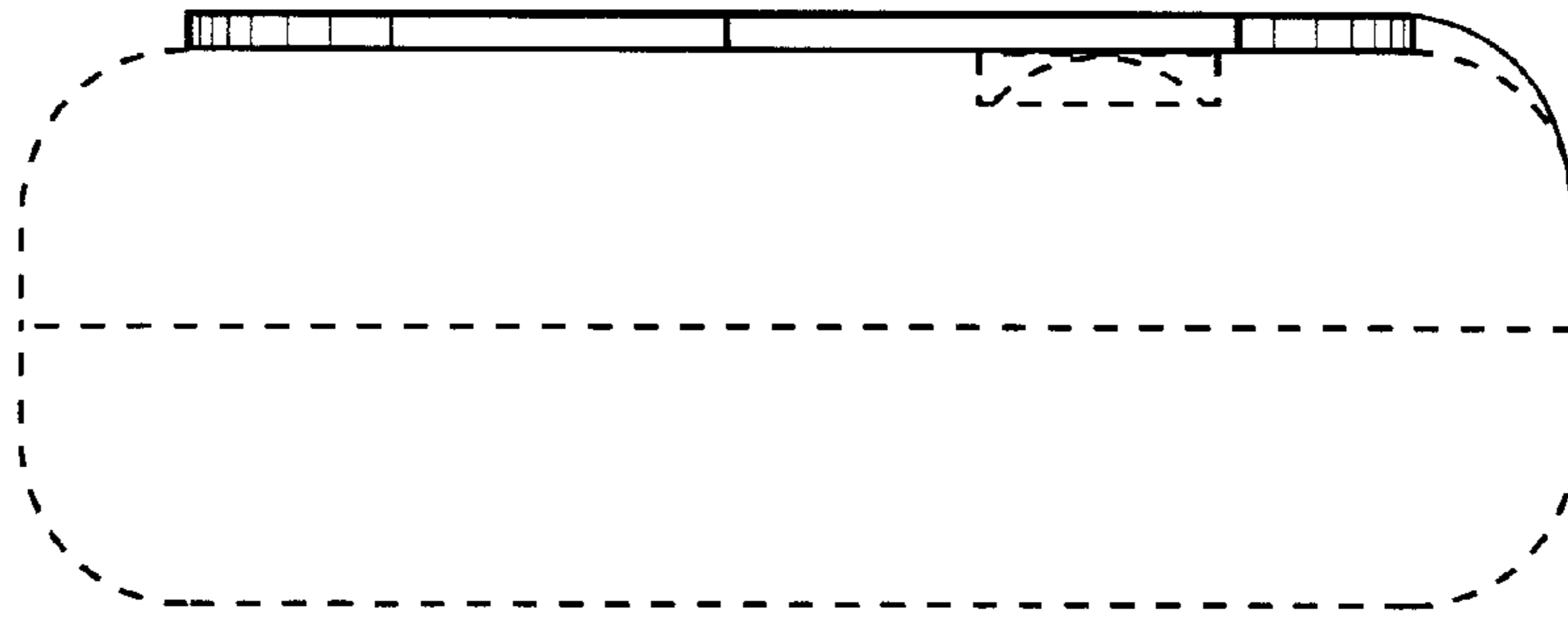
*Fig.17*



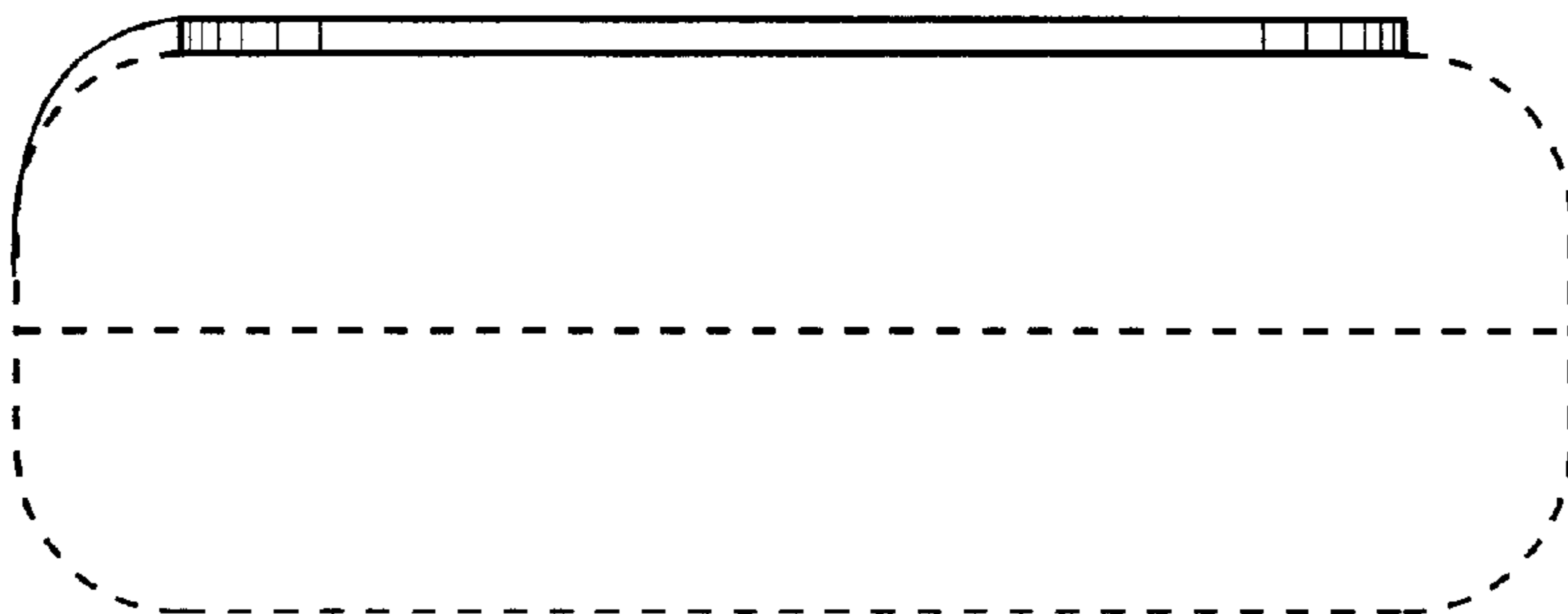
*Fig. 18*



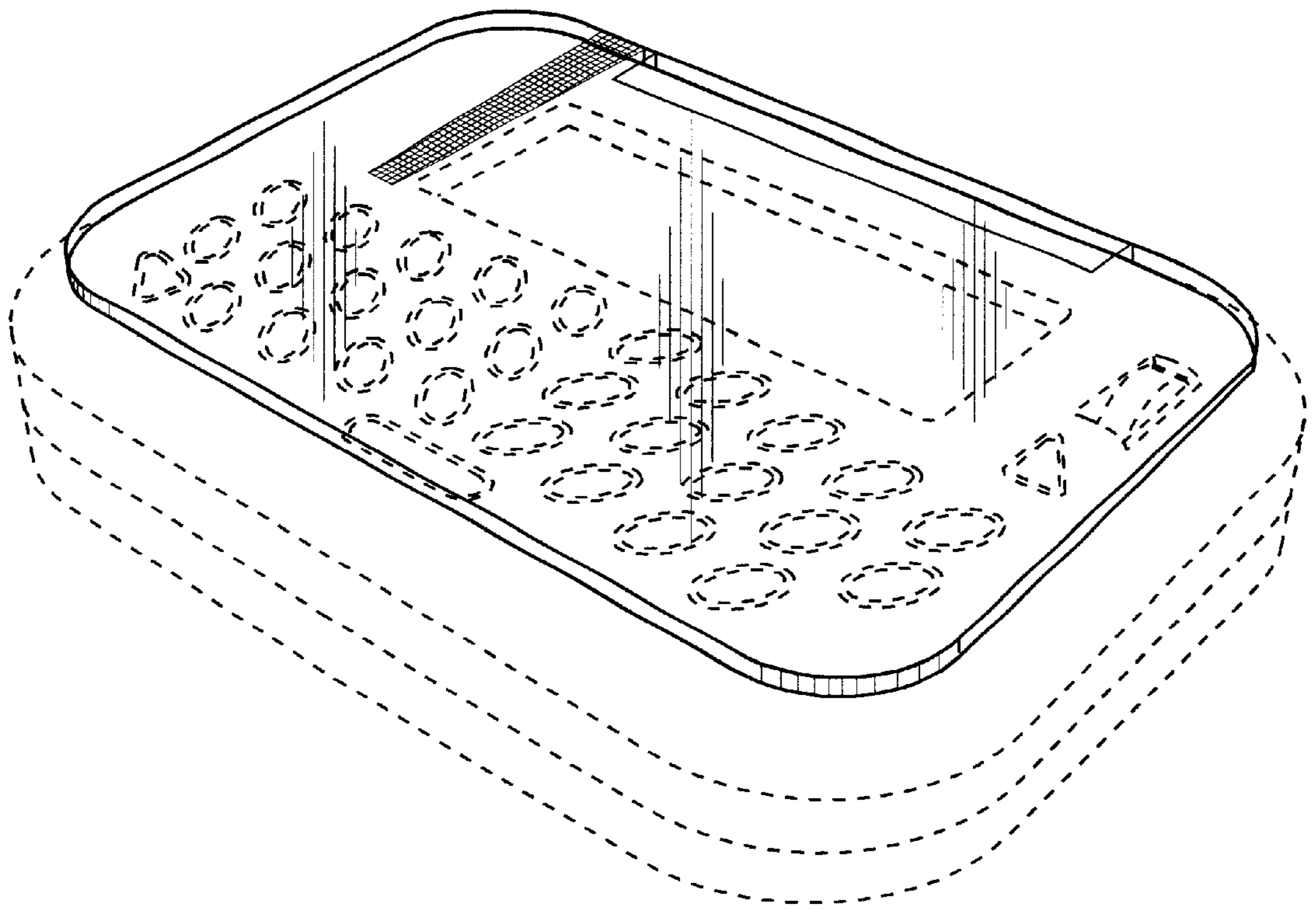
*Fig. 19*



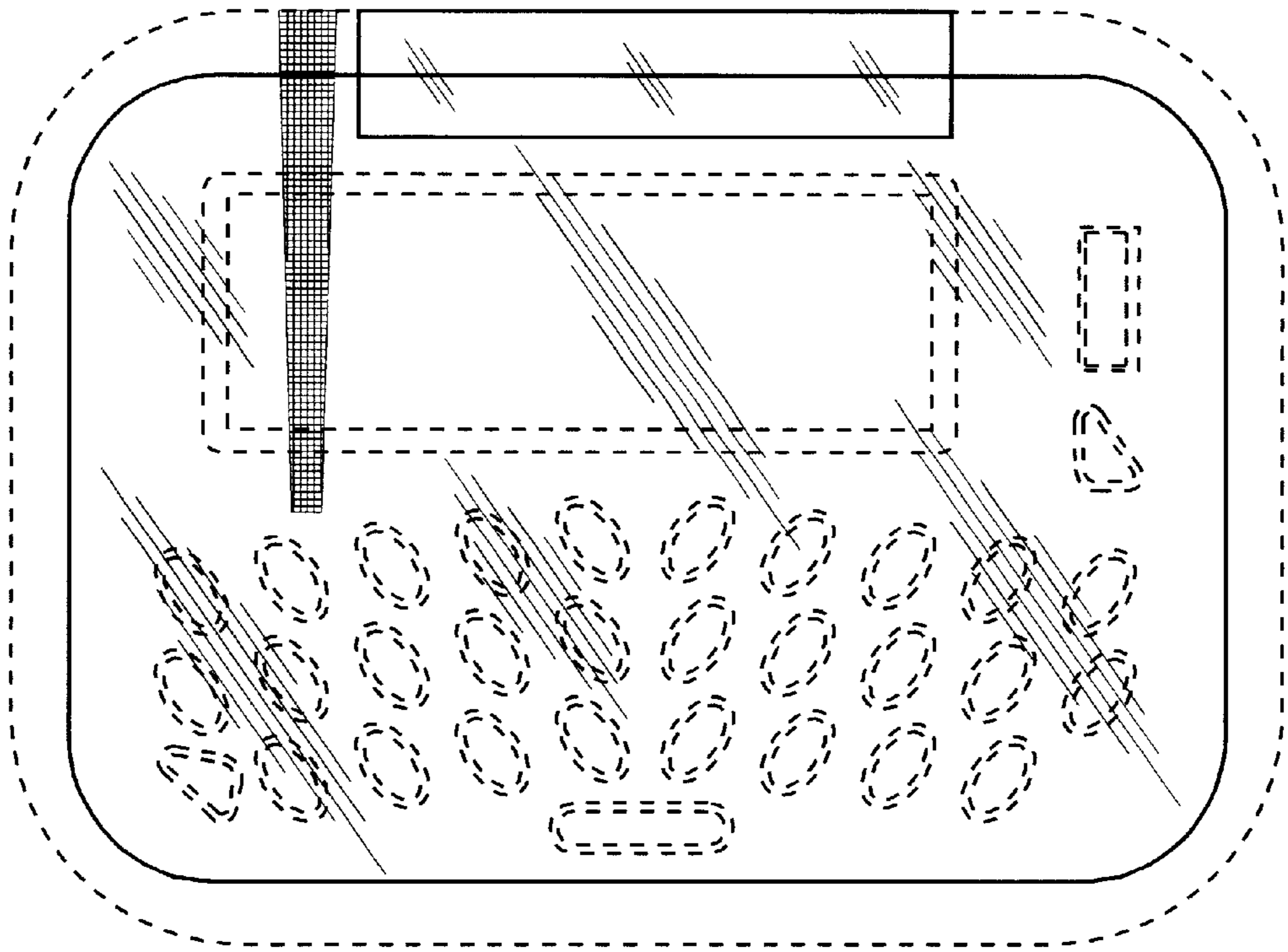
*Fig. 20*



*Fig. 21*



*Fig.22*

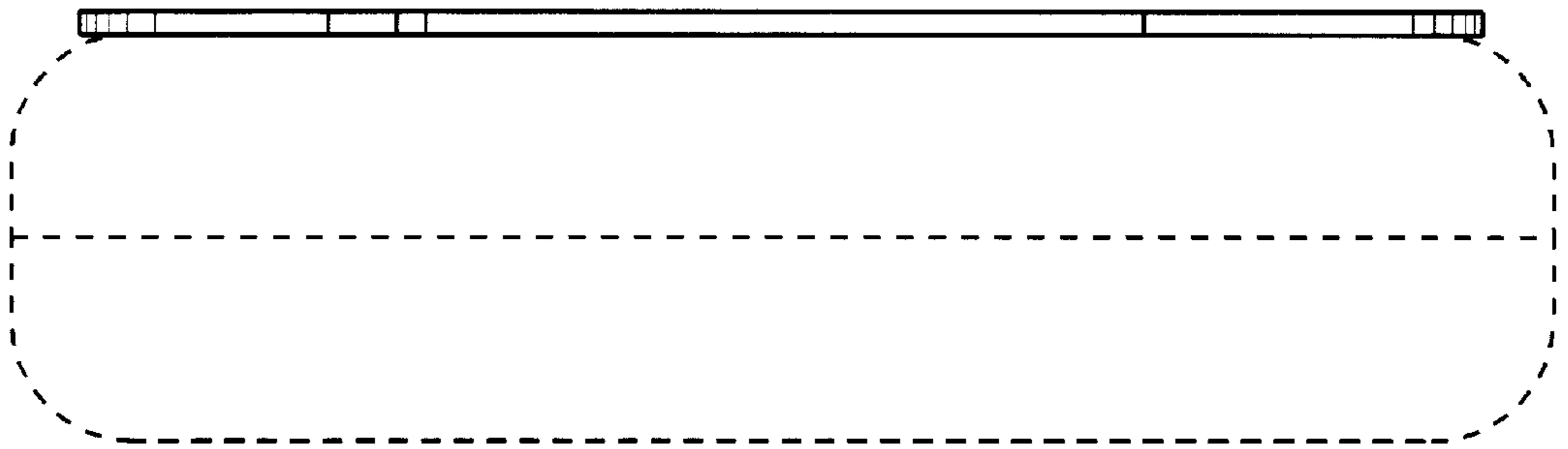


*Fig. 23*

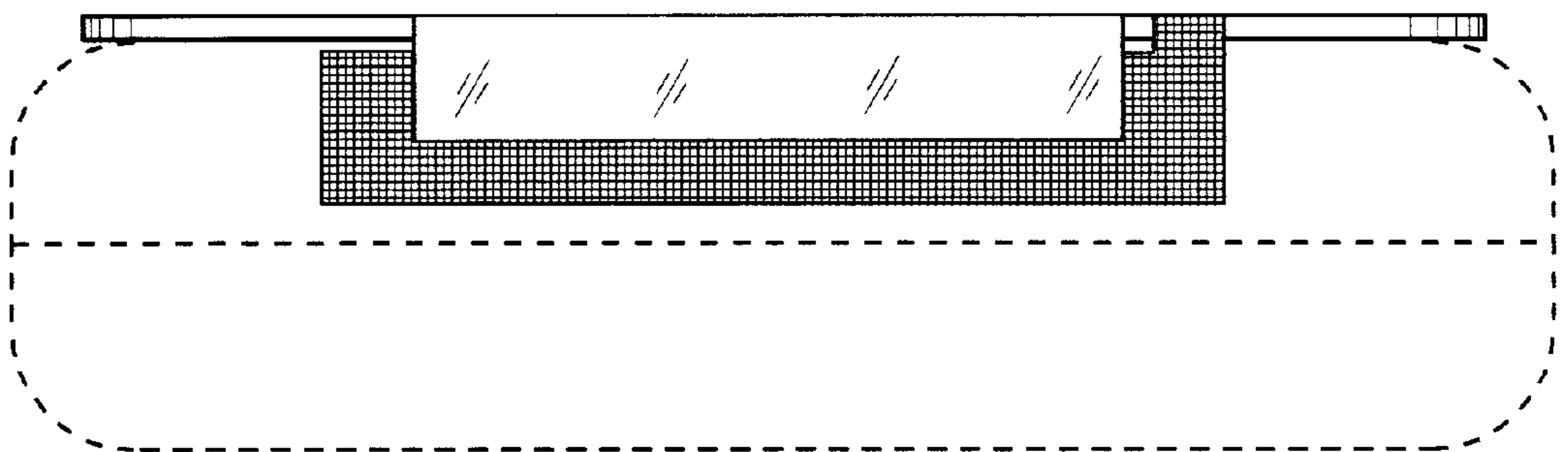


*Fig. 24*

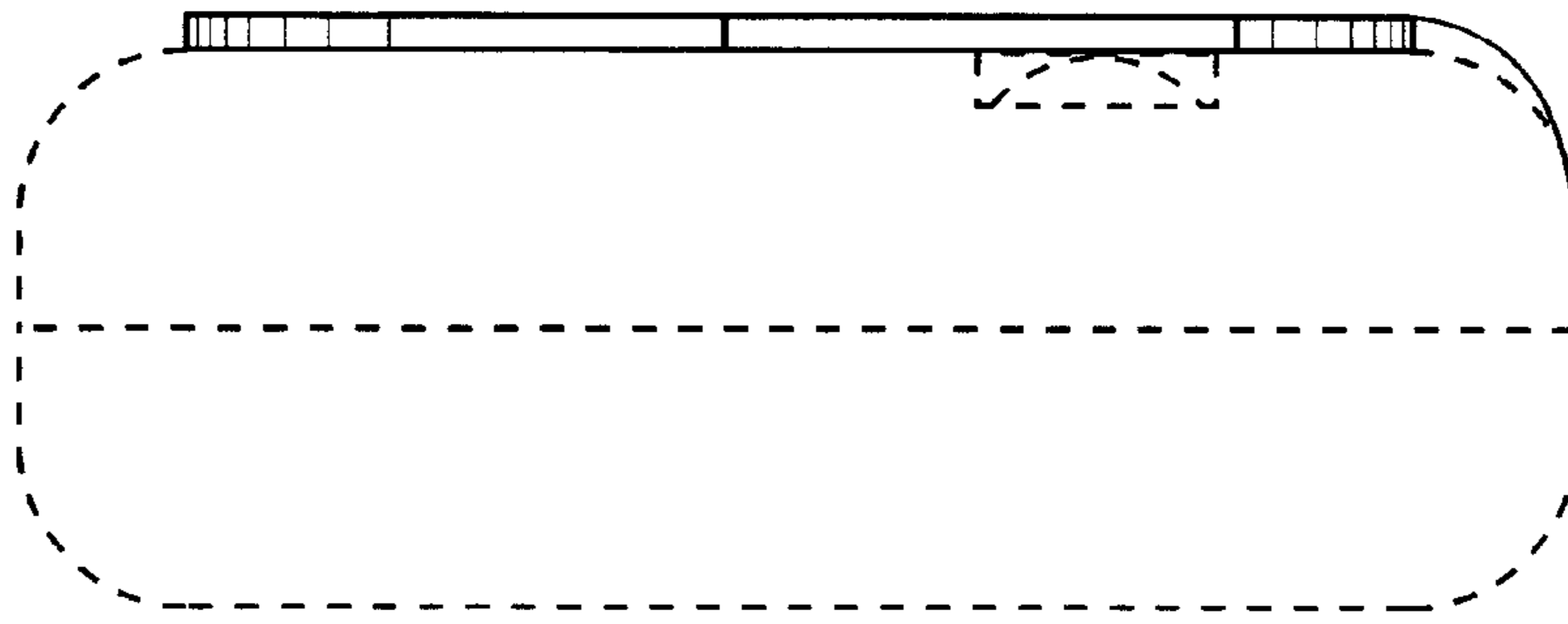




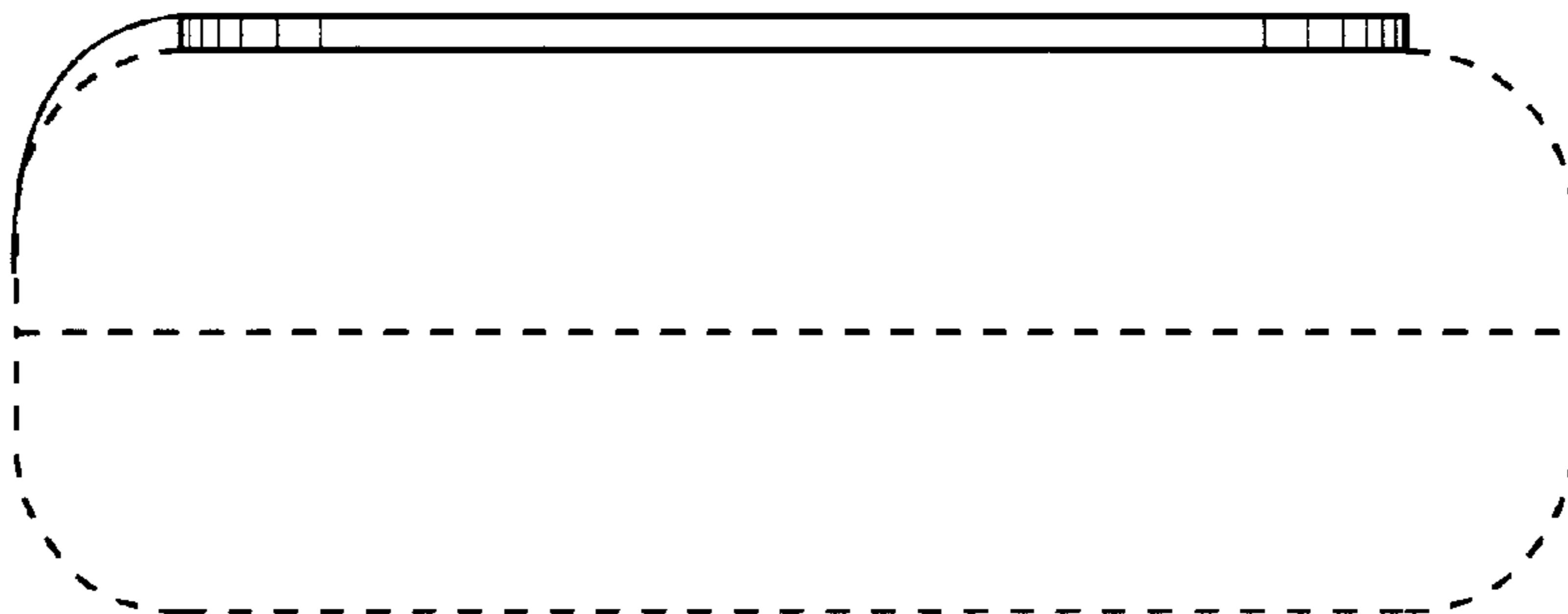
*Fig.25*



*Fig.26*



*Fig. 27*



*Fig. 28*