



US00D459337S

(12) **United States Design Patent**
Mori

(10) **Patent No.:** **US D459,337 S**

(45) **Date of Patent:** **** Jun. 25, 2002**

(54) **HEADPHONE AND RADIO RECEIVER**

(75) Inventor: **Akinari Mori**, Tokyo (JP)

(73) Assignee: **Sony Corporation**, Tokyo (JP)

(**) Term: **14 Years**

(21) Appl. No.: **29/137,710**

(22) Filed: **Feb. 28, 2001**

(51) **LOC (7) Cl.** **14-03**

(52) **U.S. Cl.** **D14/192**

(58) **Field of Search** D14/188, 192,
D14/205-206, 223; 181/129-130; 379/430,
433; 381/370, 376-381; 455/344, 347-351

(56) **References Cited**

U.S. PATENT DOCUMENTS

D346,380 S	*	4/1994	Fitzgerald	D14/206
D394,058 S	*	5/1998	Fitzgerald	D14/206 X
D411,200 S	*	6/1999	Almqvist	D14/192
D425,888 S	*	5/2000	Fitzgerald	D14/206 X

OTHER PUBLICATIONS

Home page "Sony consumer electronics guide" <http://sel.cony.com/SEL/consumer/ss5/home>, 3 sheets) Sony Corporation, (Jan. 30, 2001).

* cited by examiner

Primary Examiner—Nanda Bondade
(74) *Attorney, Agent, or Firm*—Rader, Fishman & Grauer, PLLC

(57) **CLAIM**

The ornamental design for a headphone and radio receiver, as shown and described.

DESCRIPTION

FIG. 1 is a perspective view of a headphone and radio receiver showing my new design;

FIG. 2 is a front elevational view thereof;

FIG. 3 is a rear elevational view thereof;

FIG. 4 is a left side elevational view thereof;

FIG. 5 is a right side elevational view thereof;

FIG. 6 is a top plan view thereof; and,

FIG. 7 is a bottom plan view thereof.

The portions in broken lines are for illustrative purposes only and form no part of the claimed design.

1 Claim, 4 Drawing Sheets

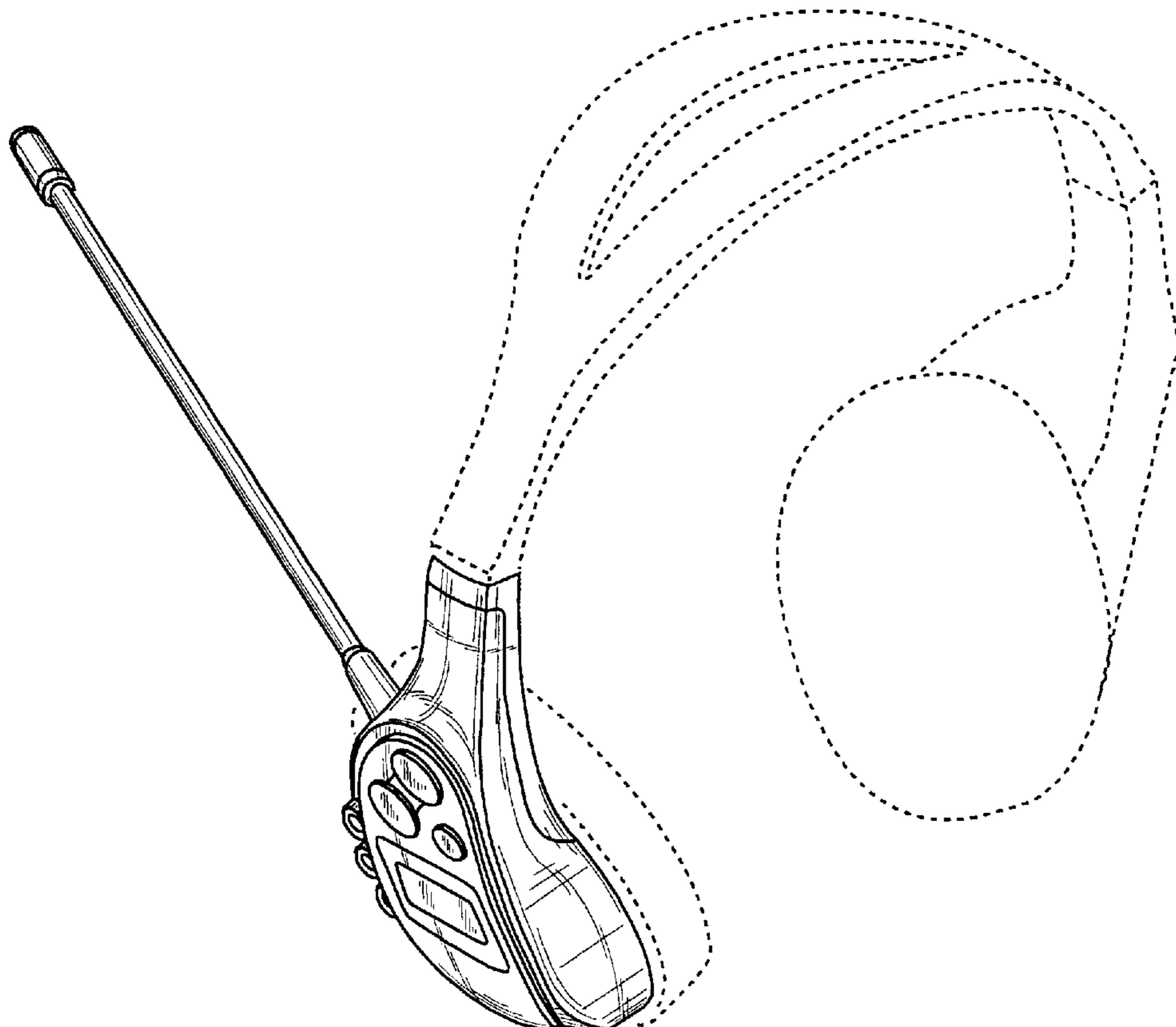

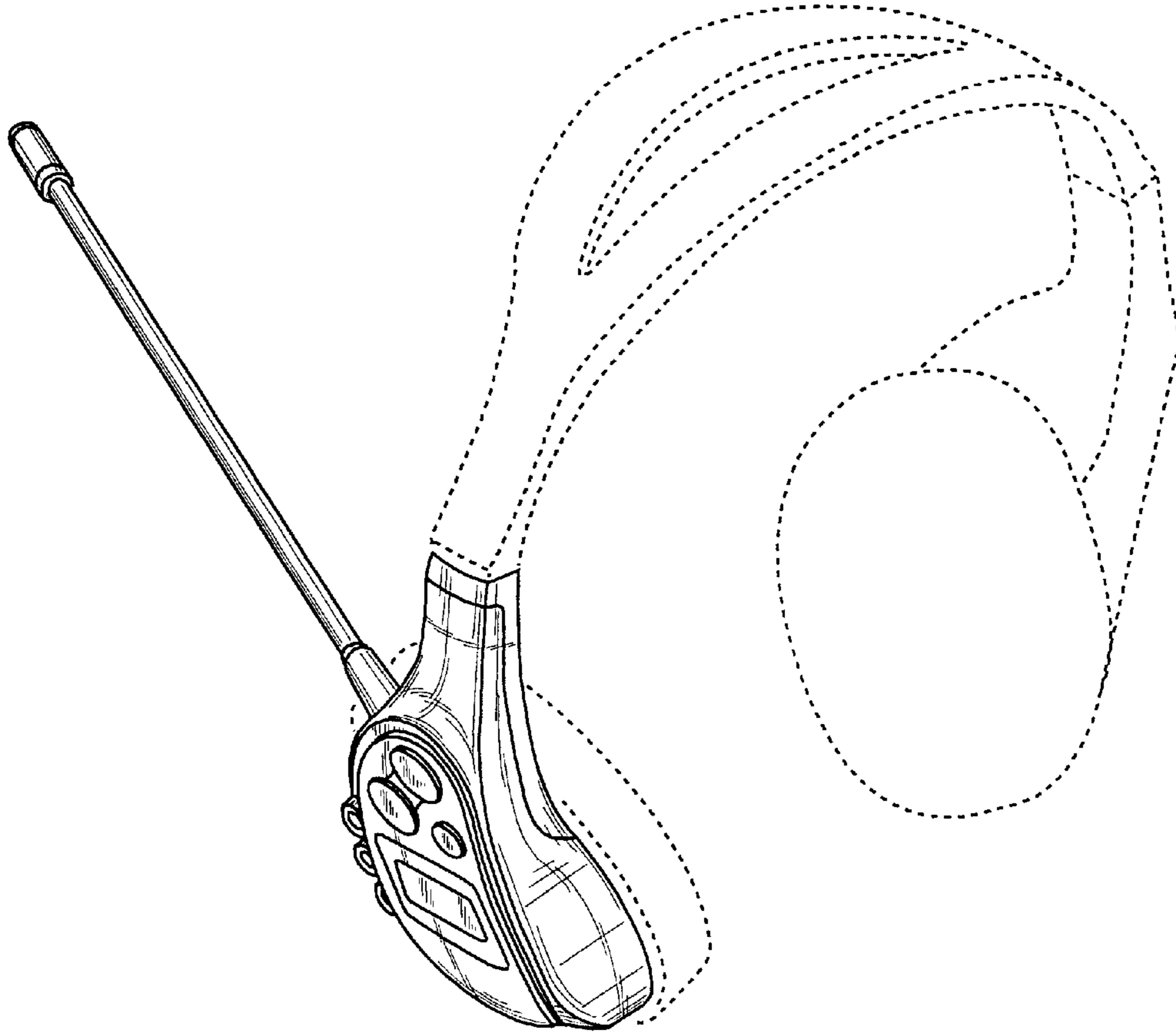

Fig. 1

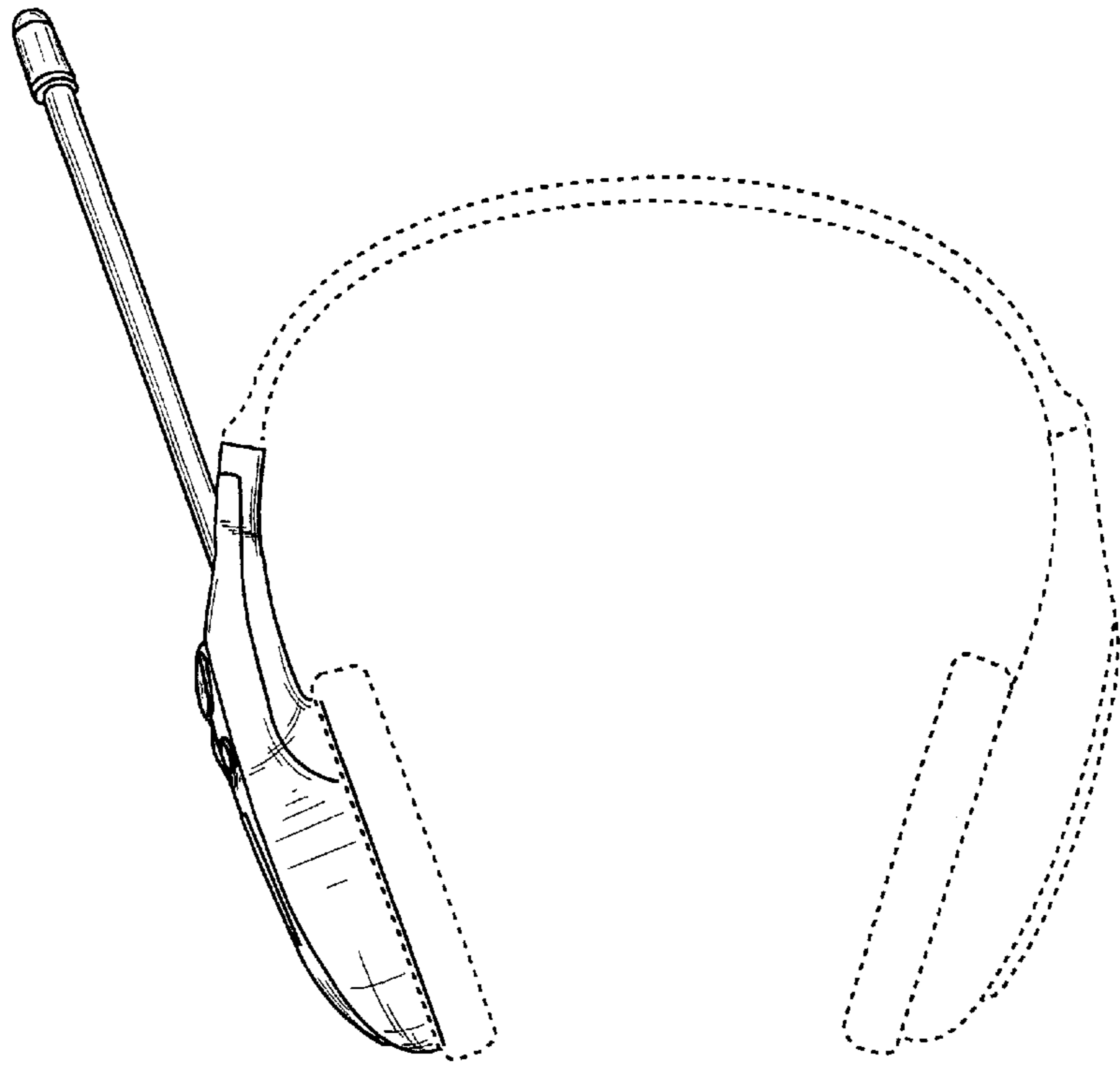

Fig. 2

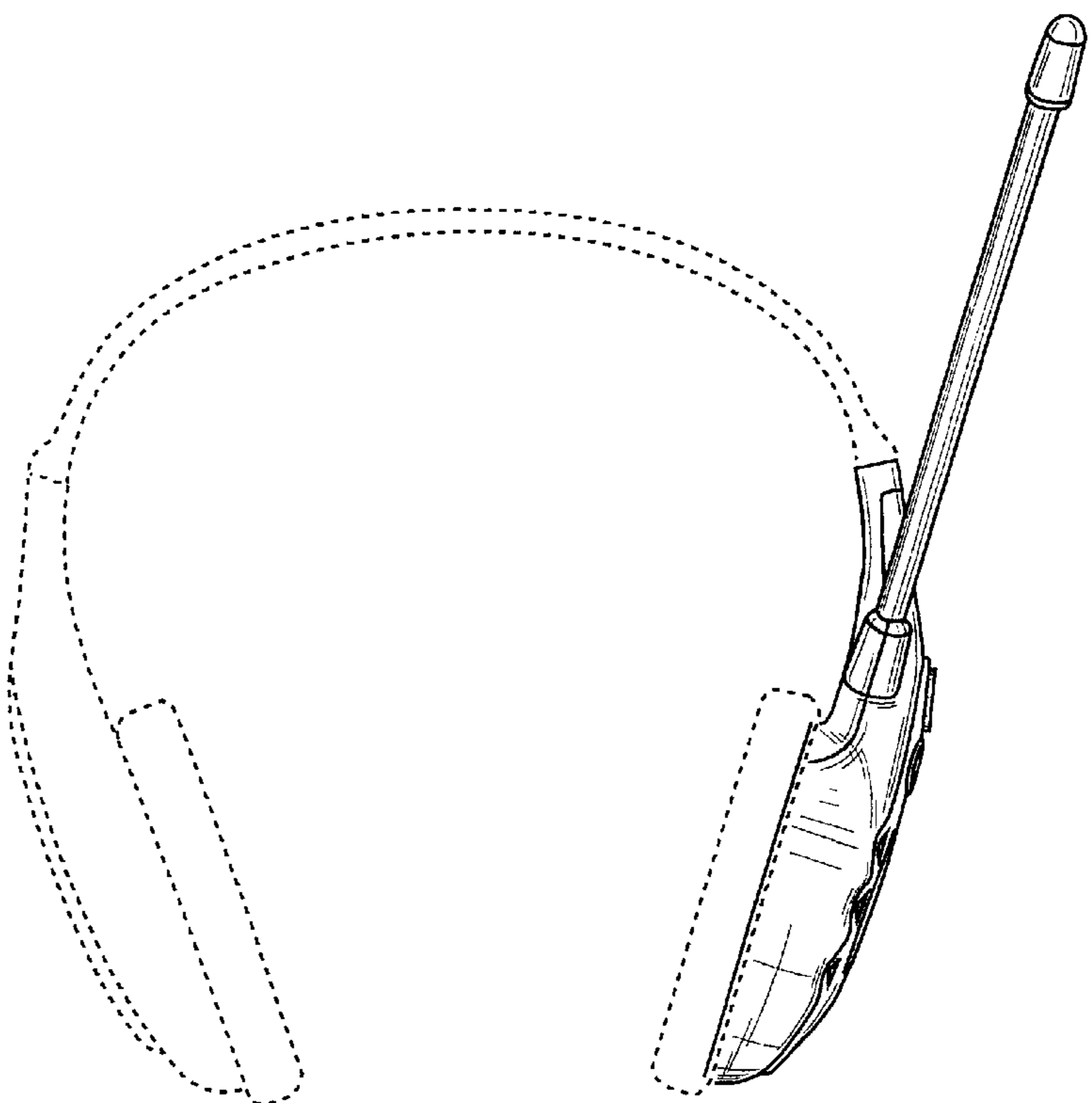

Fig. 3

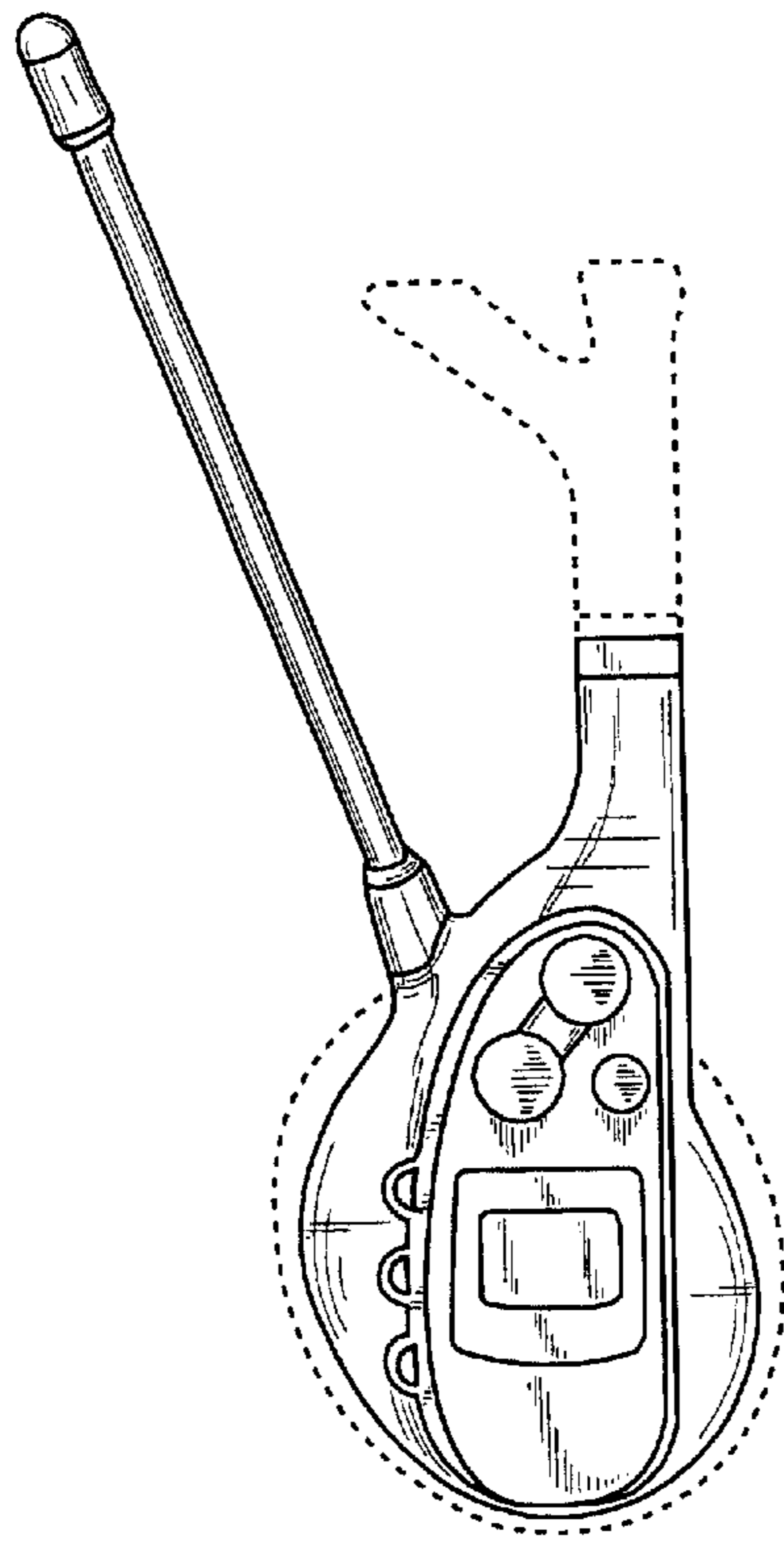

Fig. 4

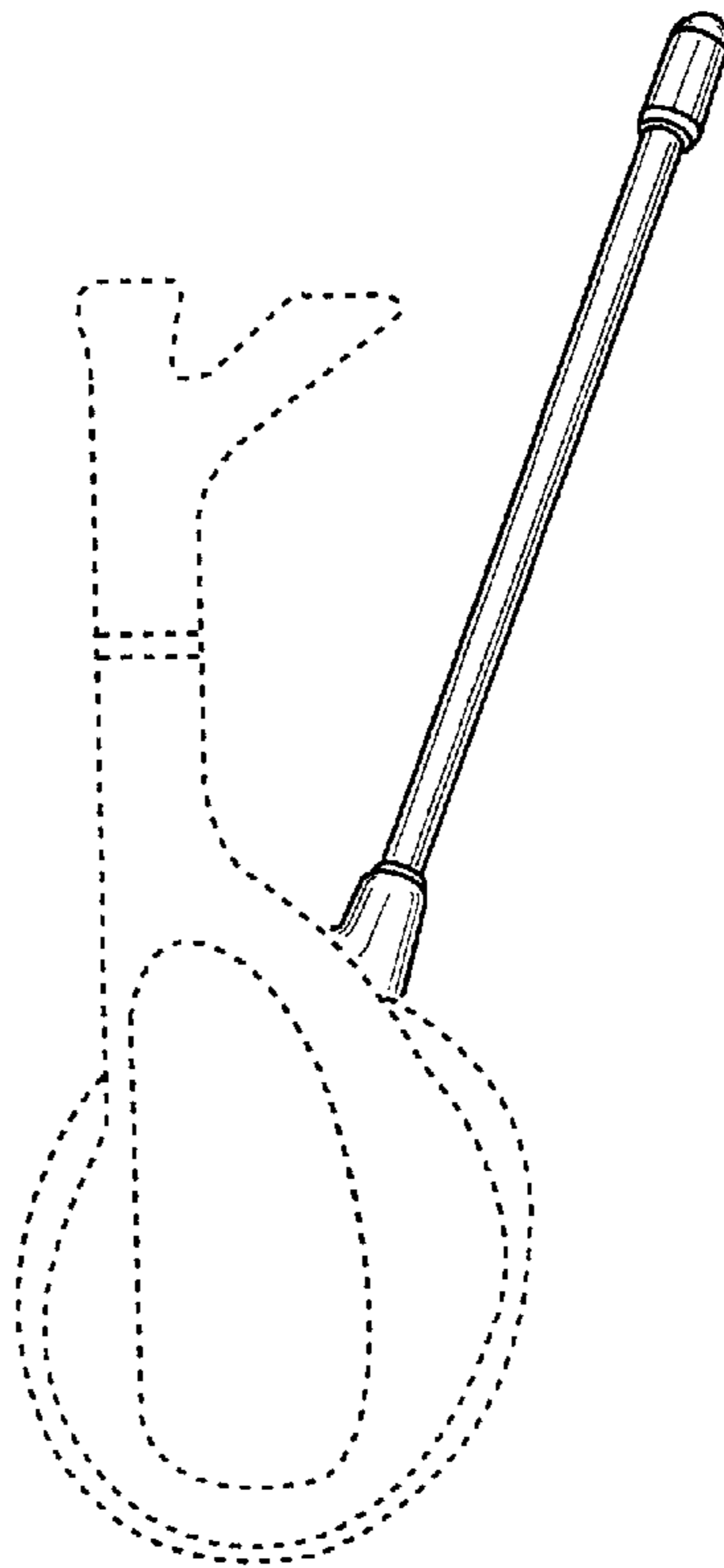

Fig. 5

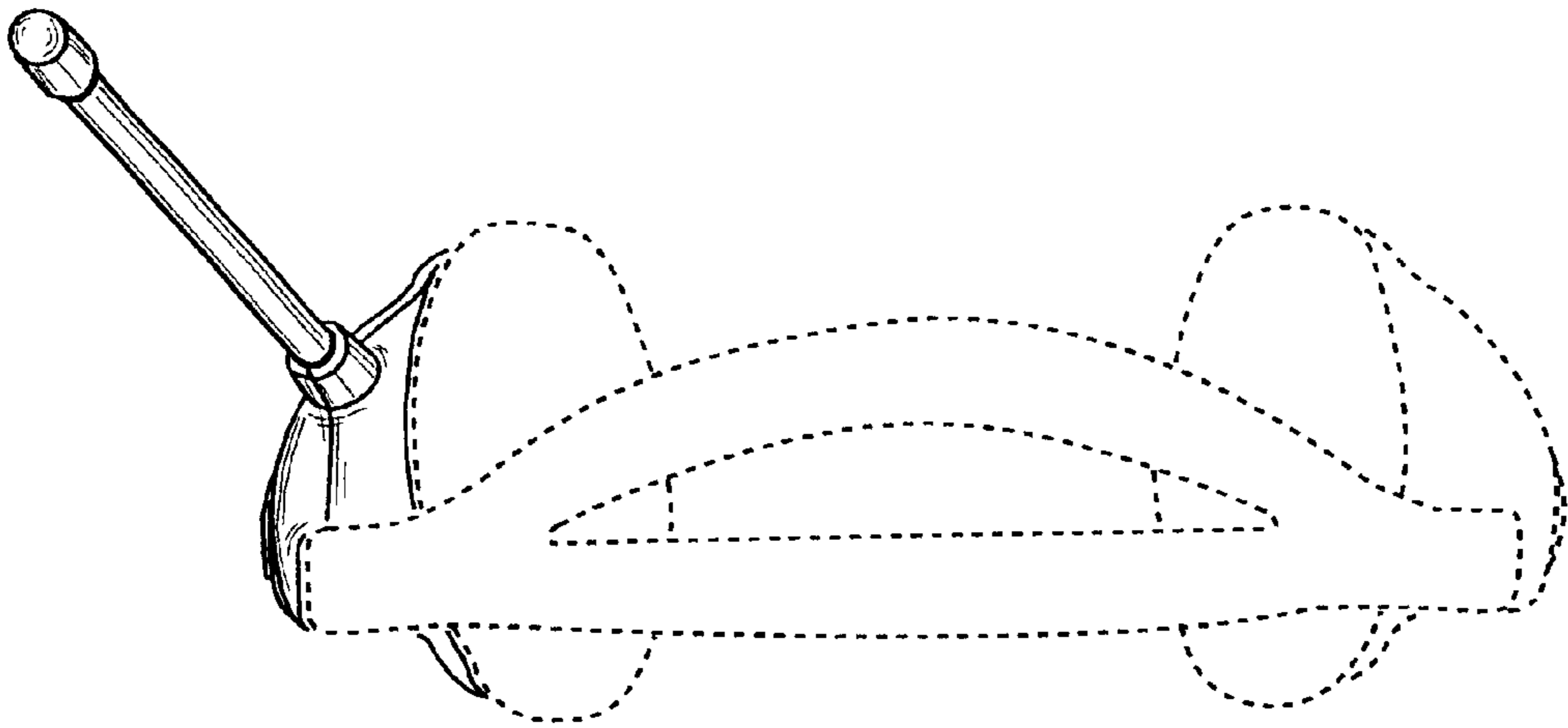

Fig. 6

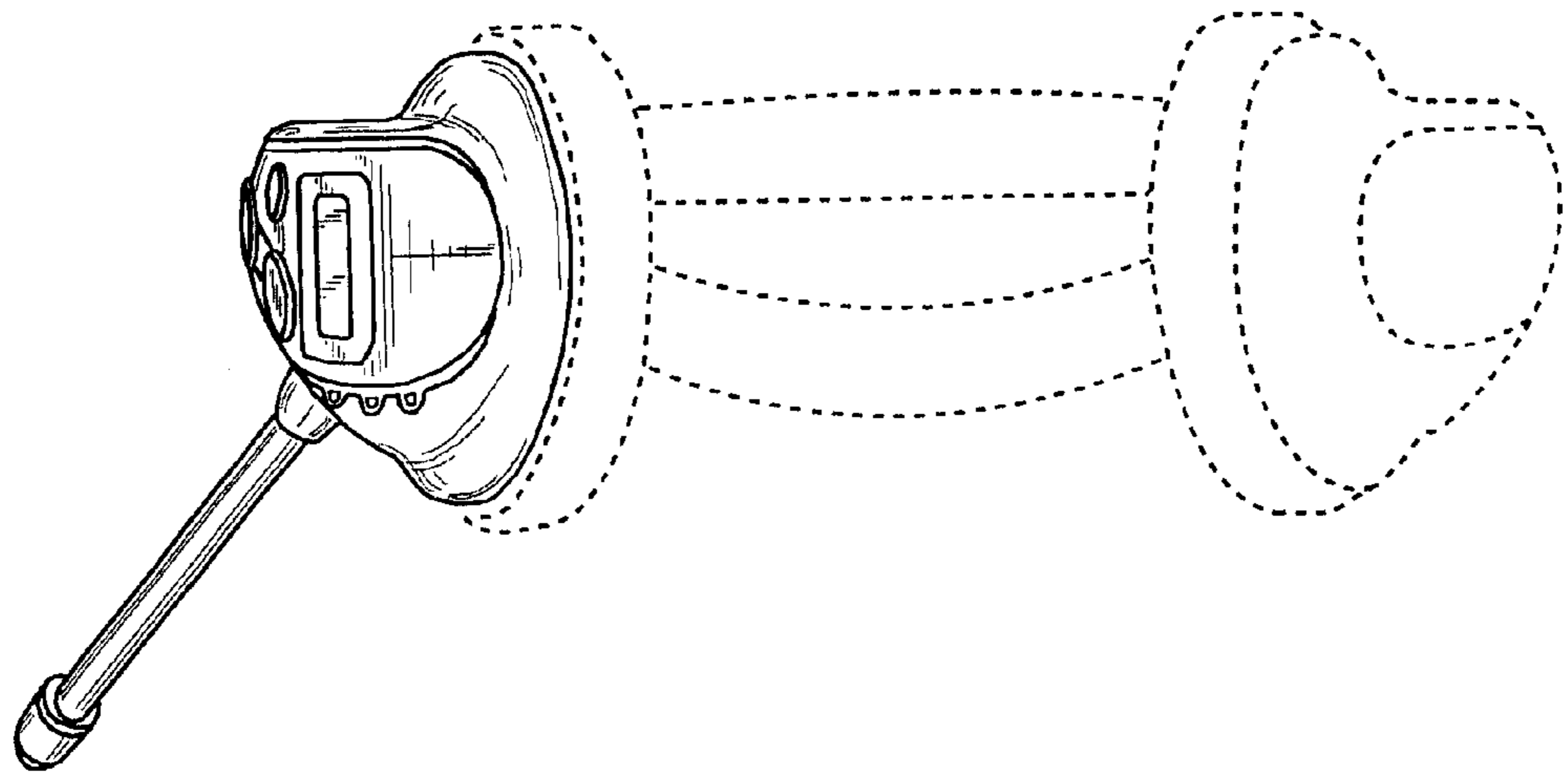

Fig. 7