



US00D459275S

(12) **United States Design Patent**
Price

(10) **Patent No.:** **US D459,275 S**

(45) **Date of Patent:** **** Jun. 25, 2002**

(54) **DECORATIVE ACCESSORY FOR
MOTORCYCLE SIDE BAGS**

(76) Inventor: **Stephen A. Price**, 10623 Shadow La.,
Fairfax Station, VA (US) 22039

(**) Term: **14 Years**

(21) Appl. No.: **29/146,976**

(22) Filed: **Aug. 20, 2001**

(51) **LOC (7) Cl.** **12-11**

(52) **U.S. Cl.** **D12/114**

(58) **Field of Search** D12/110, 114,
D12/407, 409, 410, 223; 280/288.4, 304.3;
180/219; 224/413, 419-435, 441-443, 447-449,
457; 248/302, 311.2

(56) **References Cited**
PUBLICATIONS

Harley-Davidson ® 1999 Genuine Motor Accessories™ &
Genuine Motor Parts™ catalog, saddlebag top trim on p.
255.*

JC Whitney™ Spring 1999 Motorcycle accessories and
parts catalog, travel trunk side trim on the Honda Gold Wing
® on p. 10.*

* cited by examiner

Primary Examiner—Alan P. Douglas

Assistant Examiner—Linda Brooks

(74) *Attorney, Agent, or Firm*—Dennis H. Lambert

(57) **CLAIM**

I claim the ornamental design for a decorative accessory for
motorcycle side bags, as shown and described.

DESCRIPTION

FIG. 1 is a top perspective view of my design for a
decorative accessory for motorcycle side bags.

FIG. 2 is a right side view in elevation of the design.

FIG. 3 is a top plan view of the design.

FIG. 4 is a front end view in elevation of the design.

FIG. 5 is left side view in elevation of the design.

FIG. 6 is a rear end view in elevation of the design.

FIG. 7 is a transverse cross-sectional view taken along line
7—7 in FIG. 4; and,

FIG. 8 is a transverse cross-sectional view taken along line
8—8 in FIG. 3.

The broken line showing of environment is for illustrative
purposes only and forms no part of the claimed invention.

1 Claim, 3 Drawing Sheets

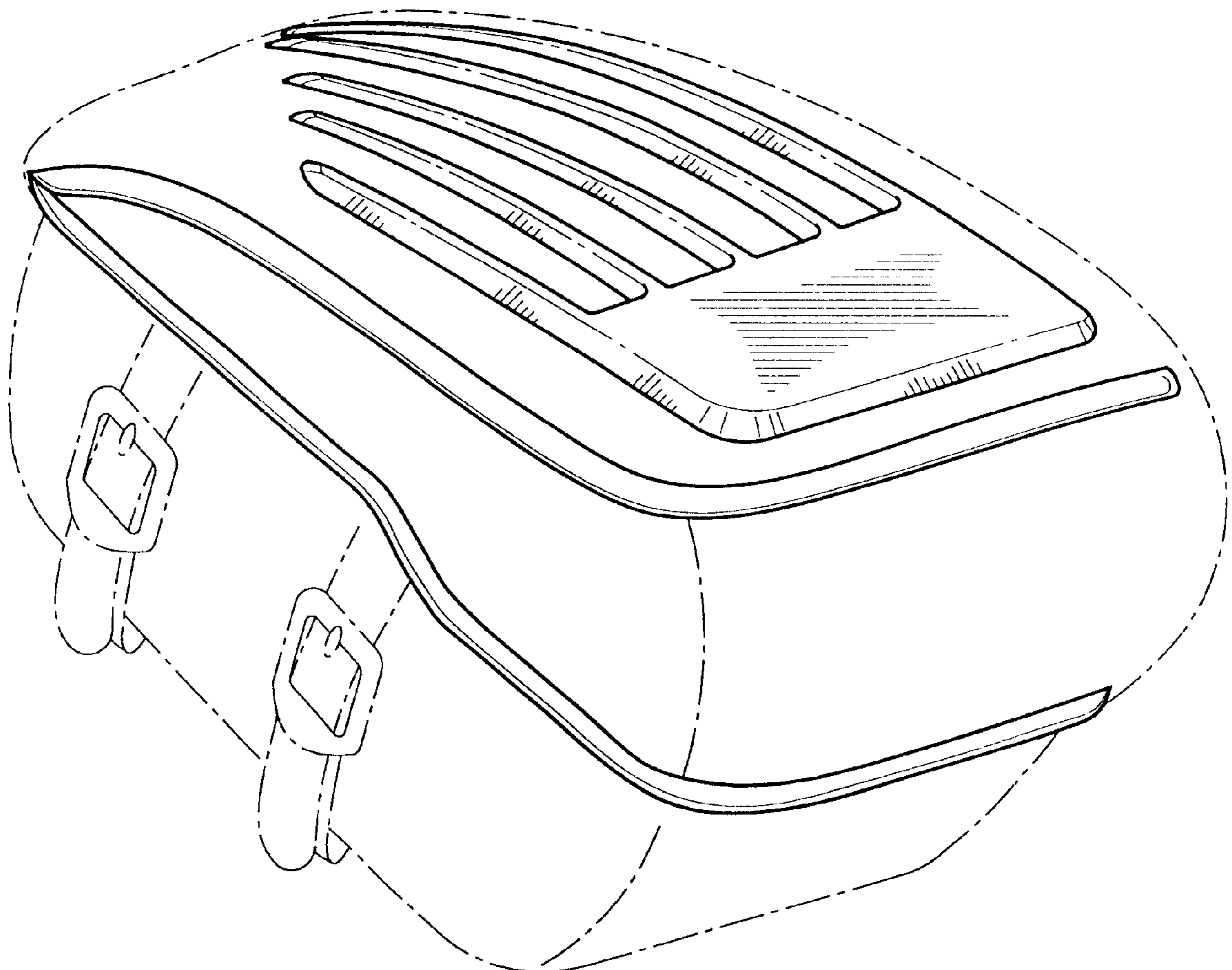

FIG.1

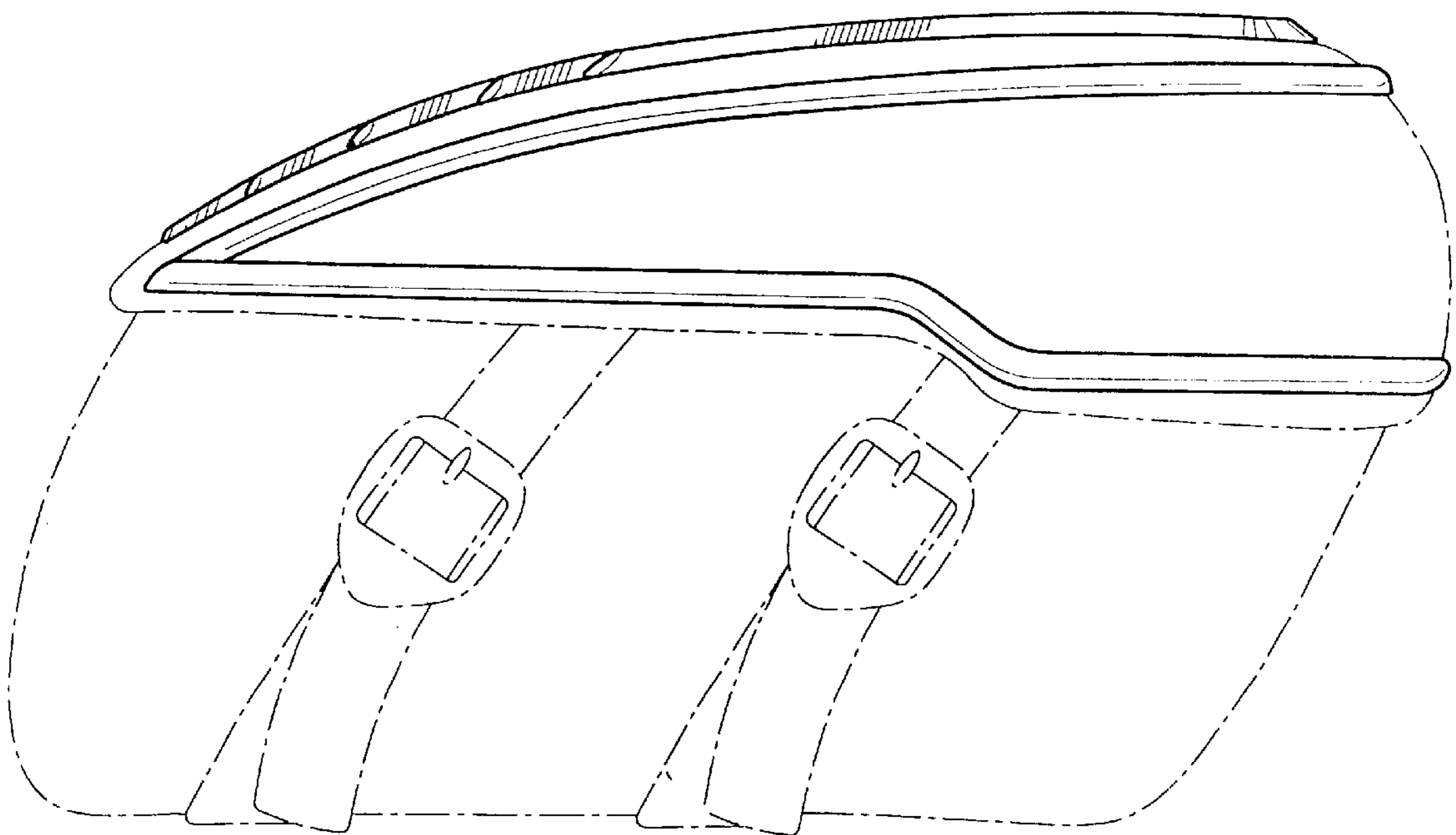
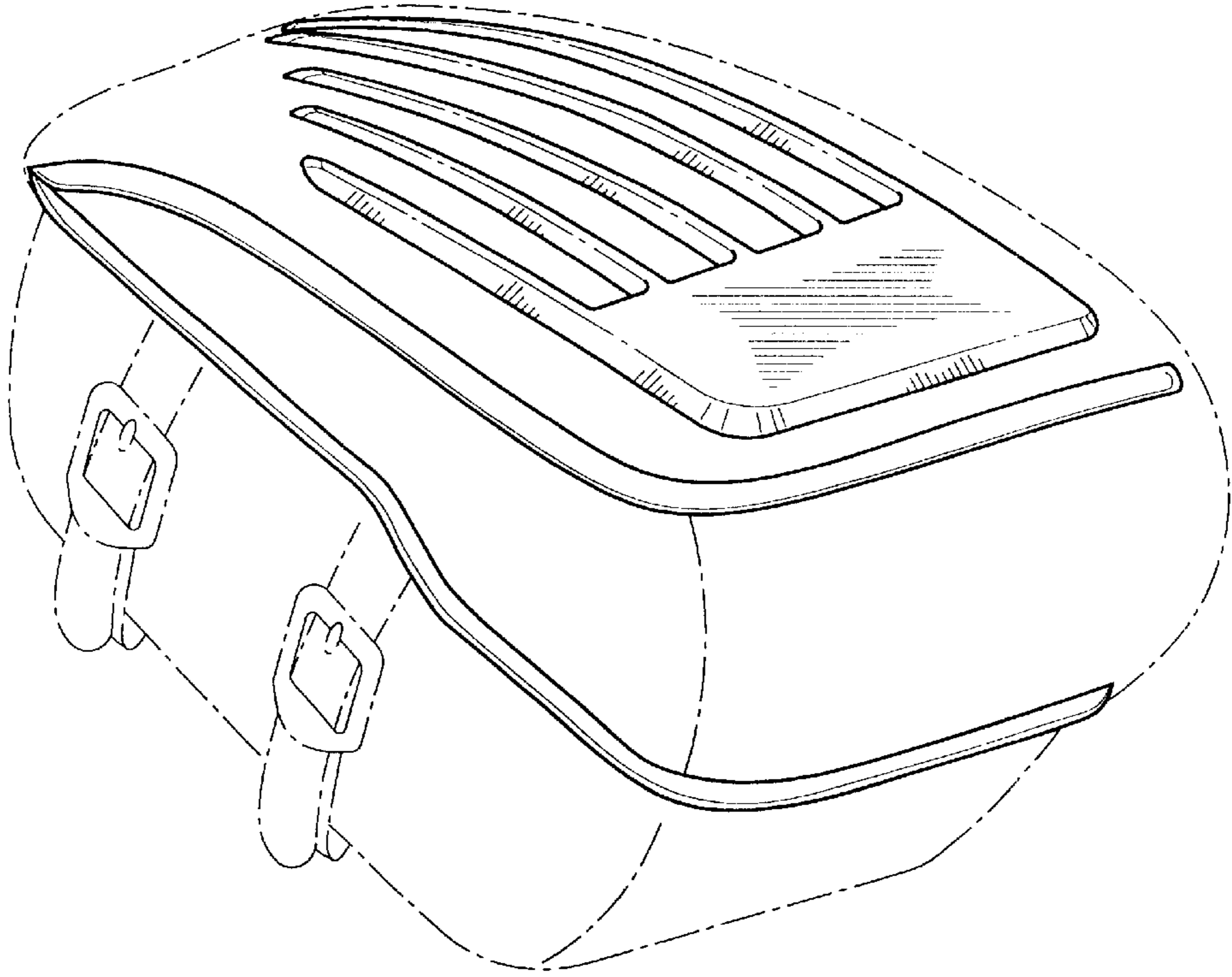

FIG.2

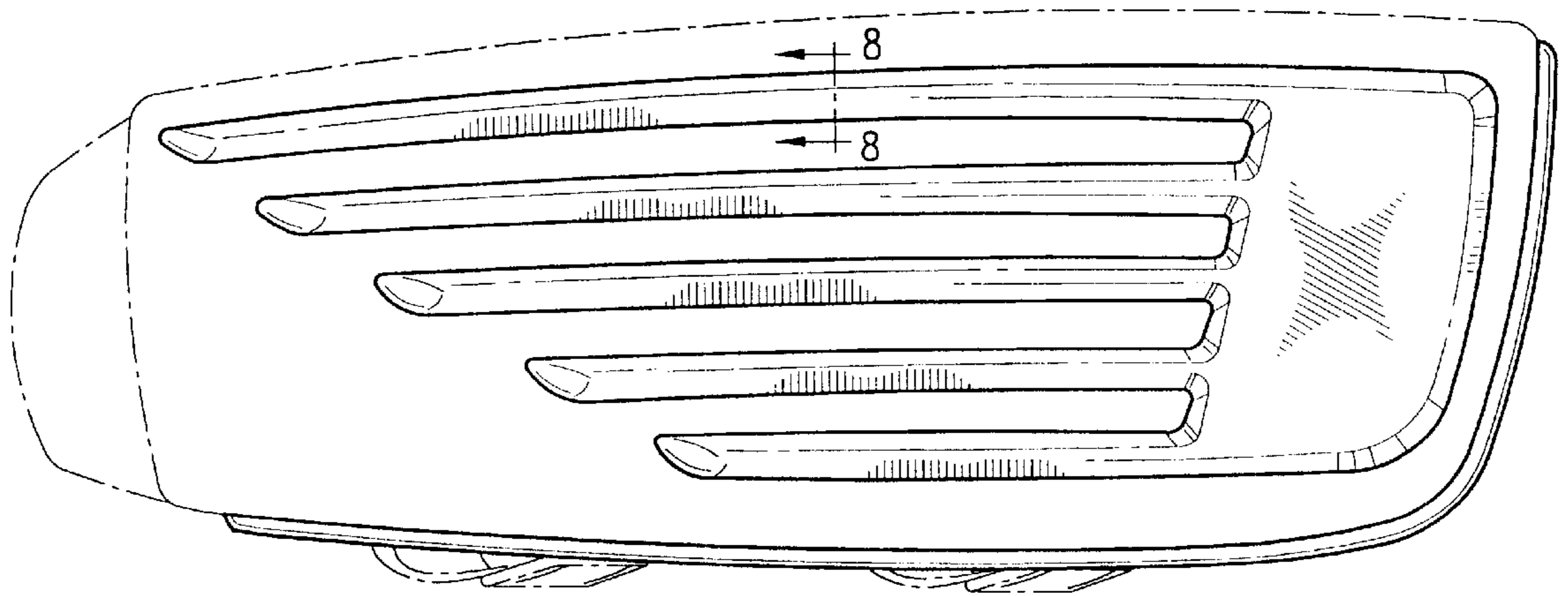

FIG.3

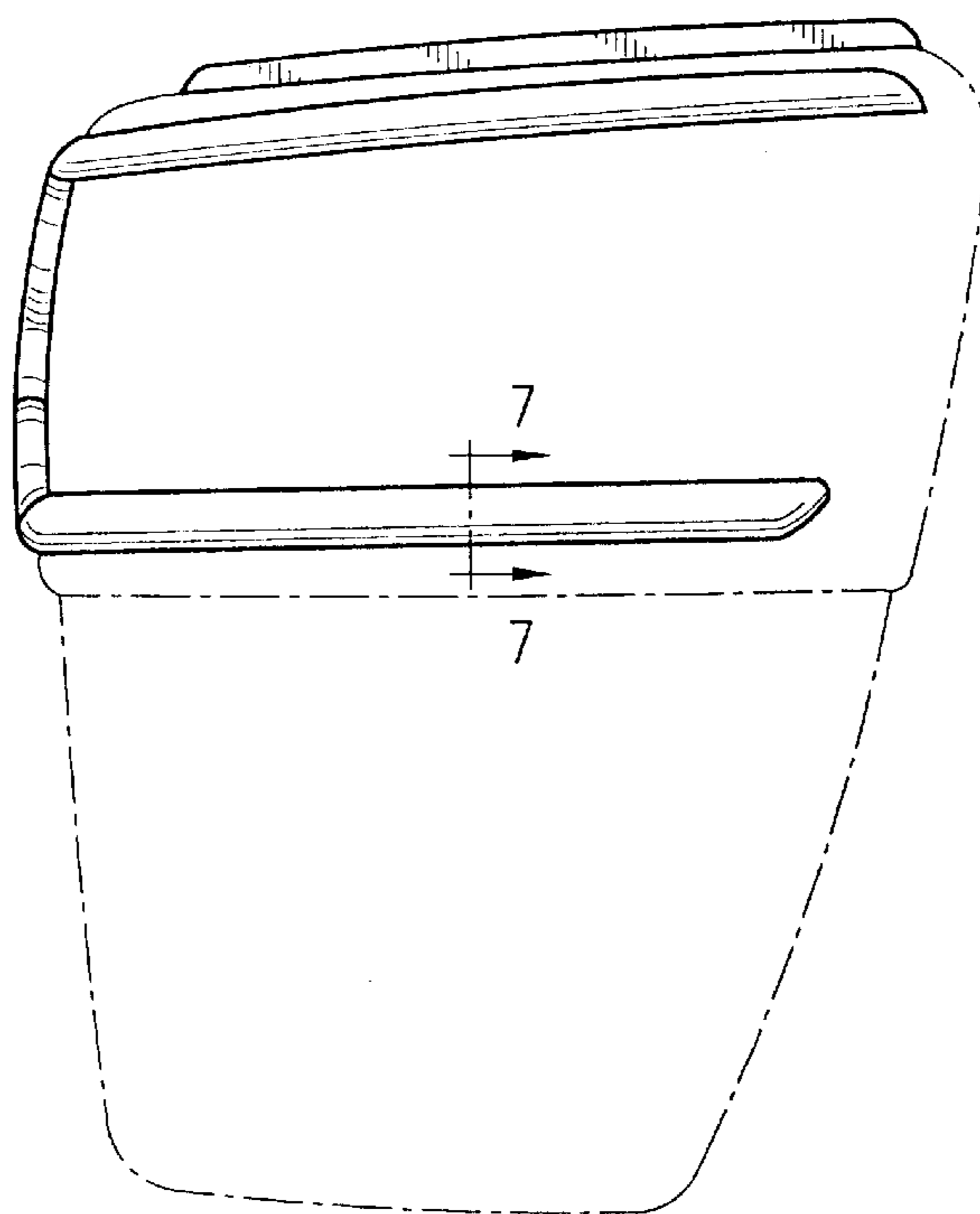

FIG.4

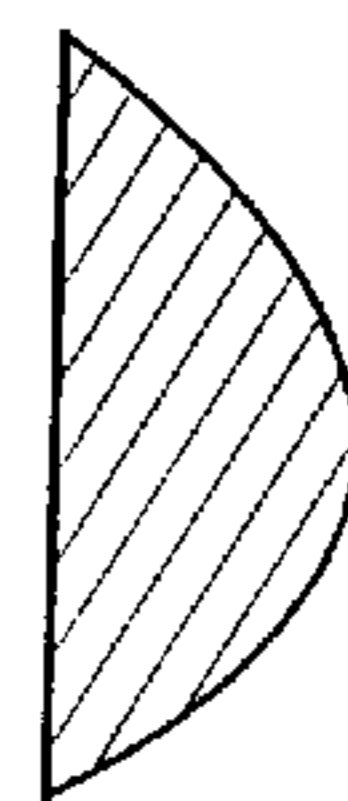

FIG.7

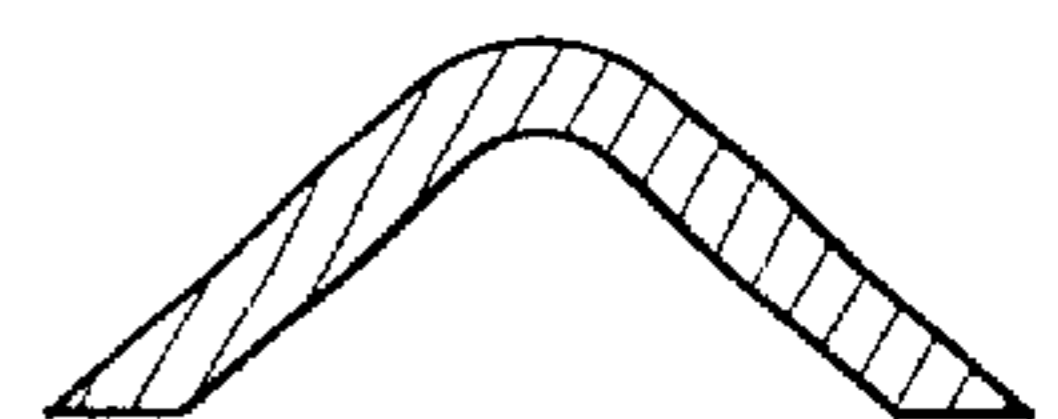

FIG.8

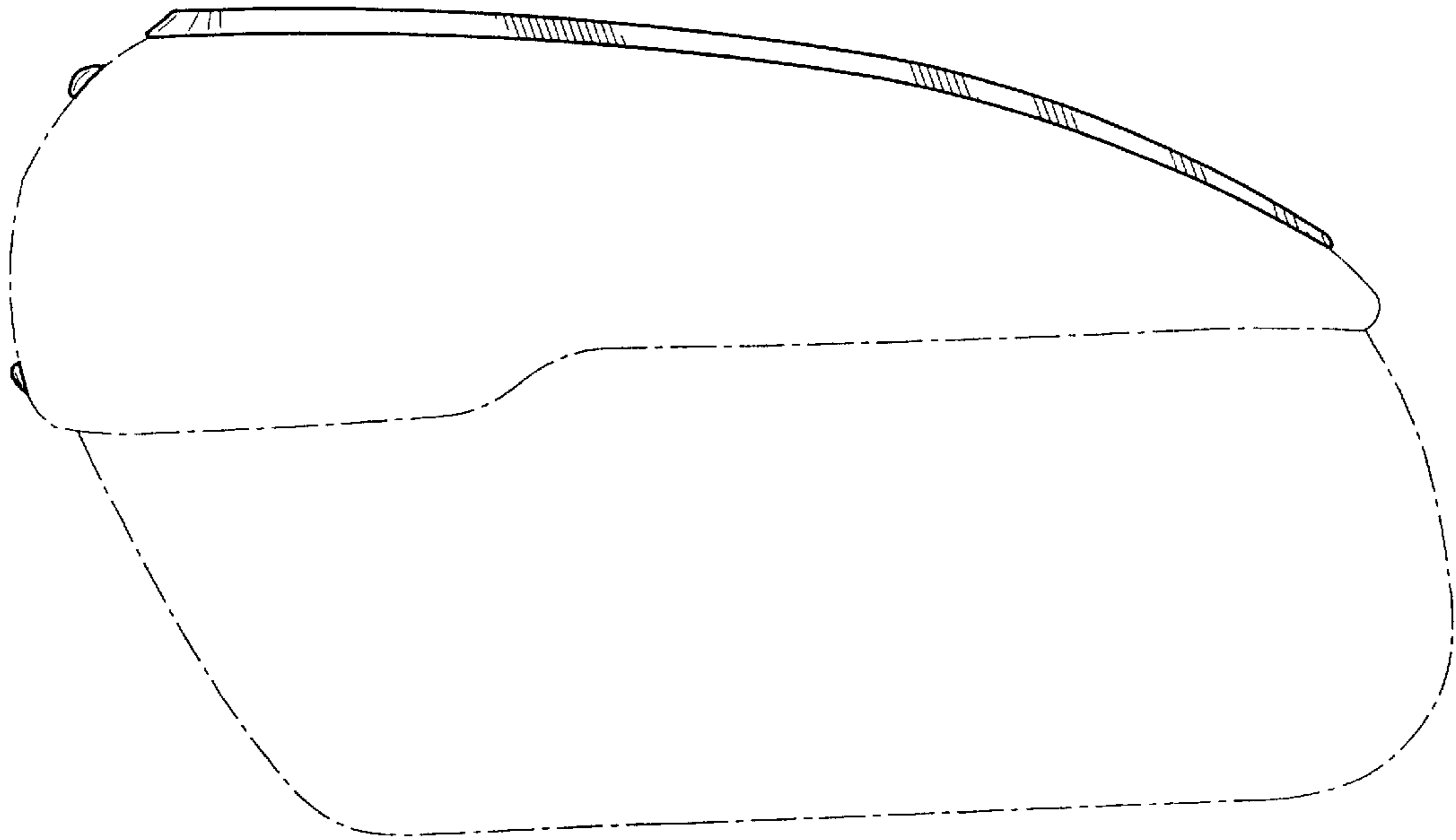

FIG. 5

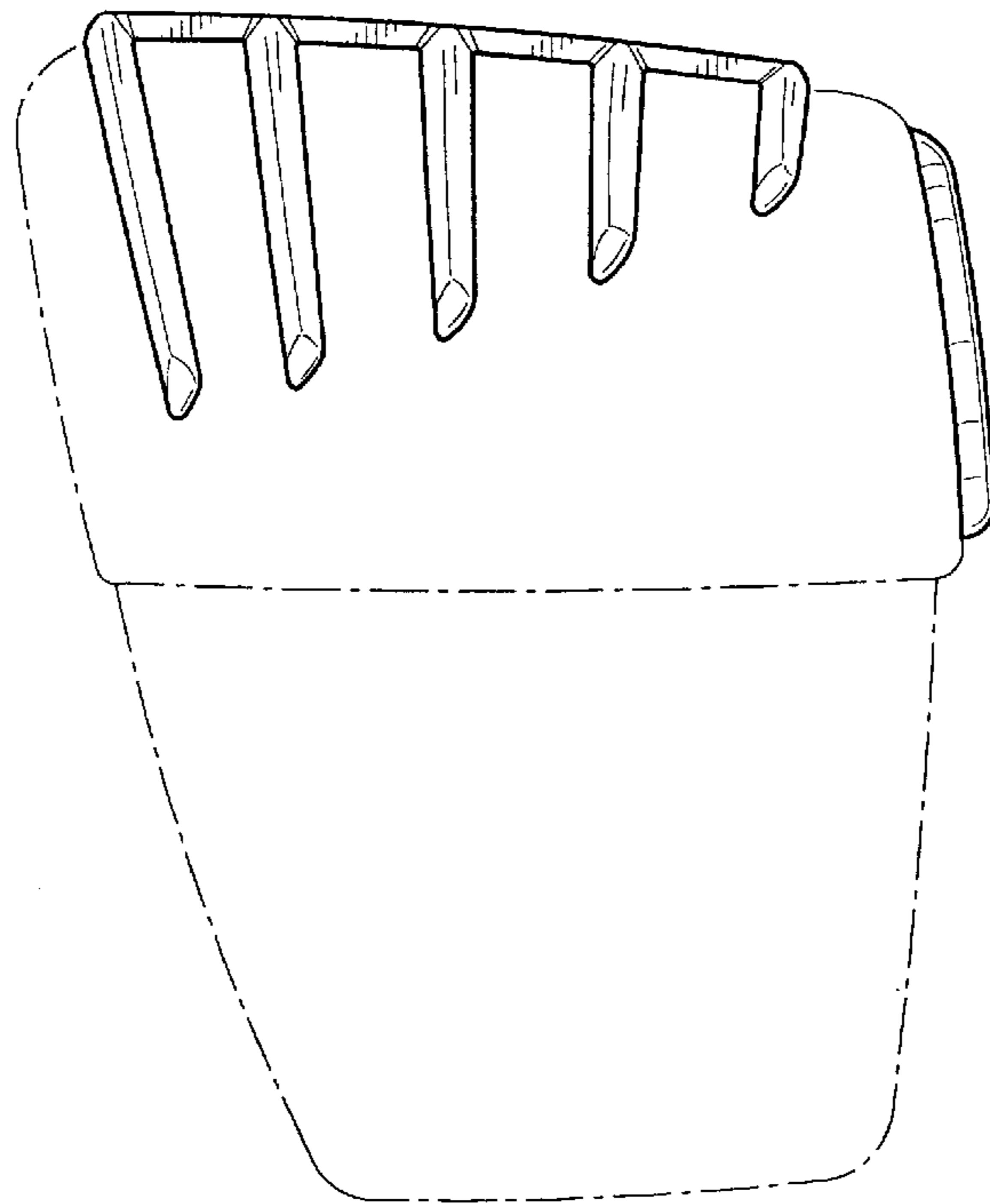

FIG. 6