



US00D459214S

(12) **United States Design Patent**  
**Buboltz et al.**

(10) **Patent No.:** **US D459,214 S**  
(45) **Date of Patent:** **\*\* Jun. 25, 2002**

(54) **EYE BOTTLE**

(75) Inventors: **Jerome B. Buboltz**, Hartford; **David Madenberg**, Nashotah, both of WI (US)

(73) Assignee: **Body Bottles, LLC**, Hartland, WI (US)

(\*\*) Term: **14 Years**

(21) Appl. No.: **29/143,734**

(22) Filed: **Jun. 19, 2001**

(51) **LOC (7) Cl.** ..... **09-01**

(52) **U.S. Cl.** ..... **D9/314**

(58) **Field of Search** ..... D9/307, 311, 314;  
D11/117, 121, 125, 128

(56) **References Cited**

**U.S. PATENT DOCUMENTS**

D321,823 S \* 11/1991 Guignard ..... D9/314

**OTHER PUBLICATIONS**

Oriental Trading Co., Sep. 1997, p. 19, eyeball kick ball, lower, right corner.\*

\* cited by examiner

*Primary Examiner*—Terry A. Wallace

(74) *Attorney, Agent, or Firm*—Cook & Franke SC

(57) **CLAIM**

The ornamental design for an eye bottle, as shown and described.

**DESCRIPTION**

FIG. 1 is a perspective view of a bottle showing our new design;

FIG. 2 is a right side view thereof;

FIG. 3 is a bottom plan view of the design of FIG. 2;

FIG. 4 is a top plan view of the design of FIG. 2;

FIG. 5 is a front plan view of the design of FIG. 2; and,

FIG. 6 is a back plan view of the design of FIG. 2.

The broken lines shown in all figures are for illustrative purposes only and form no part of the claimed design.

**1 Claim, 3 Drawing Sheets**

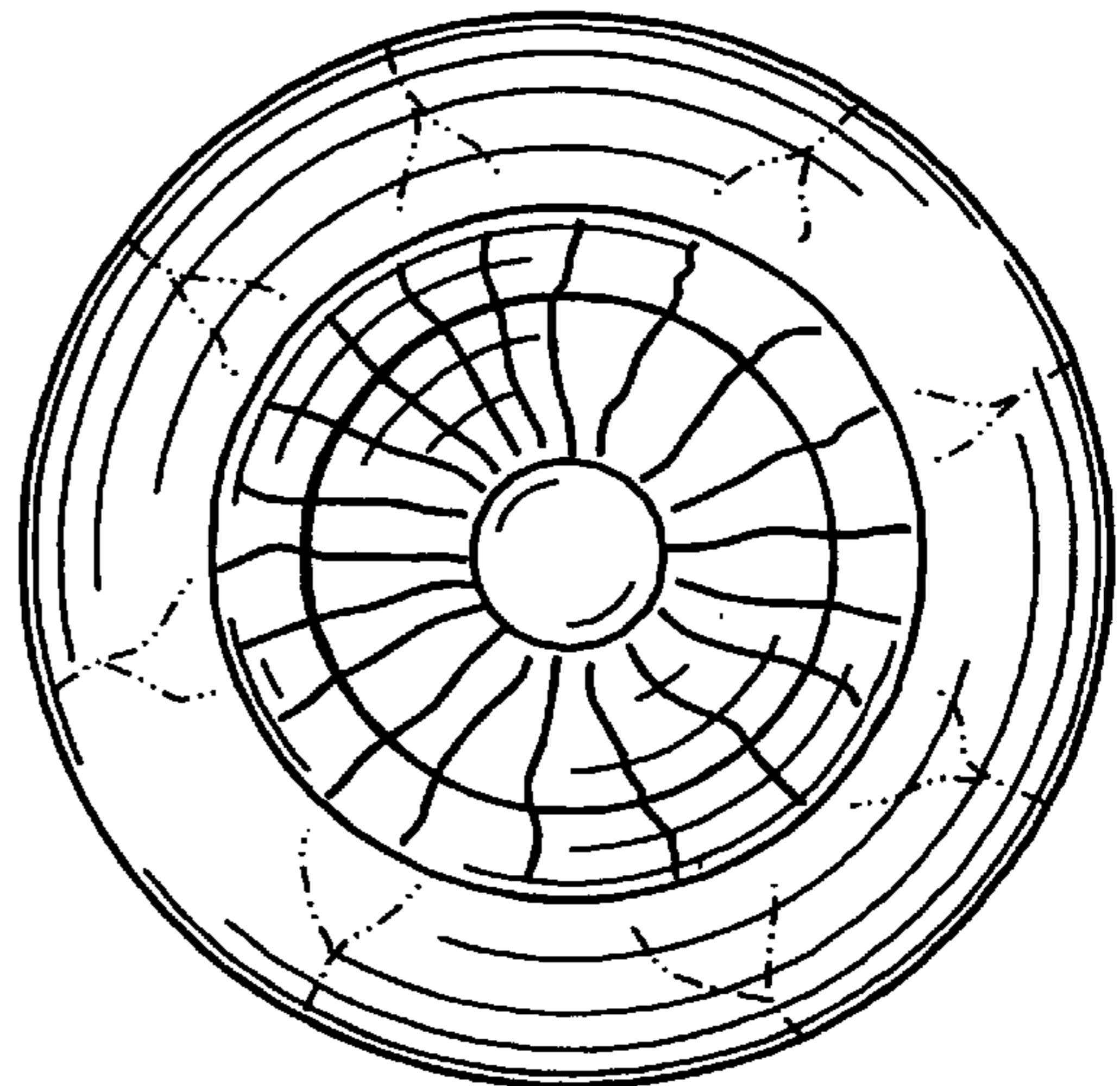
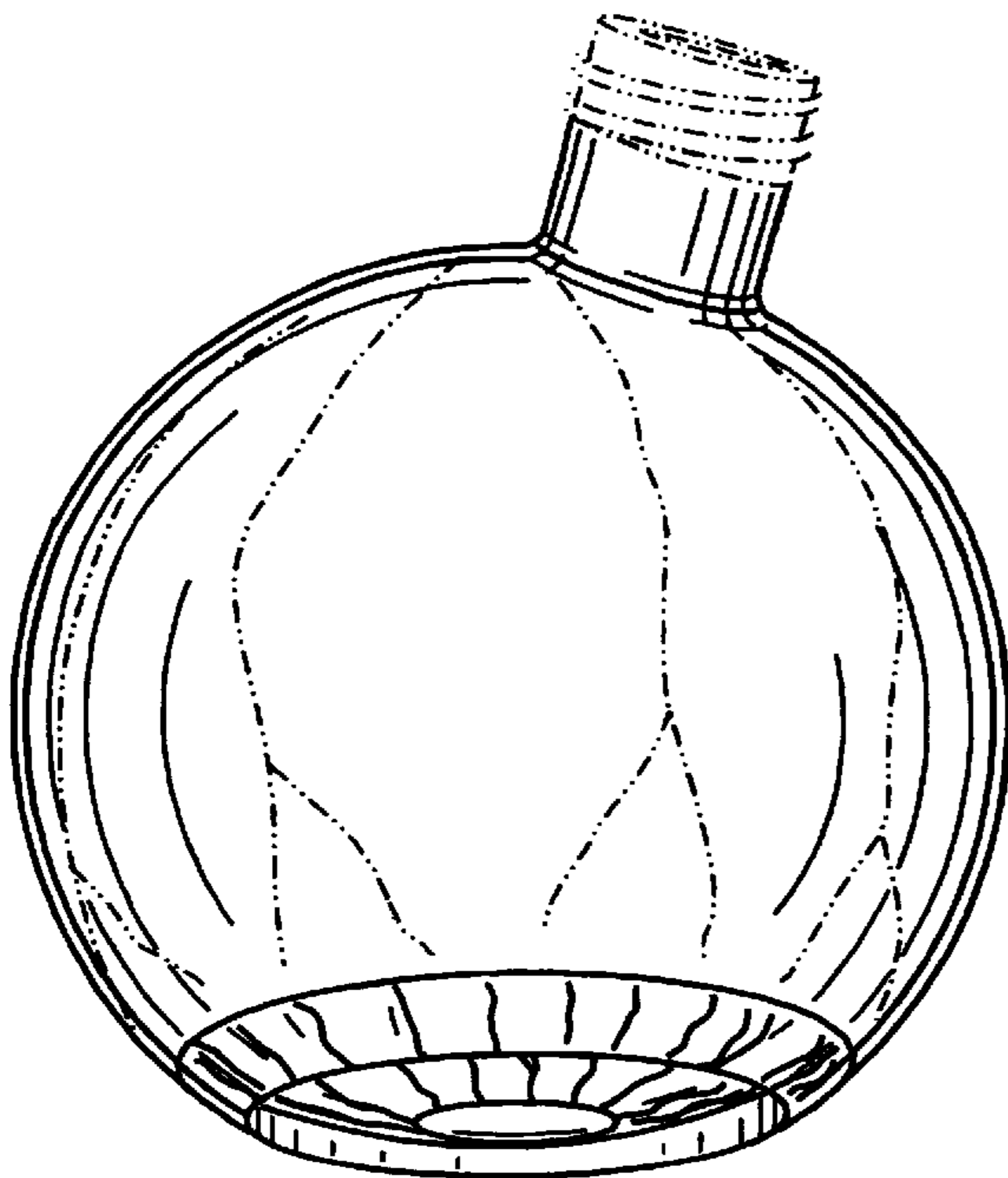

FIG. 1

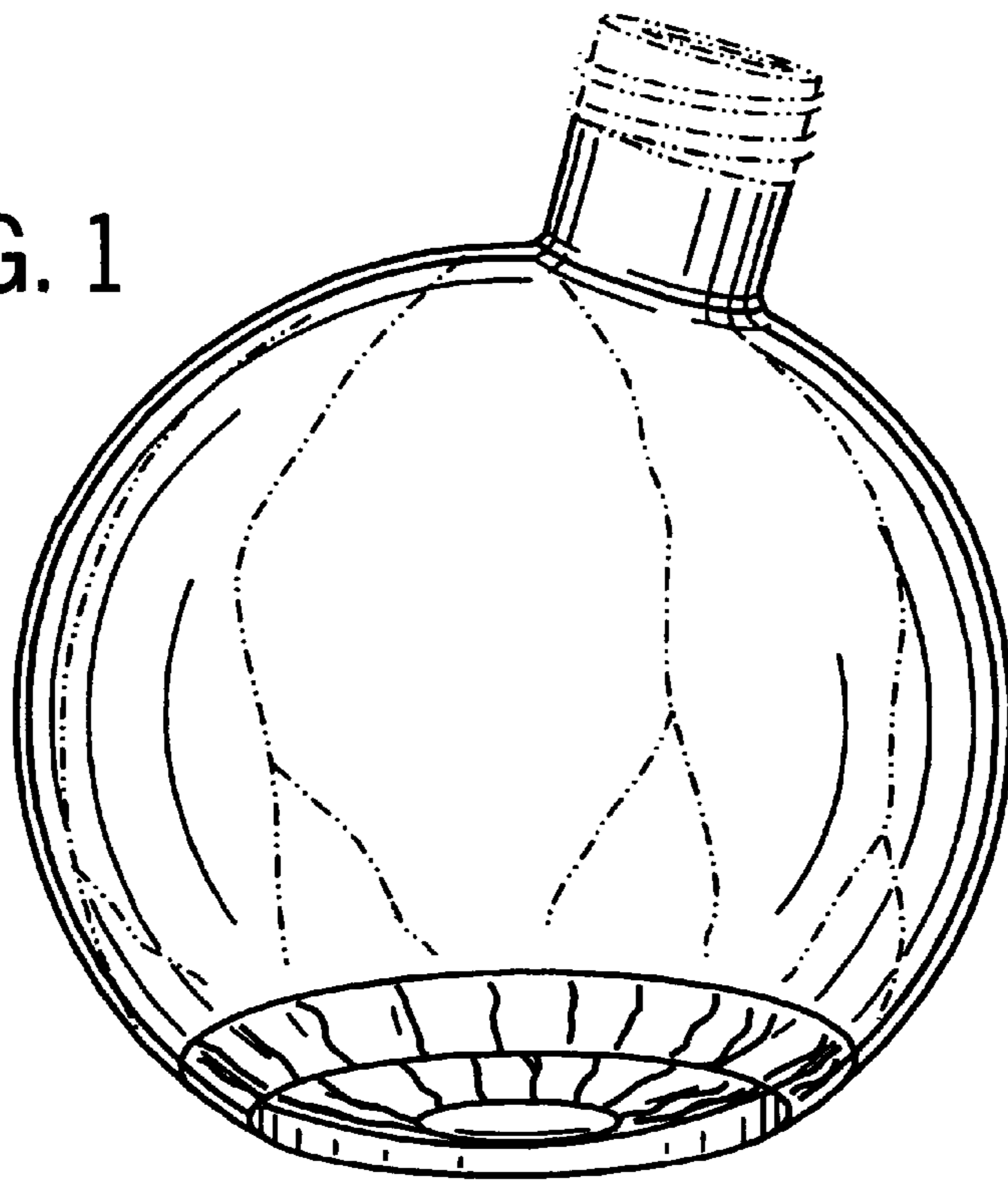

FIG. 2

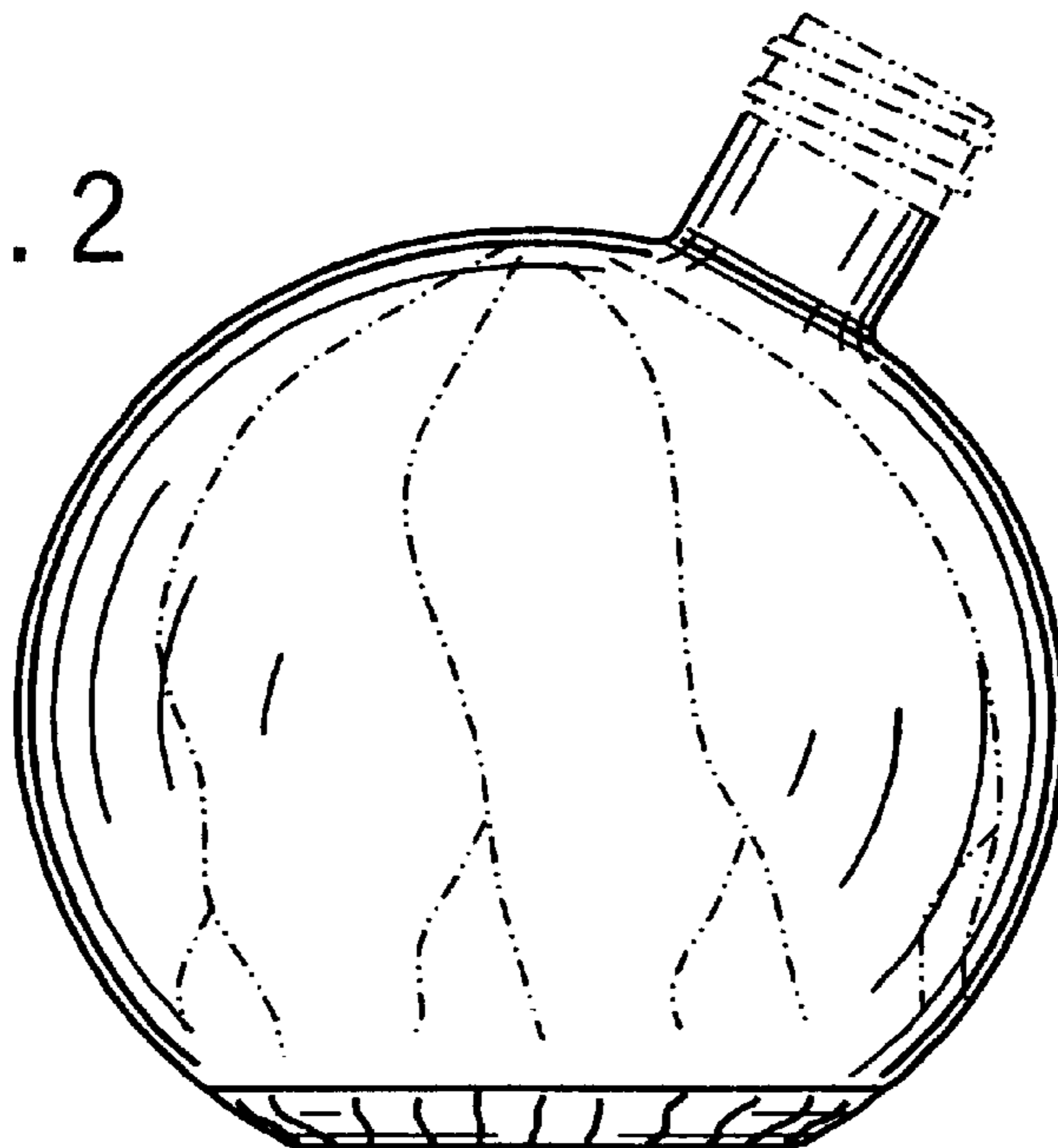

FIG. 3

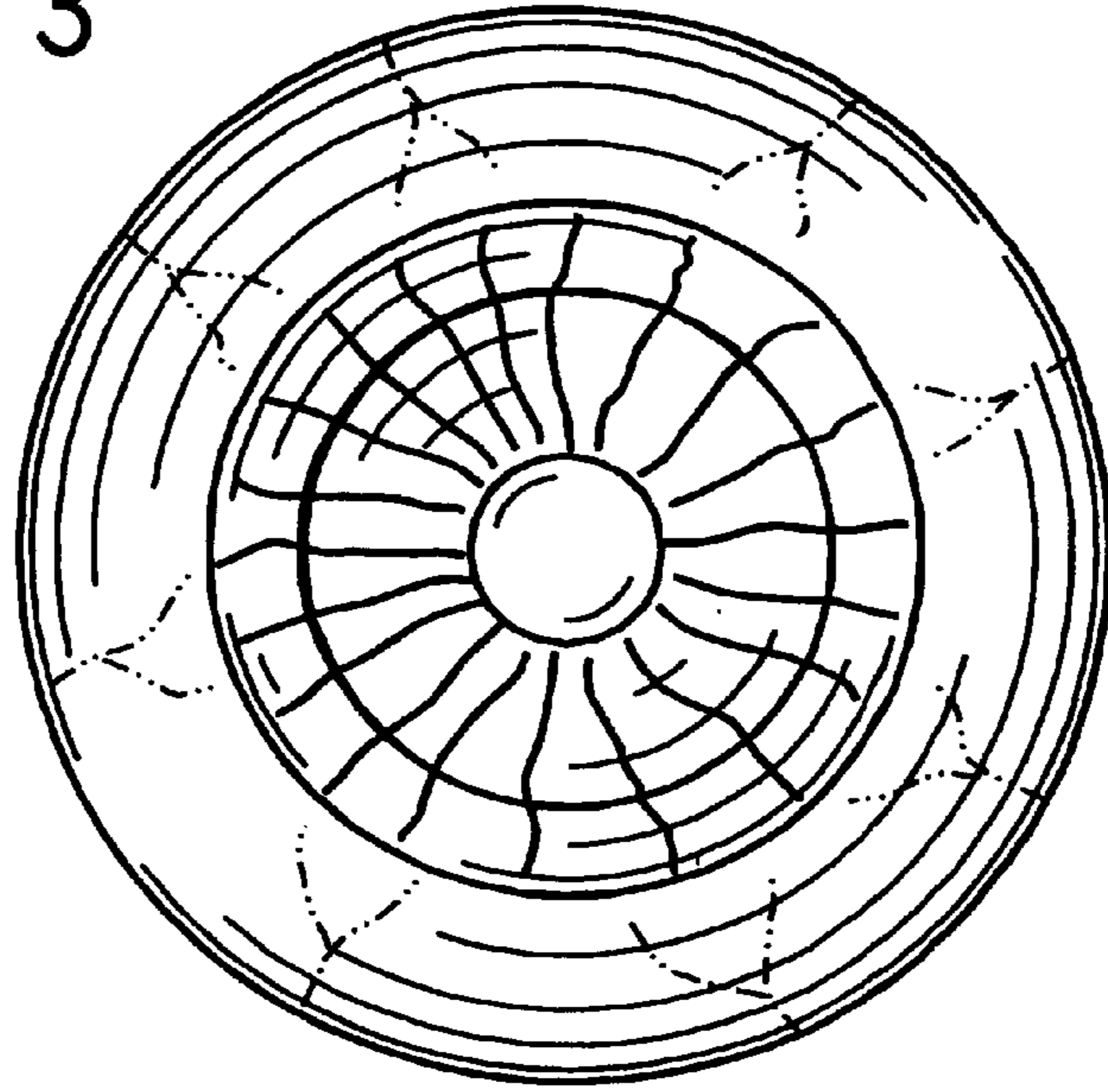

FIG. 4

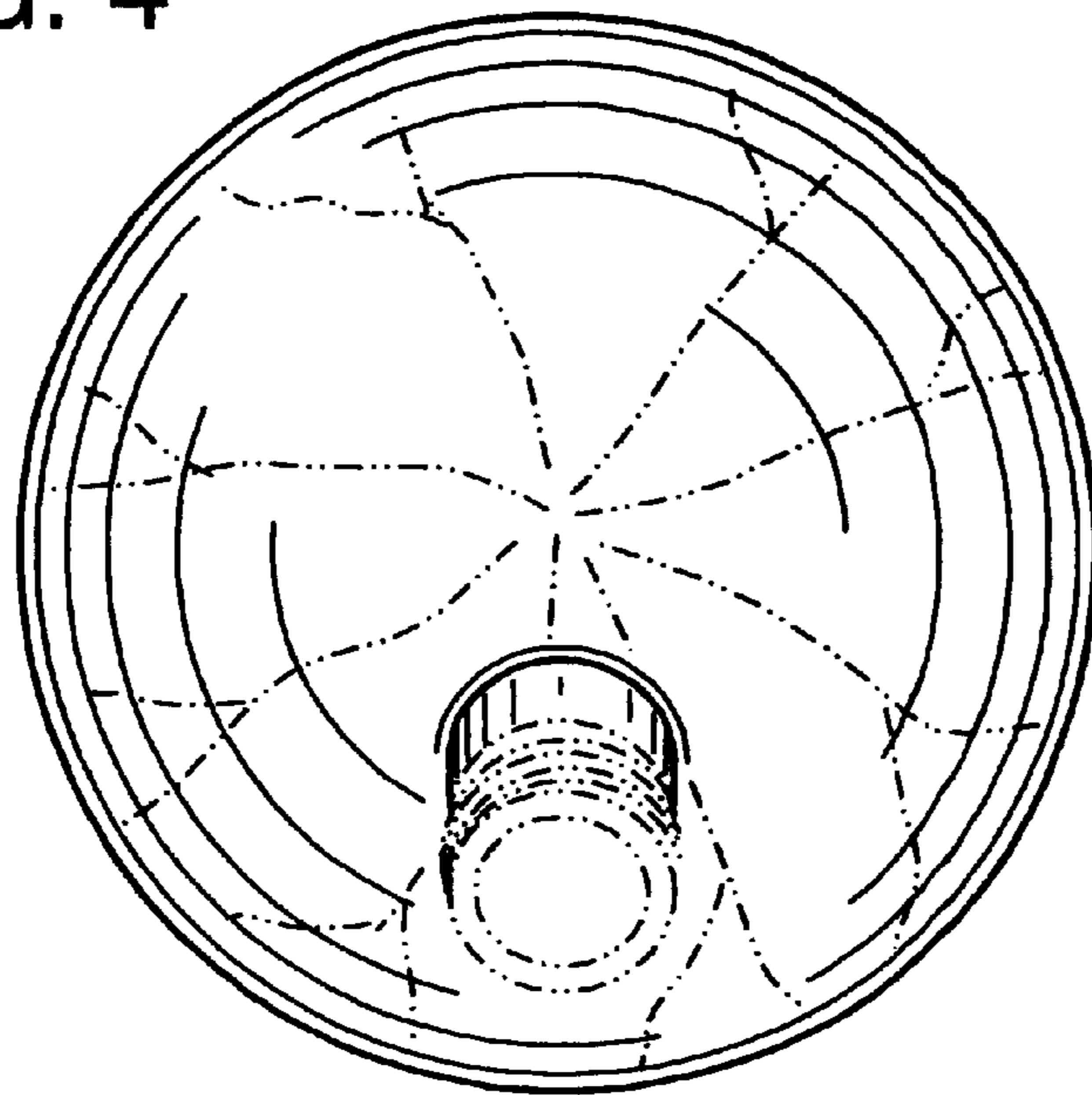

FIG. 5

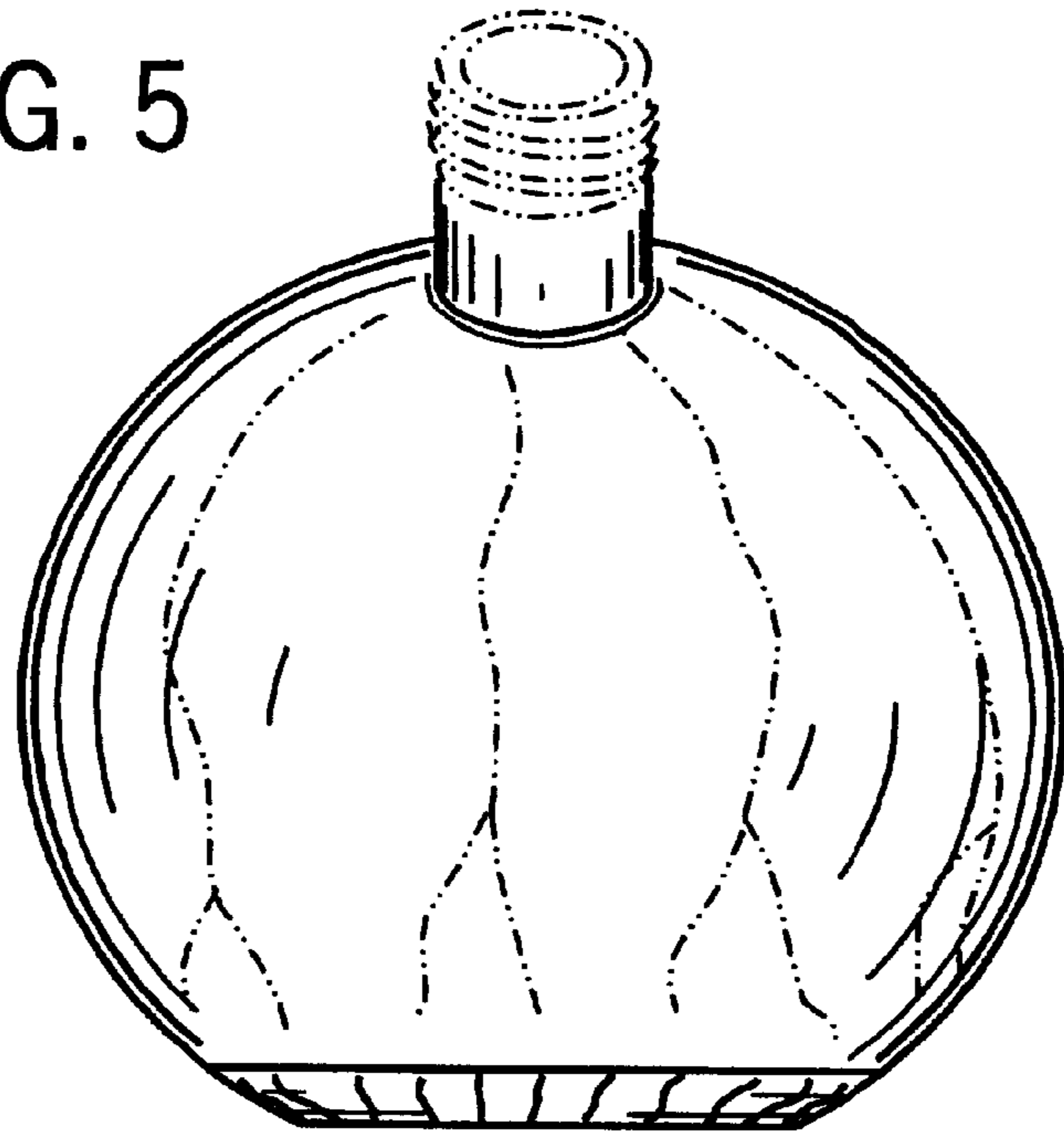

FIG. 6

