



US00D459159S

(12) **United States Design Patent**
Kao

(10) **Patent No.:** **US D459,159 S**

(45) **Date of Patent:** **** Jun. 25, 2002**

(54) **HAND JUICER**

(76) Inventor: **I-Feng Kao**, No.200, Shi-Ho Road,
West District, Tainan (TW)

(**) Term: **14 Years**

(21) Appl. No.: **29/143,061**

(22) Filed: **Jun. 6, 2001**

(51) **LOC (7) Cl.** **07-04**

(52) **U.S. Cl.** **D7/666**

(58) **Field of Search** D7/665, 666; 99/495,
99/501-508; 100/110, 125, 131-135, 213,
283

(56) **References Cited**

U.S. PATENT DOCUMENTS

2,142,975 A * 1/1939 Majewski, Jr. 100/125 X
2,588,906 A * 3/1952 Clark 100/125 X

* cited by examiner

Primary Examiner—Terry A. Wallace

(74) *Attorney, Agent, or Firm*—Alan Kamrath; Rider,
Bennett, Egan & Arundel, LLP

(57) **CLAIM**

The ornamental design for a hand juicer, as shown and described.

DESCRIPTION

FIG. 1 is a front-top-right perspective view of a hand juicer showing my design;

FIG. 2 is a front elevational view thereof;

FIG. 3 is a rear elevational view thereof;

FIG. 4 is a left elevational view thereof;

FIG. 5 is a right elevational view thereof;

FIG. 6 is a top plan view thereof; and,

FIG. 7 is a bottom plan view thereof.

1 Claim, 7 Drawing Sheets

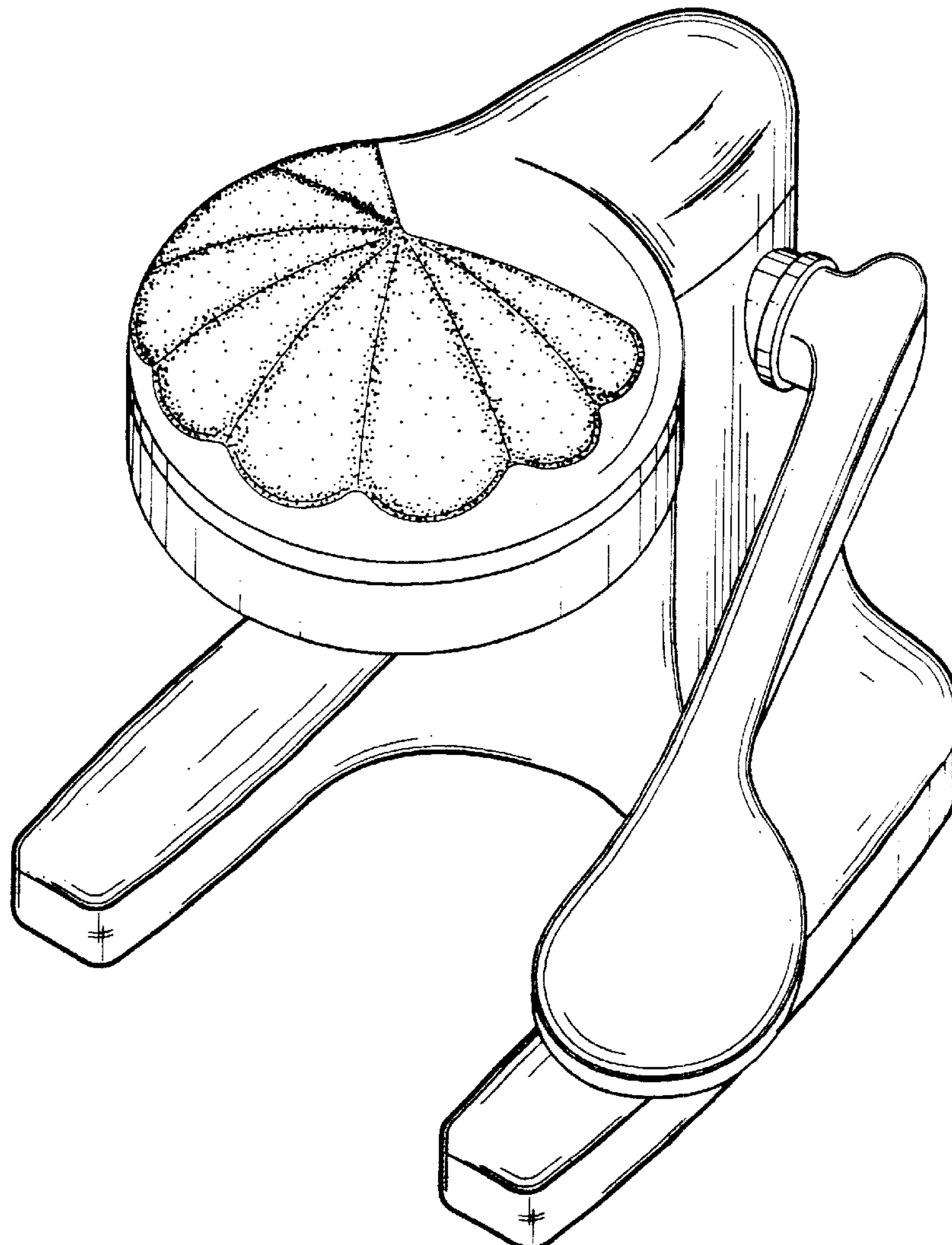

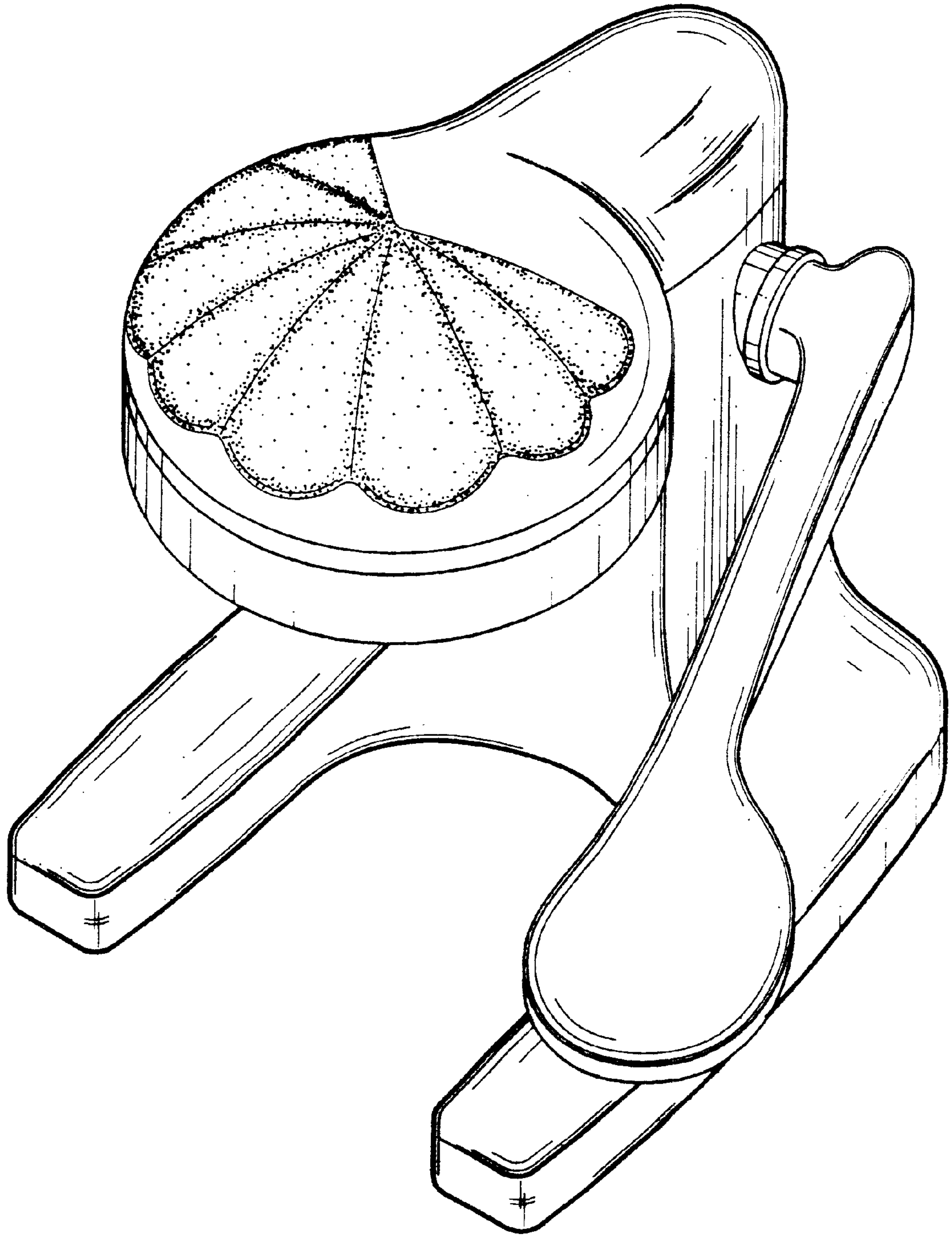

FIG. 1

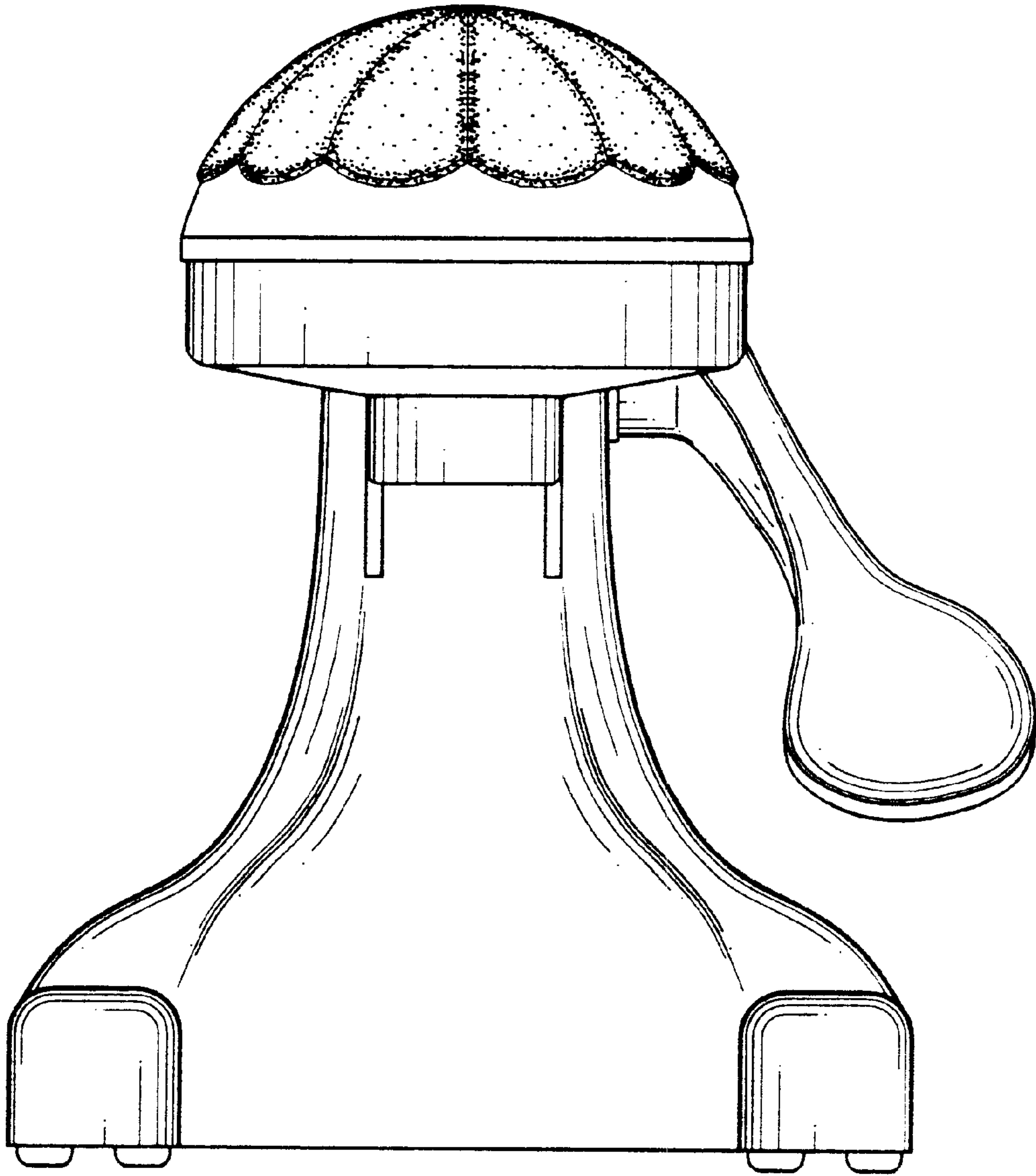

FIG. 2

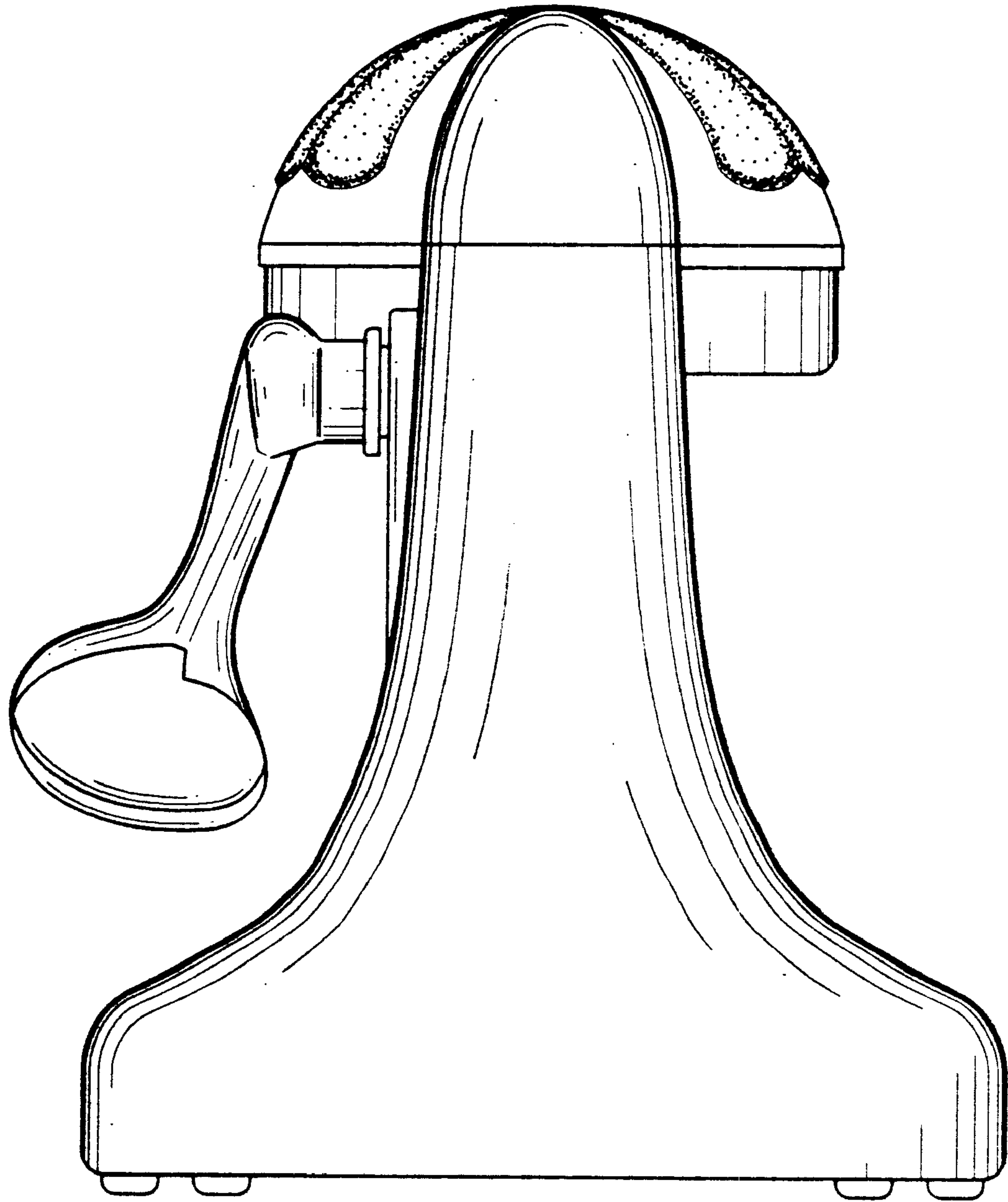

FIG. 3

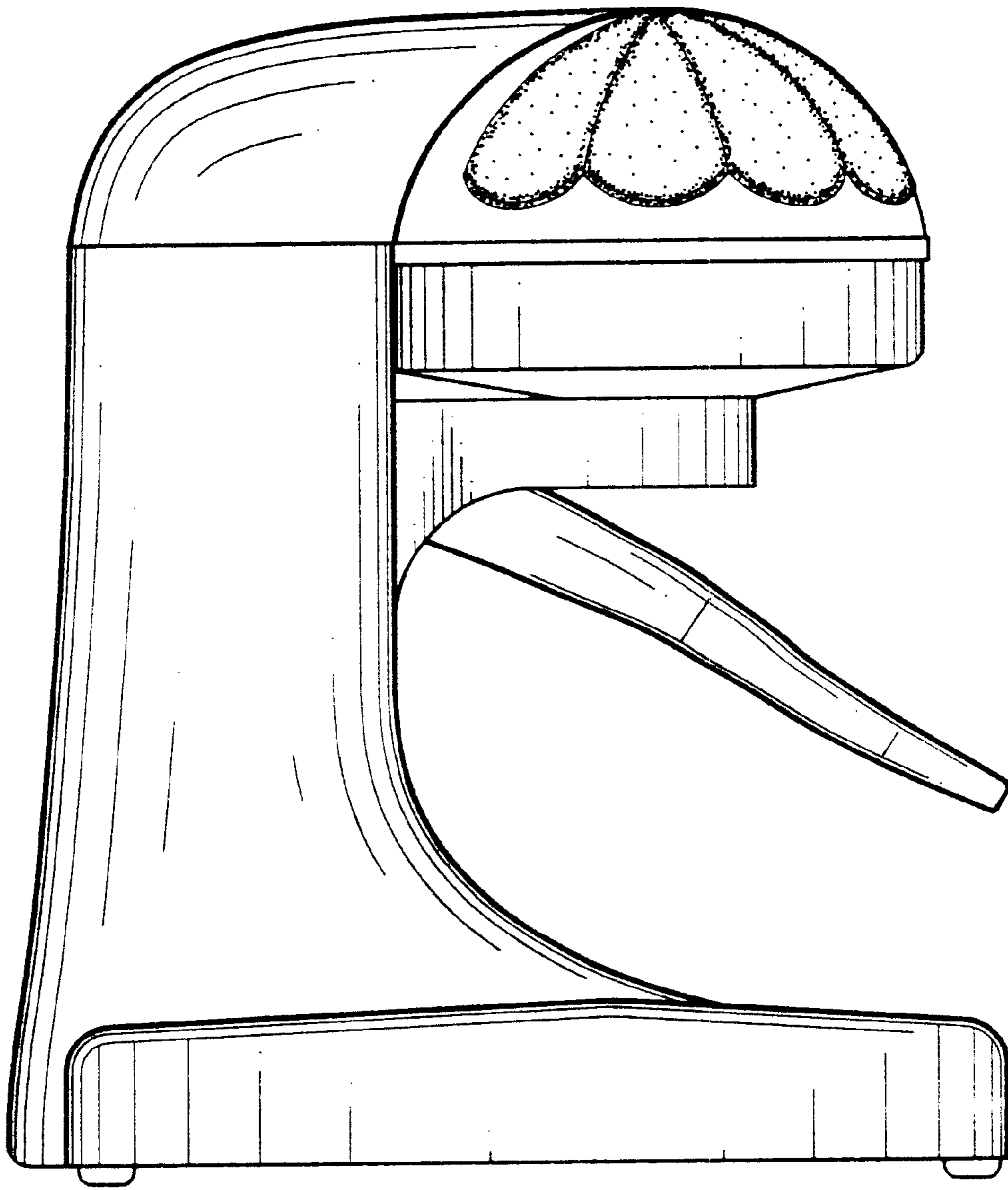

FIG. 4

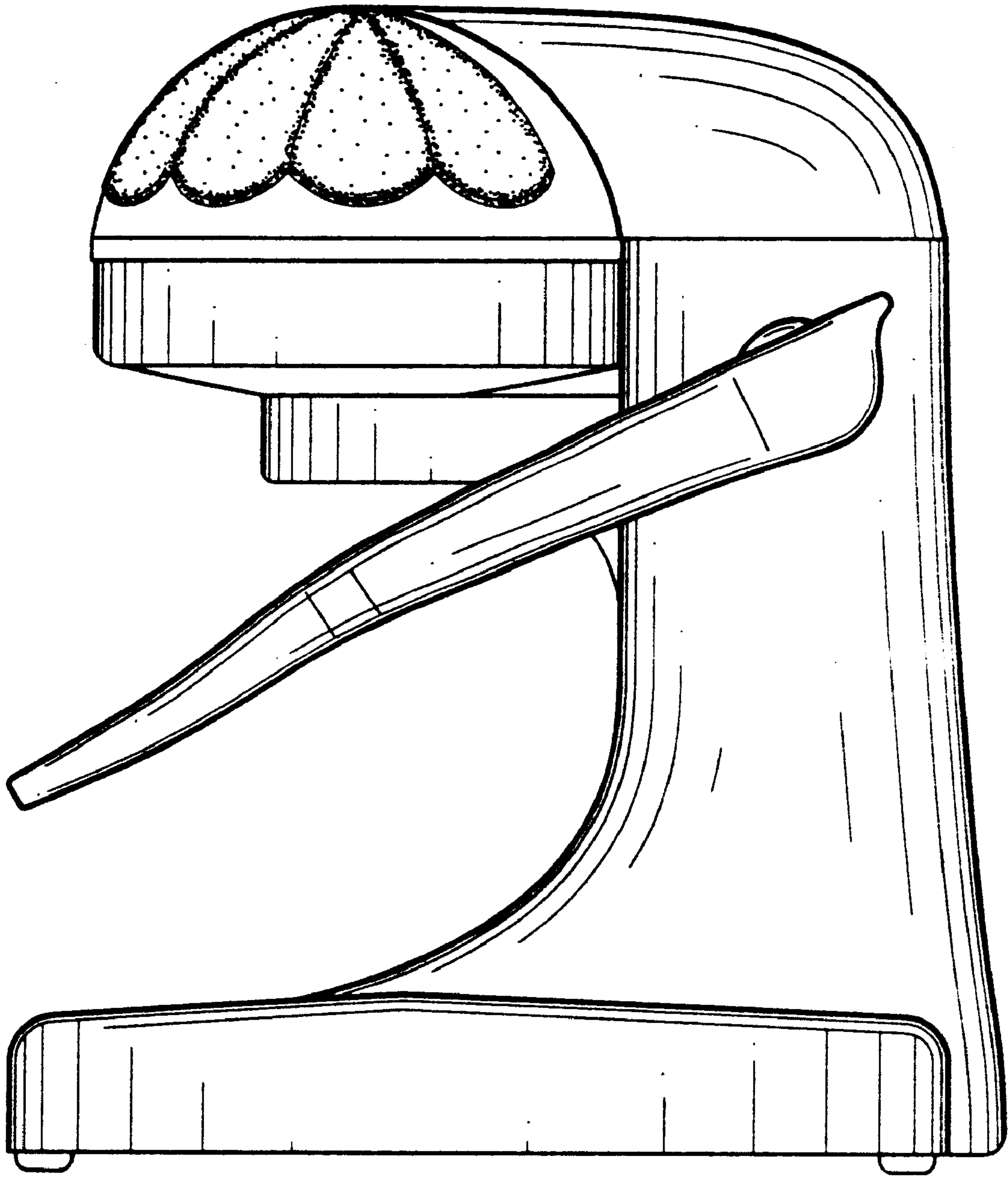

FIG. 5

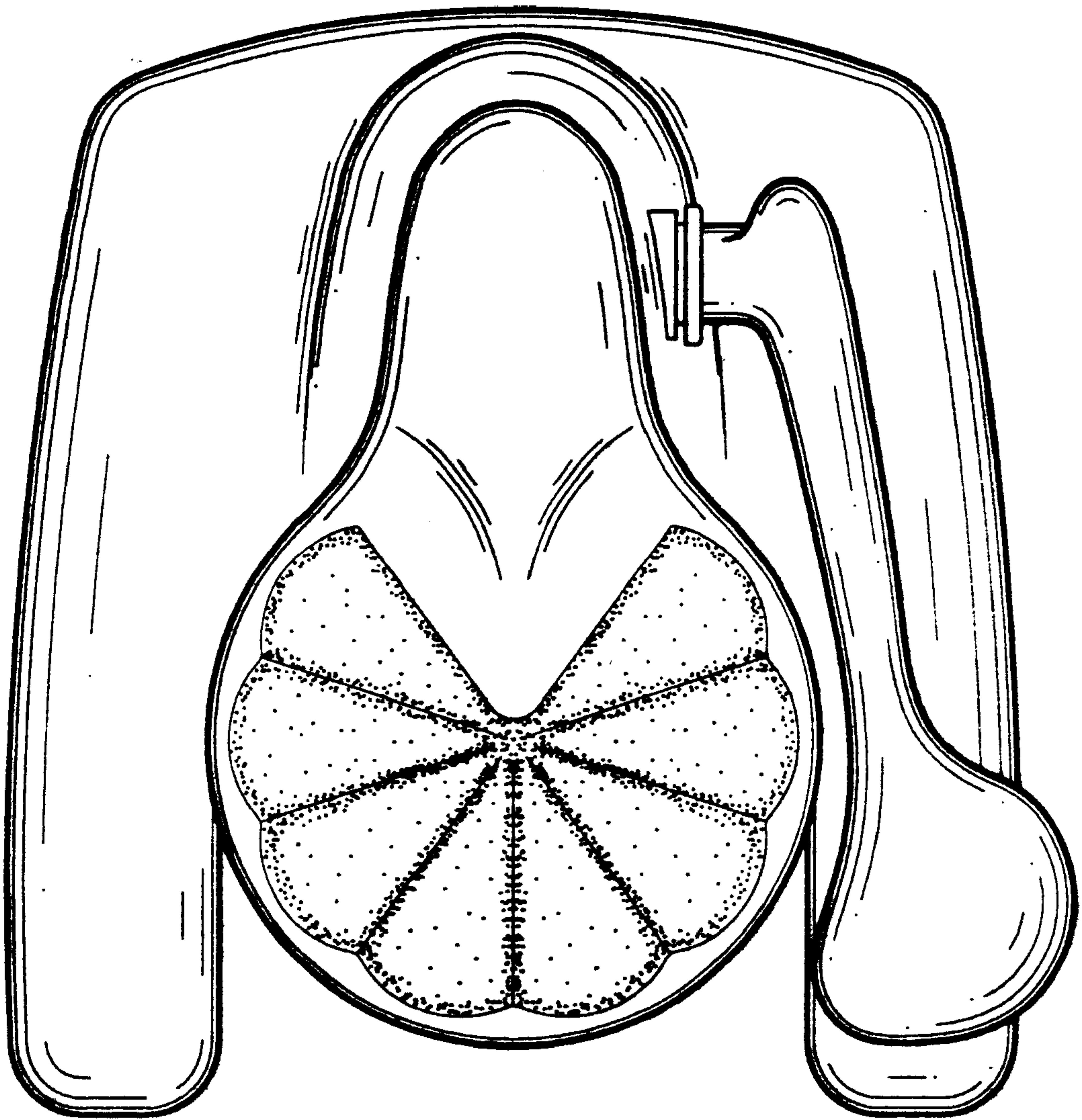

FIG. 6

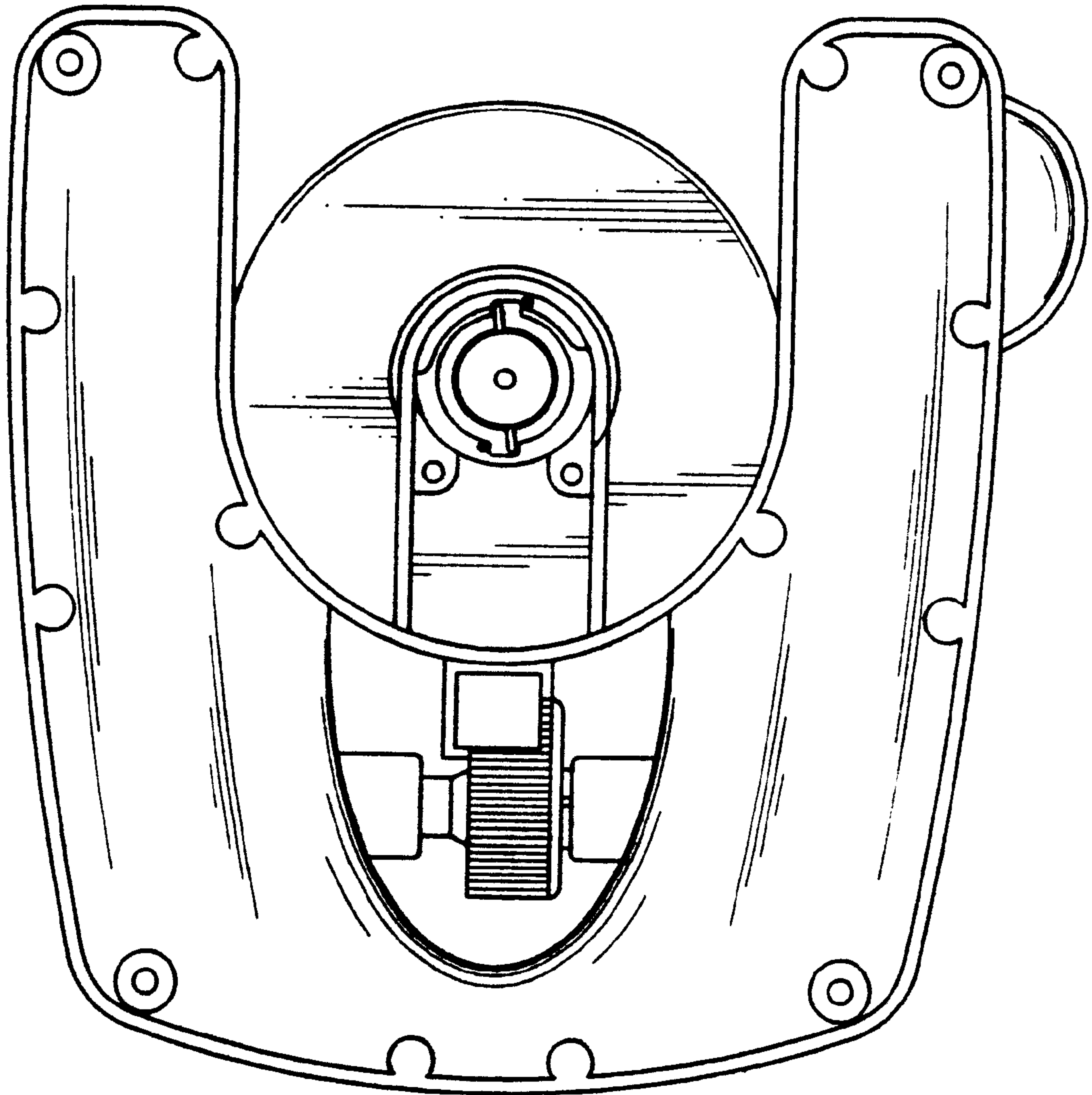

FIG. 7