



US00D459150S

(12) **United States Design Patent**  
**Lin**

(10) **Patent No.:** **US D459,150 S**

(45) **Date of Patent:** **\*\* Jun. 25, 2002**

(54) **HANDLE FOR KITCHEN UTENSIL**

(57) **CLAIM**

(76) **Inventor:** **Cheng Tung Lin**, No. 11, Shing Gong Road, Yung Kang, Tainan Hsien (TW)

The ornamental design for a handle for kitchen utensil, as shown and described.

(\*\*) **Term:** **14 Years**

**DESCRIPTION**

(21) **Appl. No.:** **29/144,669**

FIG. 1 is a perspective view of a handle for kitchen utensil showing my new design;

(22) **Filed:** **Jul. 10, 2001**

FIG. 2 is a right side elevational view thereof;

(51) **LOC (7) Cl.** ..... **07-04**

FIG. 3 is a top plan view thereof;

(52) **U.S. Cl.** ..... **D7/395**

FIG. 4 is a front elevational view thereof;

(58) **Field of Search** ..... D7/393-395, 401.2, D7/642-664, 681-697; D8/107; 16/110.1, 430, 431, 436; 30/324-328; 294/7, 8

FIG. 5 is a bottom plan view thereof;

FIG. 6 is a left side elevational view thereof; and,

FIG. 7 is a rear elevational view thereof; and,

(56) **References Cited**

**U.S. PATENT DOCUMENTS**

D124,852 S	*	1/1941	Beck	.....	D7/395
5,964,009 A	*	10/1999	Hoepfl et al.	.....	16/430
D427,044 S	*	6/2000	White et al.	.....	D7/395

FIG. 8 is a front elevational view thereof, with the fork being shown in broken lines for illustrative purposes only and forming no part of the claimed design;

FIG. 9 is a front elevational view thereof, the slotted lifter shown in broken lines for illustrative purposes only and forming no part of the claimed design; and,

FIG. 10 is a front elevational view thereof, the knife shown in broken lines for illustrative purposes only and forming no part of the claimed design.

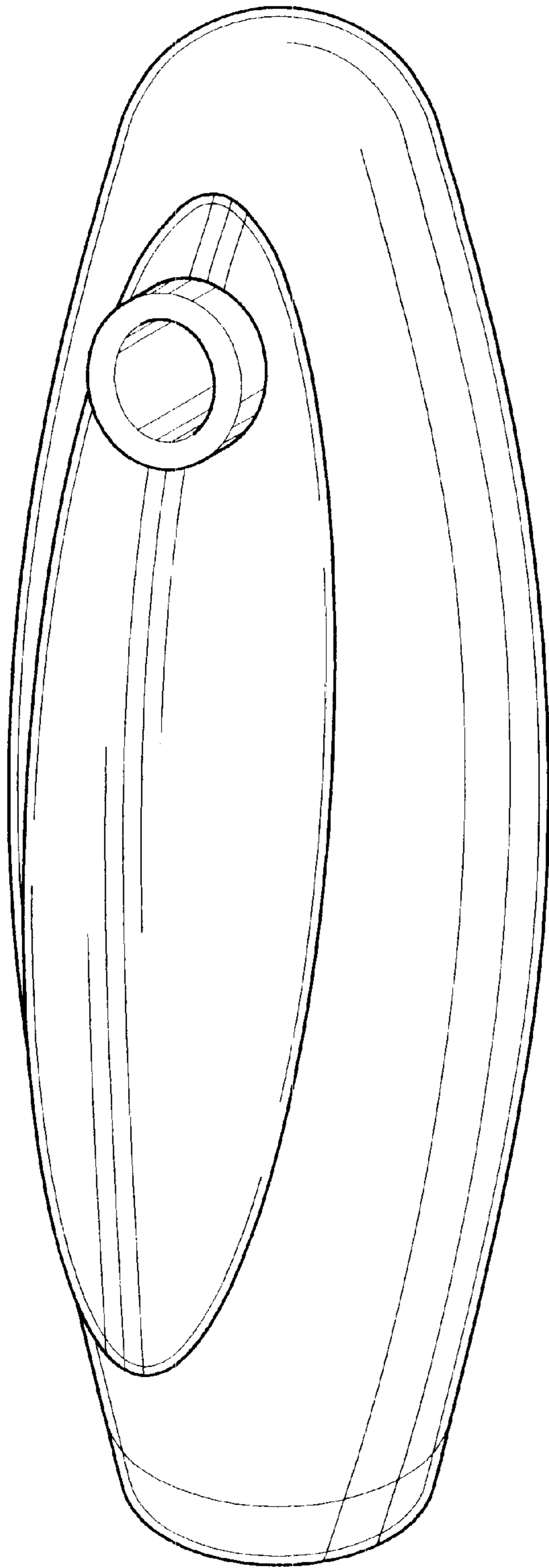
\* cited by examiner

*Primary Examiner*—Terry A. Wallace

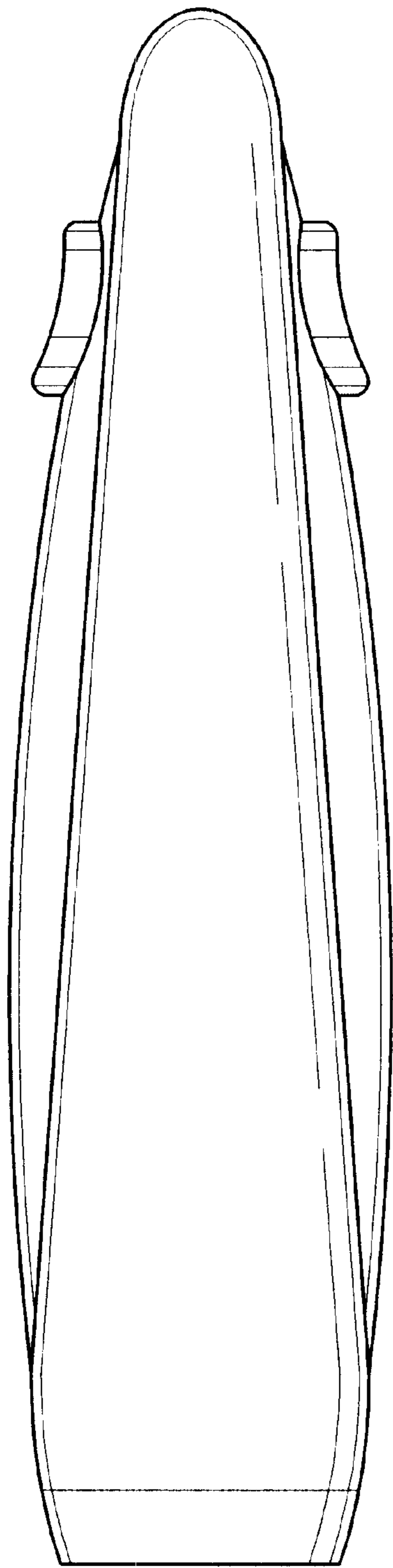
(74) *Attorney, Agent, or Firm*—Bacon & Thomas, PLLC

**1 Claim, 5 Drawing Sheets**

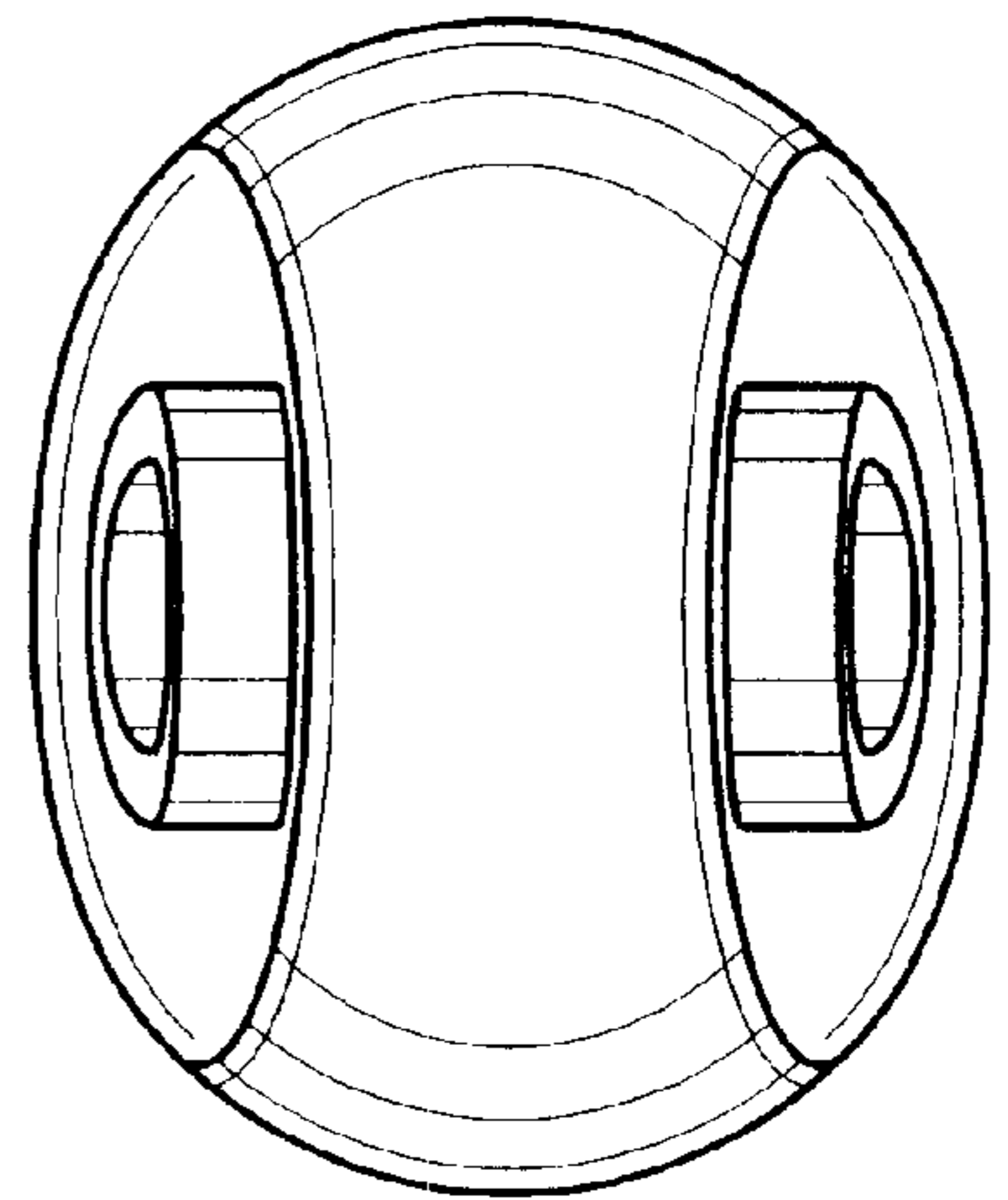




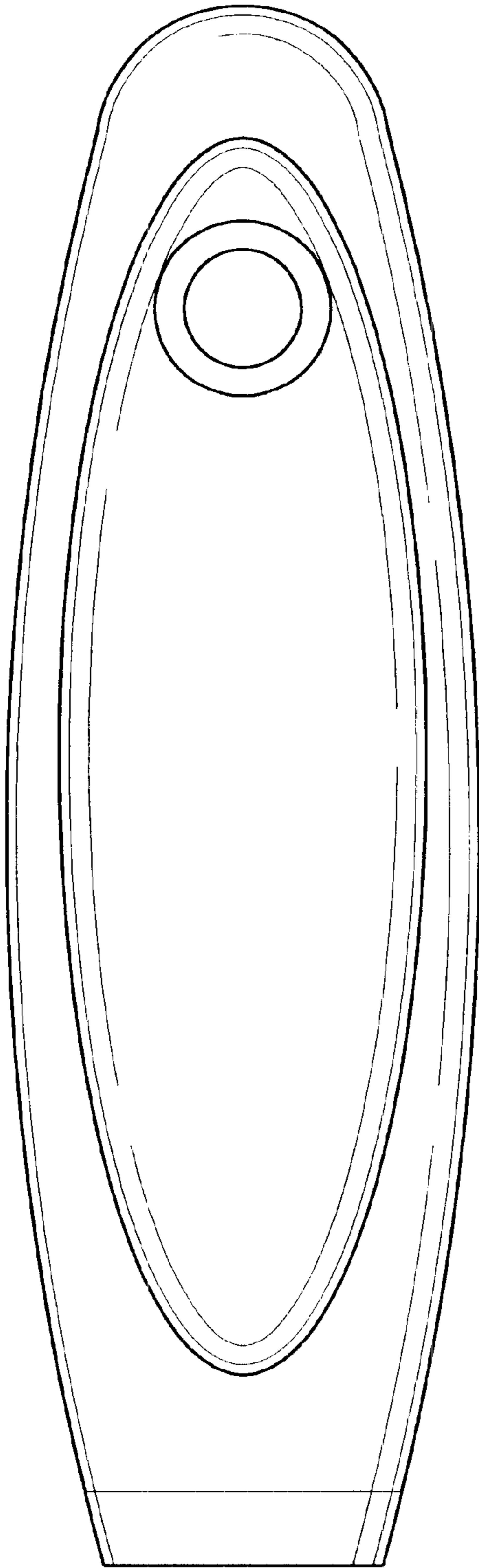
*FIG. 1*



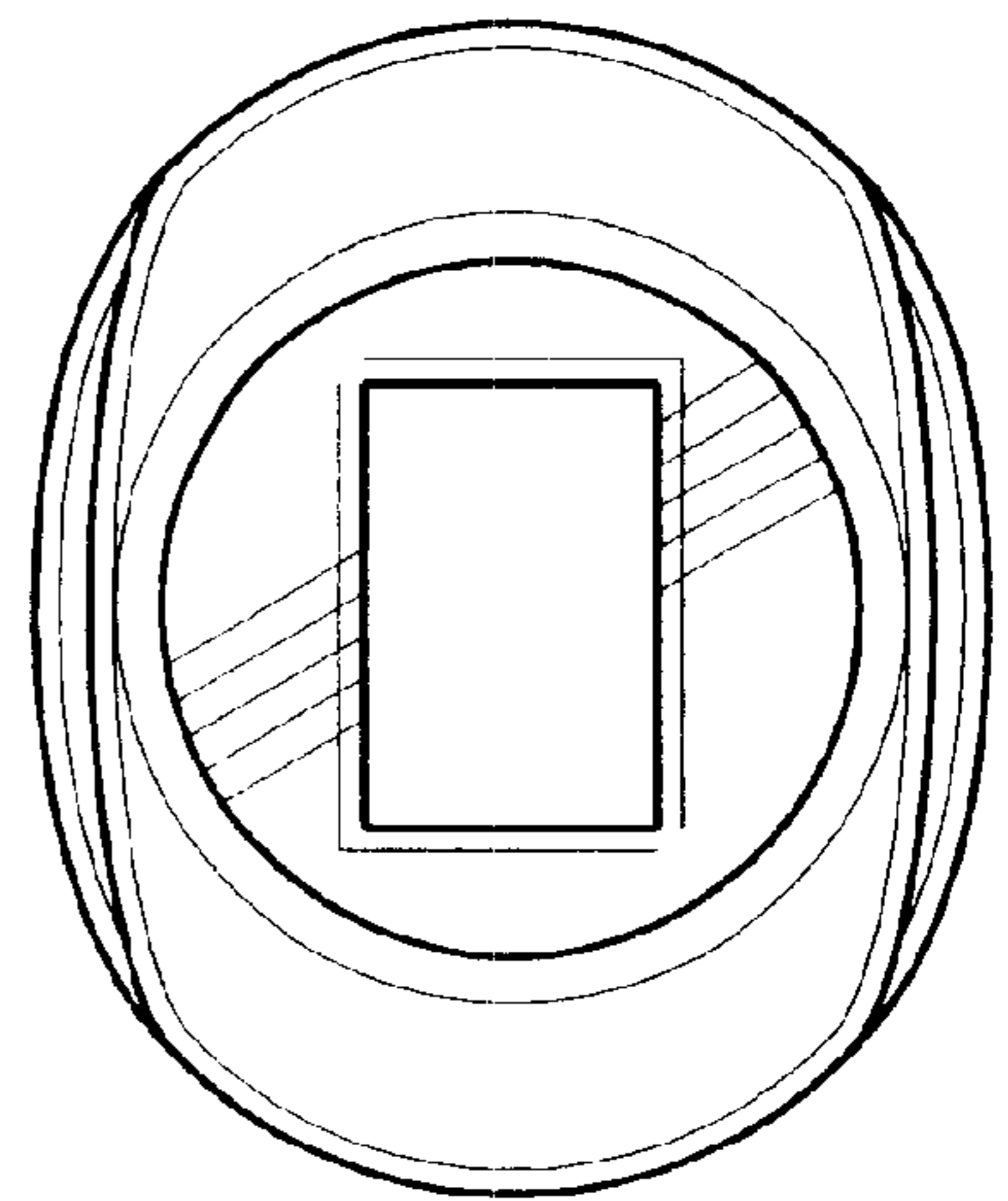
*FIG. 2*



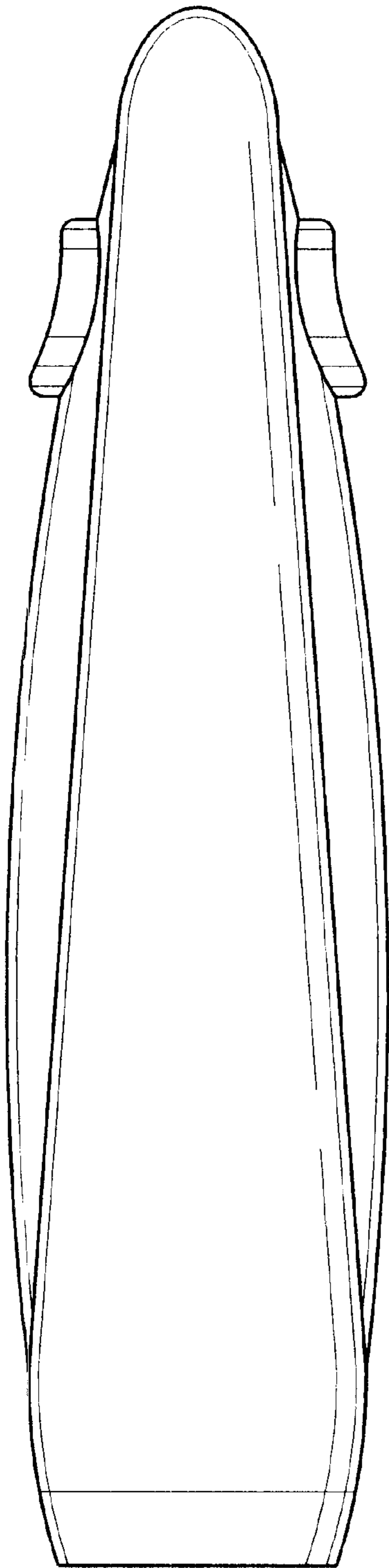
*FIG. 3*



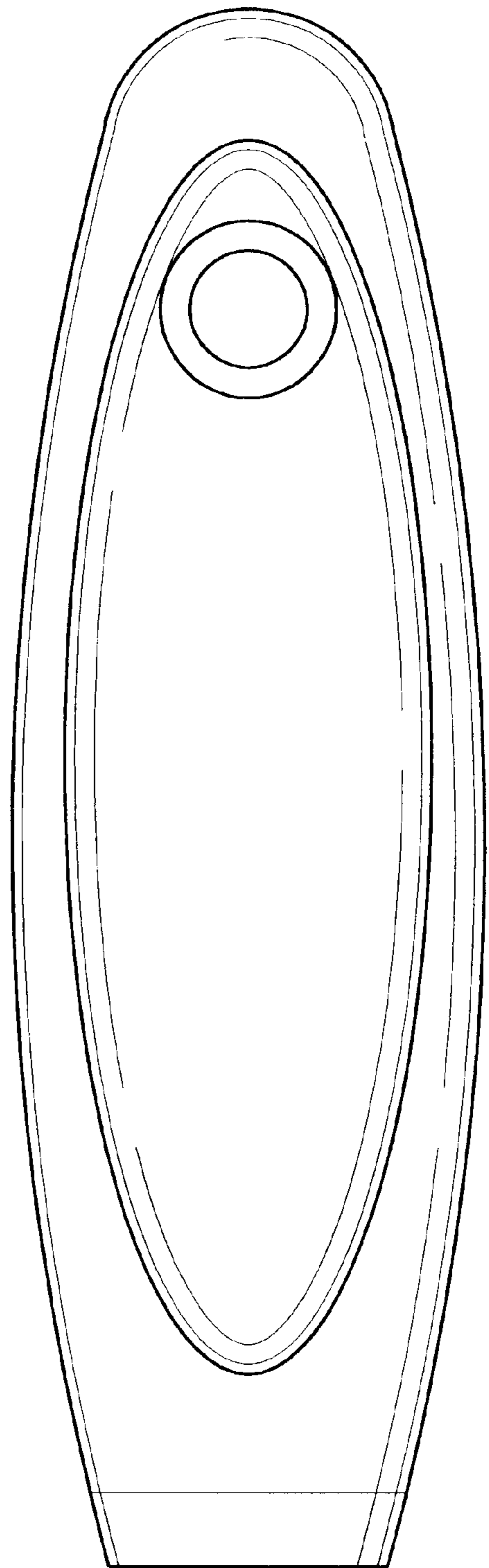
*FIG. 4*



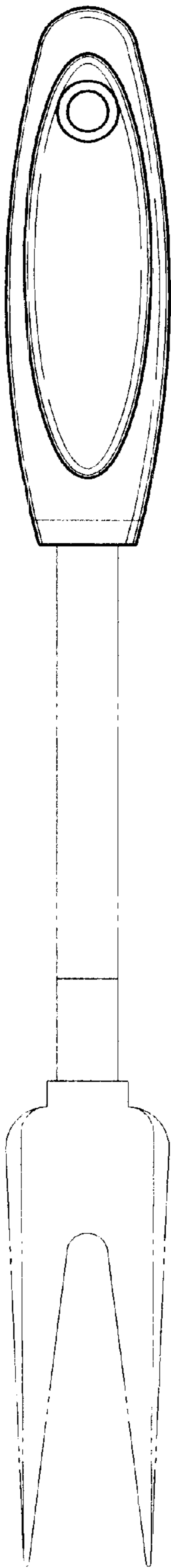
*FIG. 5*



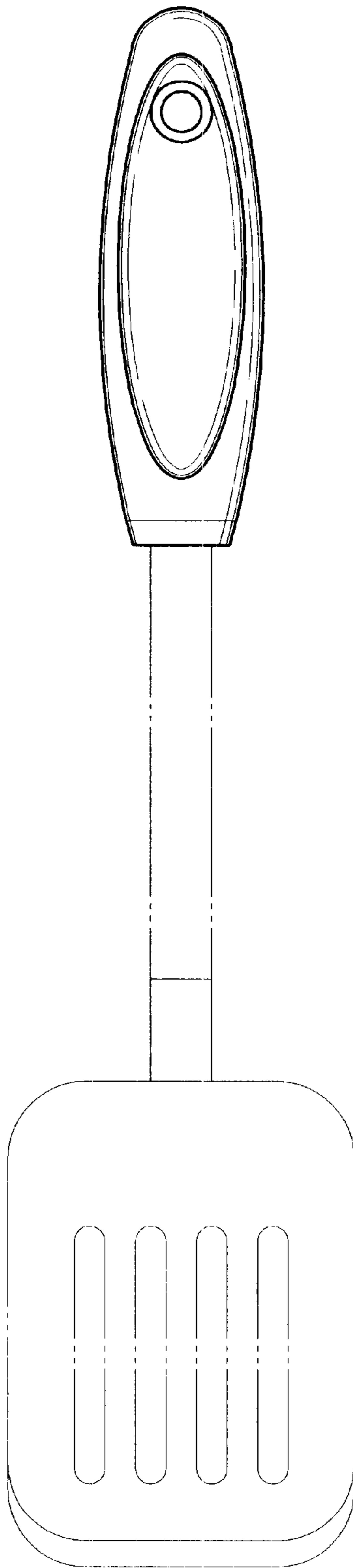
*FIG. 6*



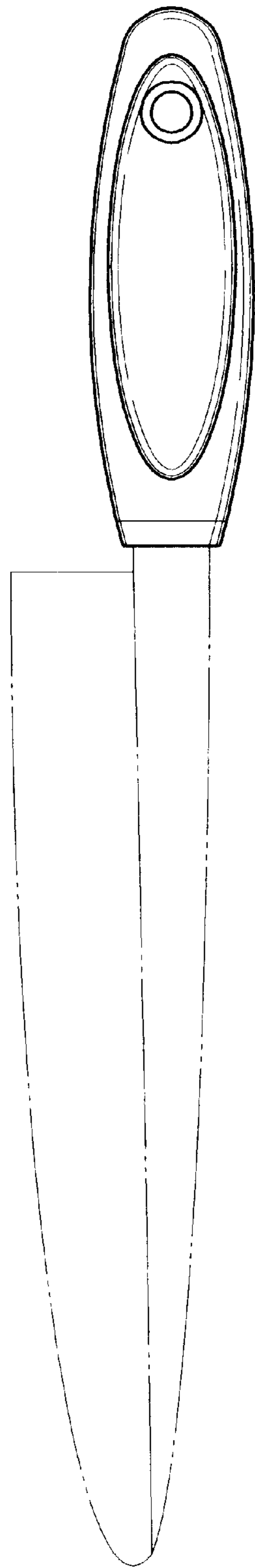
*FIG. 7*



*FIG. 8*



*FIG. 9*



*FIG. 10*