



US00D459105S

(12) **United States Design Patent**  
**Stanton**

(10) **Patent No.:** **US D459,105 S**

(45) **Date of Patent:** **\*\* Jun. 25, 2002**

(54) **BEDSTEAD**

(75) **Inventor:** **Shawn Christopher Stanton**, High Point, NC (US)

(73) **Assignee:** **Thomasville Furniture Industries, Inc.**, Thomasville, NC (US)

(\*\*) **Term:** **14 Years**

(21) **Appl. No.:** **29/147,690**

(22) **Filed:** **Aug. 31, 2001**

(51) **LOC (7) Cl.** ..... **06-01**

(52) **U.S. Cl.** ..... **D6/393**

(58) **Field of Search** ..... D6/382, 384, 392-395, D6/505-508; 5/53.1, 279.1, 280, 281, 907

(56) **References Cited**

**U.S. PATENT DOCUMENTS**

D342,394 S	*	12/1993	Black	.....	D6/393
D373,486 S	*	9/1996	Keller et al.	.....	D6/393
D390,375 S		2/1998	Walters, III et al.	.....	D6/393
D392,811 S	*	3/1998	Bergelin	.....	D6/393
D429,084 S		8/2000	Wistehuff, Sr.	.....	D6/393

**OTHER PUBLICATIONS**

Sleigh Bed, Elysee Collection brochure, Thomasville Furniture Industries, Inc., p. 3, 1999.

Jacob Sleigh Bed, Hemingway Paris Collection brochure, Thomasville Furniture Industries, Inc., p. 22-23, 2000.

\* cited by examiner

*Primary Examiner*—Janice E. Seeger

(74) *Attorney, Agent, or Firm*—Womble Carlyle Sandridge & Rice, PLLC

(57) **CLAIM**

The ornamental design for a bedstead, as shown and described.

**DESCRIPTION**

FIG. 1 is a left front perspective view of a bedstead showing my new design;

FIG. 2 is a side elevational view, the opposite side being a mirror image thereof;

FIG. 3 is a front elevational view of the headboard section thereof;

FIG. 4 is a front elevational view of the footboard section thereof;

FIG. 5 is a rear perspective view of the footboard section thereof; and,

FIG. 6 is a front elevational view thereof.

The broken lines are for environmental purposes only and form no part of the claimed design.

The bottom view of the bedstead and the rear view of the headboard section are not shown and form no part of the claimed design.

**1 Claim, 6 Drawing Sheets**

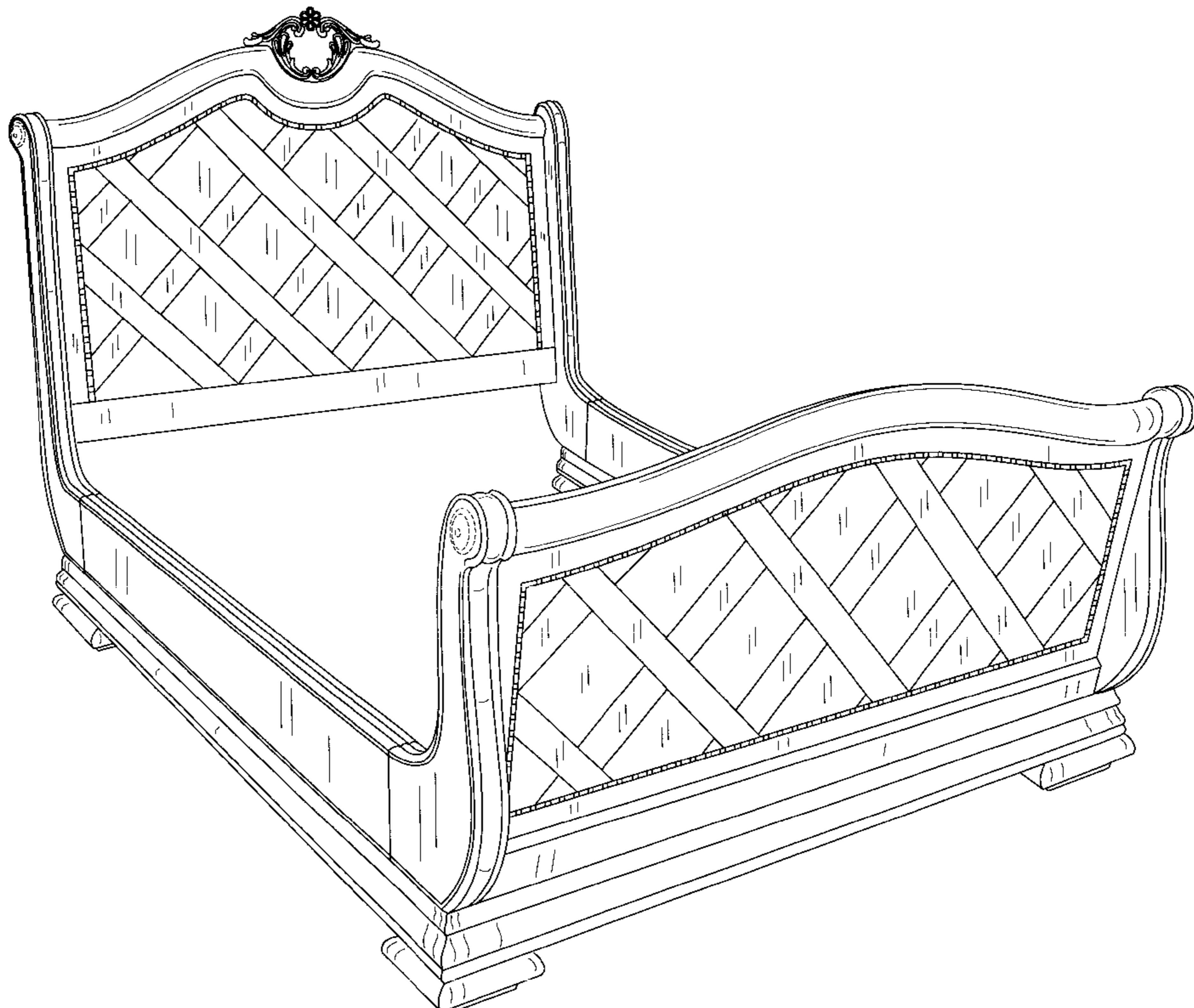

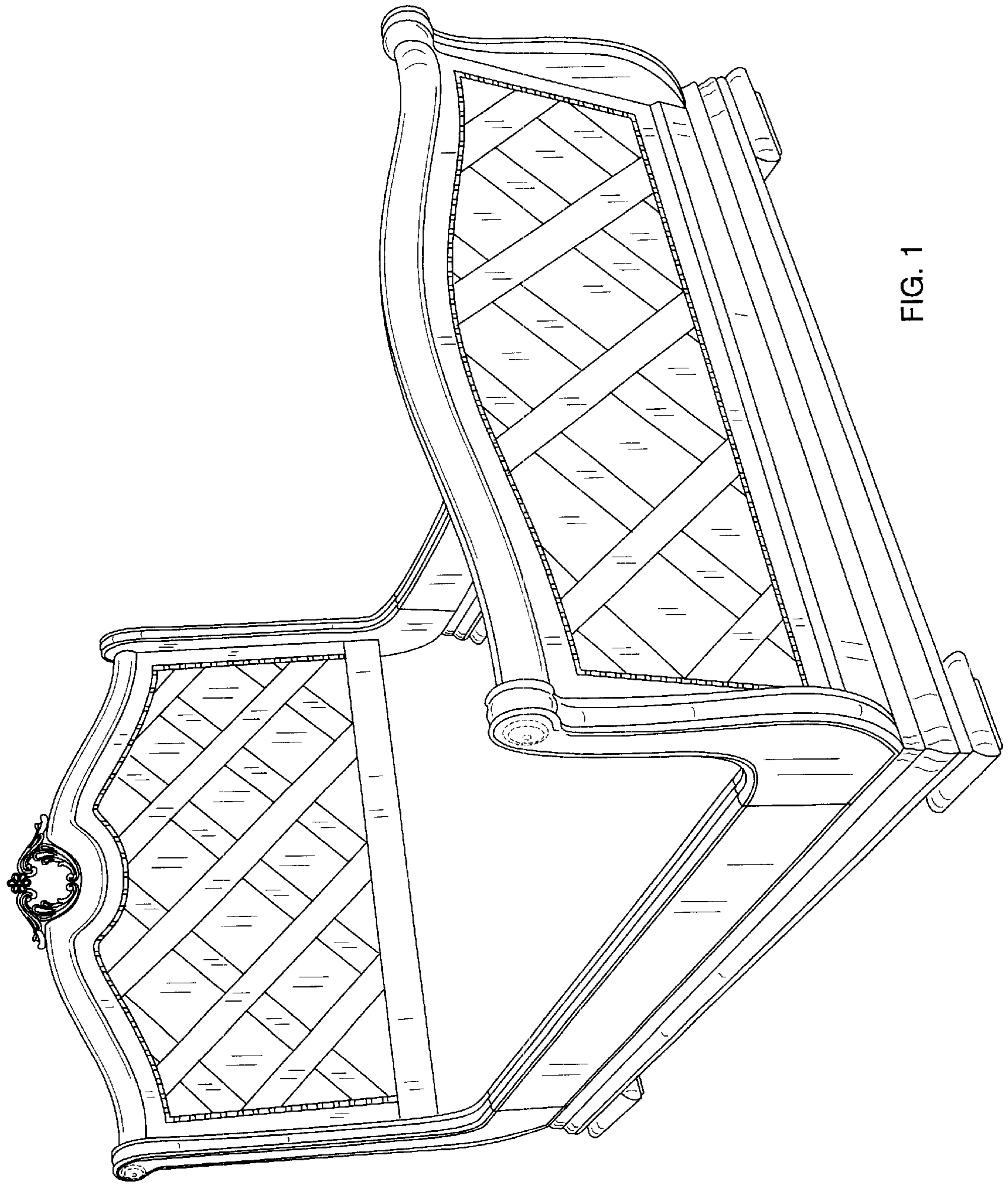

FIG. 1

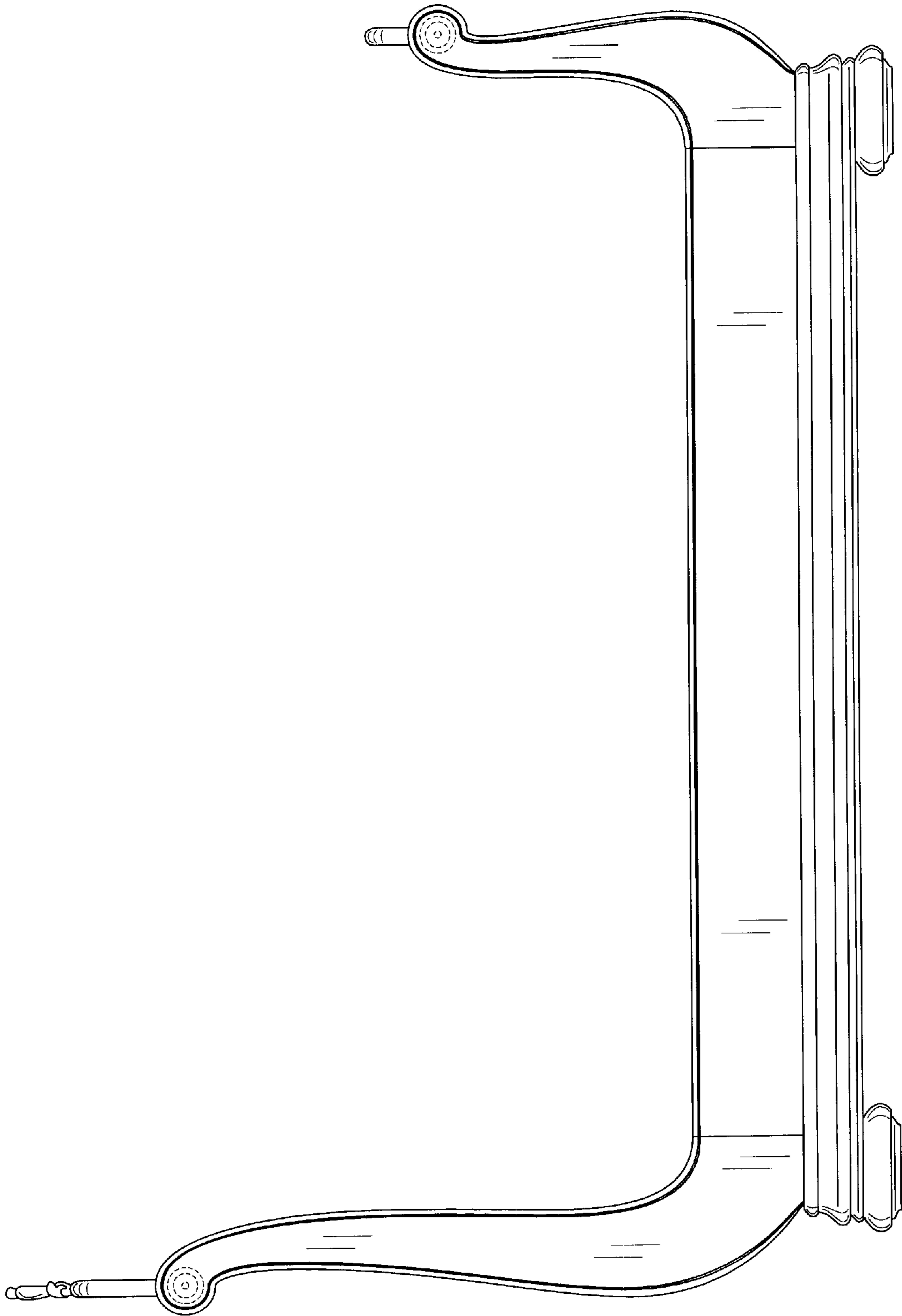

FIG. 2

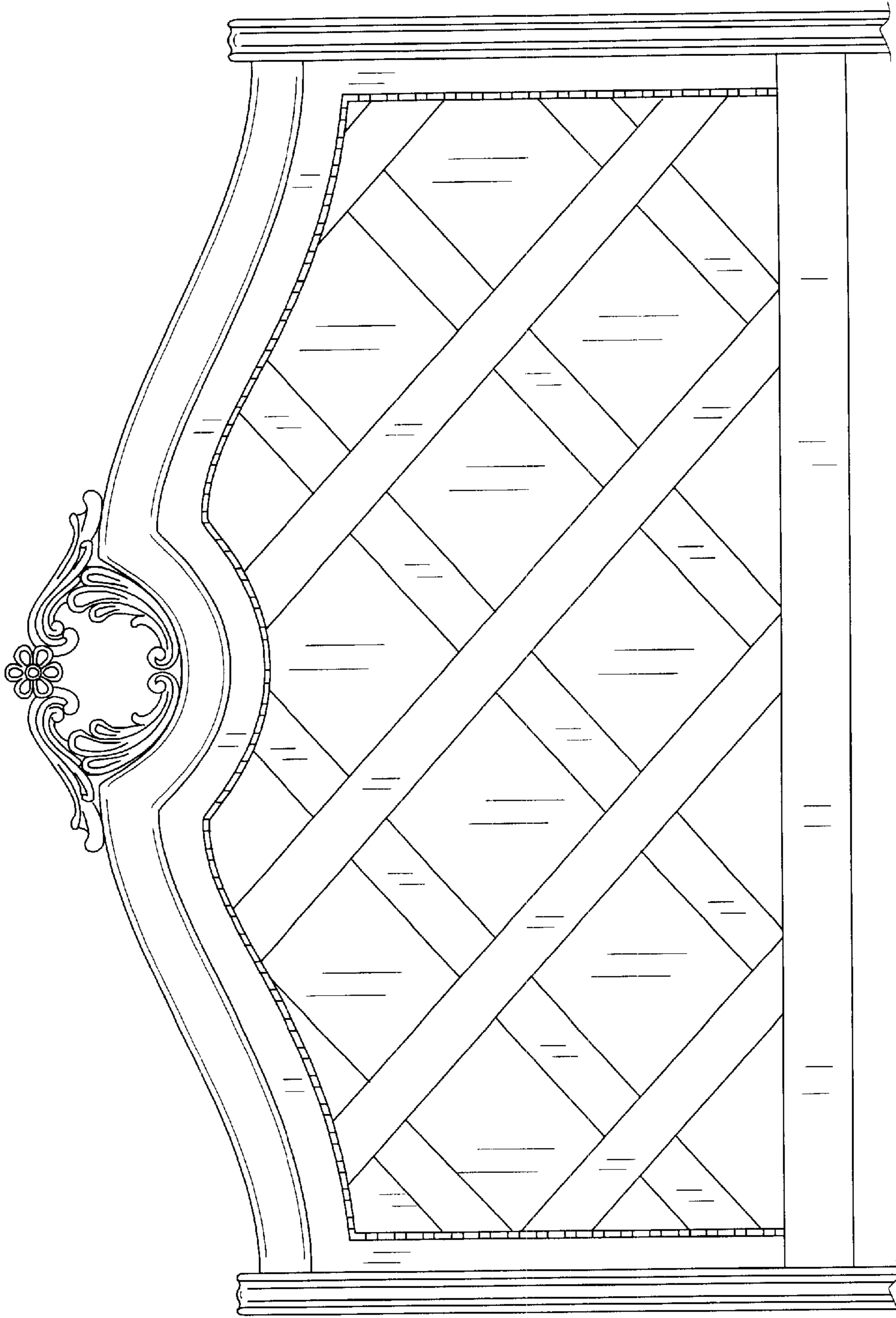

FIG. 3

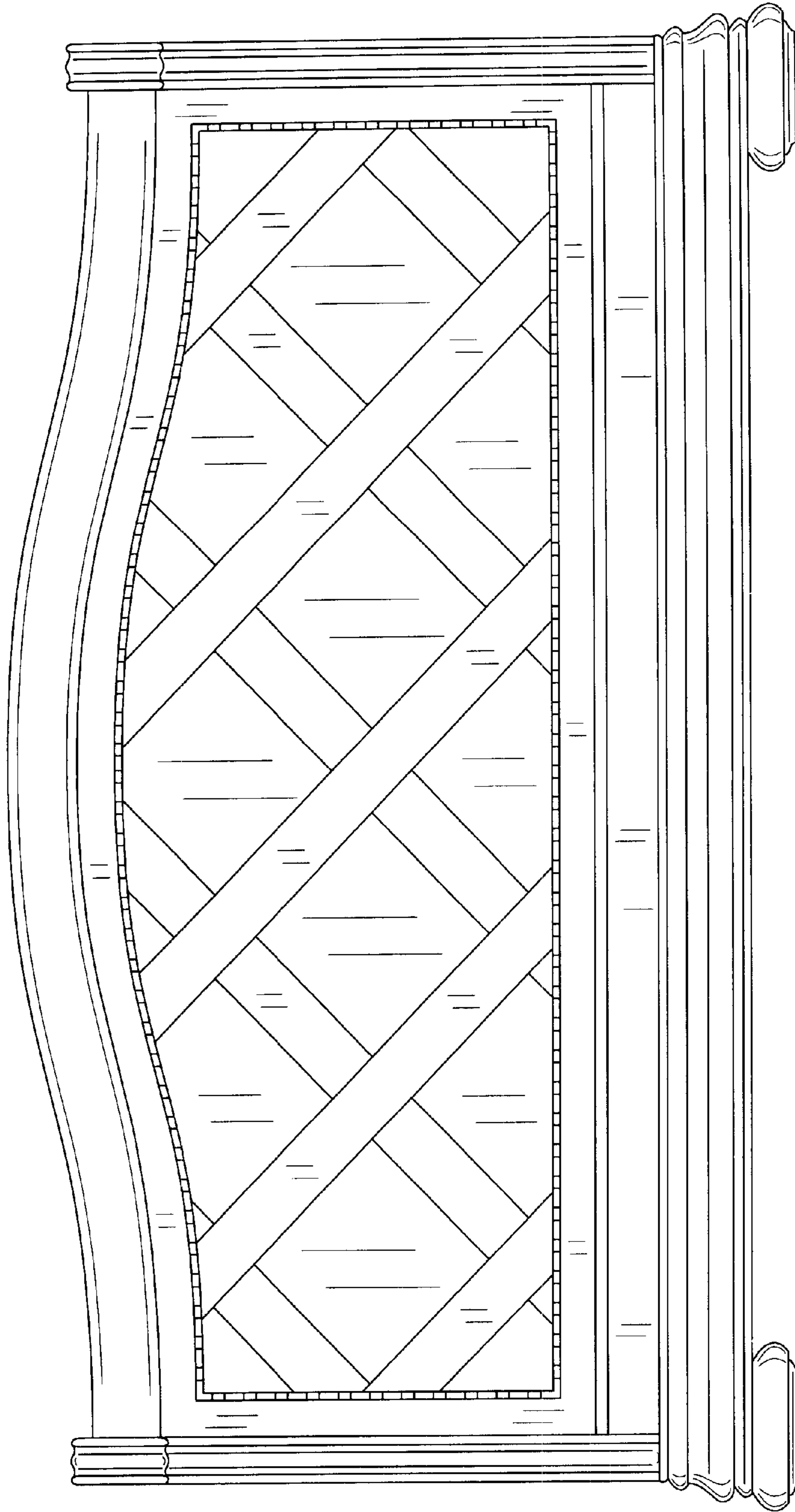

FIG. 4

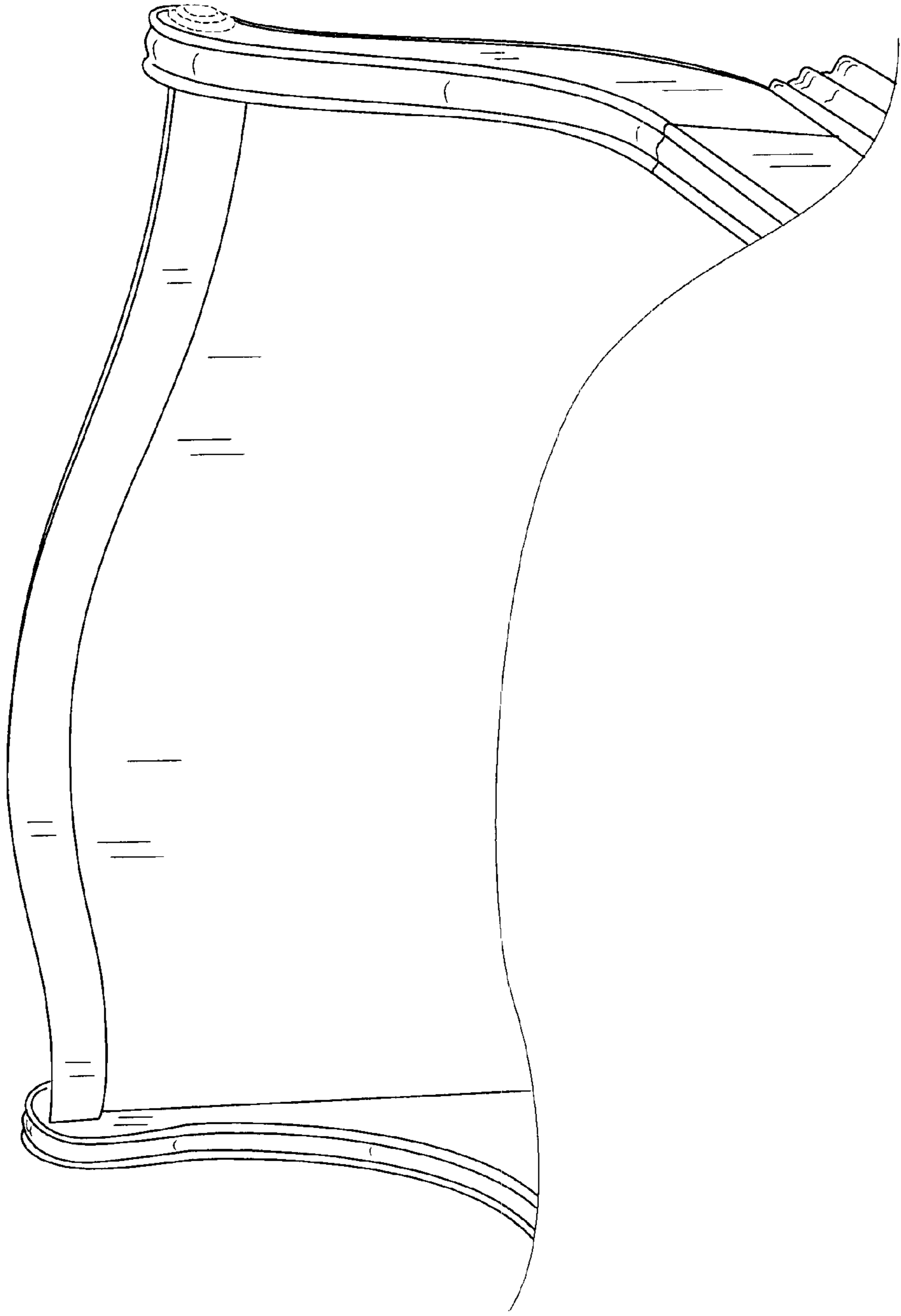

FIG. 5

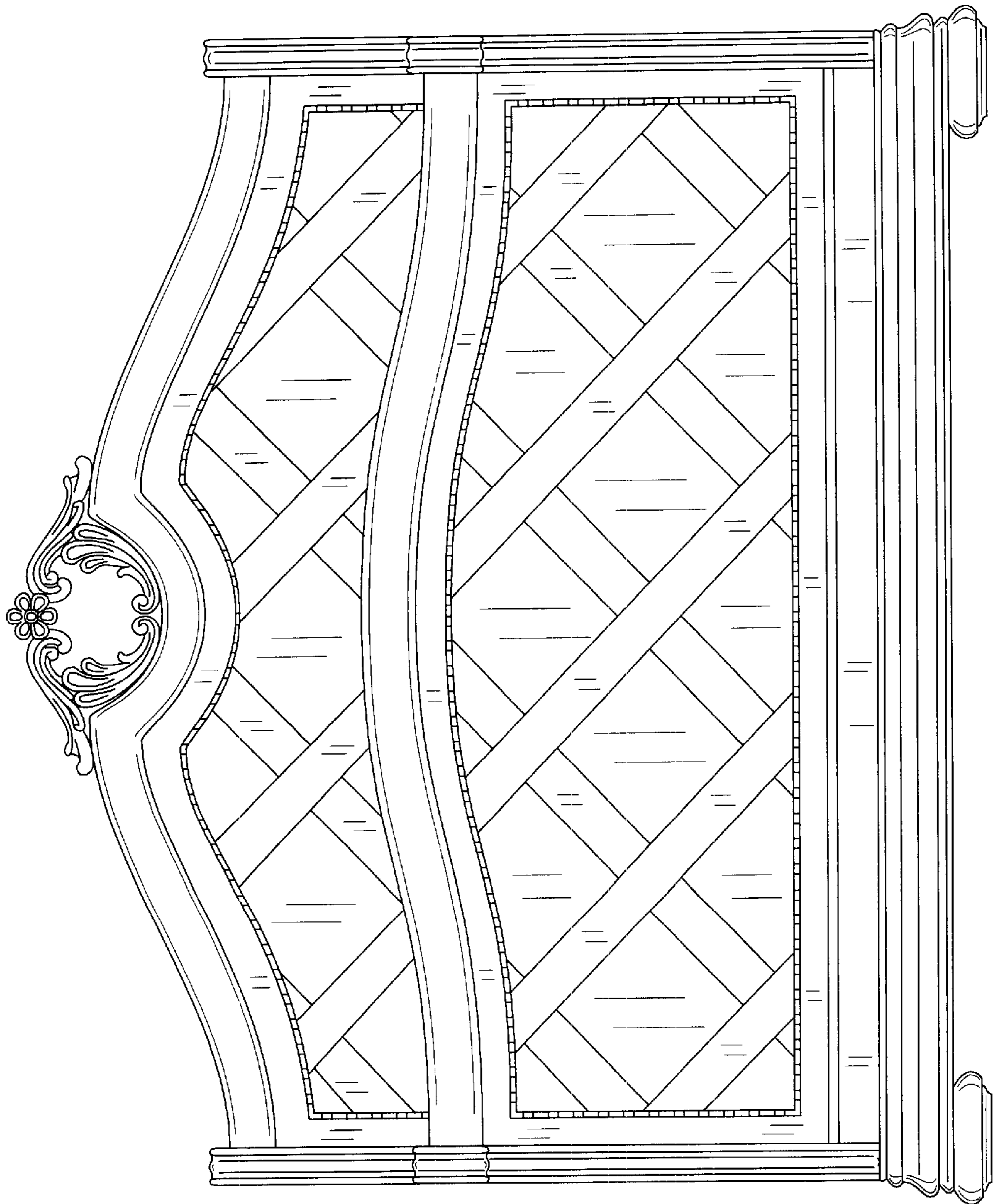

FIG. 6