



US00D459034S

(12) **United States Design Patent**  
**Dix et al.**

(10) **Patent No.:** **US D459,034 S**

(45) **Date of Patent:** **\*\* Jun. 18, 2002**

(54) **EAR MUFF WITH SIDE MOUNT**  
(75) Inventors: **Dan Dix**, Irvine; **Terry L. Grimsley**,  
Torrance; **Mark Magidson**, Culver  
City, all of CA (US)

(73) Assignee: **Moldex-Metric, Inc.**, Culver City, CA  
(US)

(\*\*) Term: **14 Years**

(21) Appl. No.: **29/141,799**

(22) Filed: **May 10, 2001**

(51) **LOC (7) Cl.** ..... **29-02**

(52) **U.S. Cl.** ..... **D29/112**

(58) **Field of Search** ..... D29/102-112,  
D29/122; 2/422-425, 9, 410-412, 414,  
416, 417, 171.3, 209, 455, 174; D14/205,  
206, 223; 181/129-130; 128/864, 866,  
867

(56) **References Cited**

**U.S. PATENT DOCUMENTS**

D375,584 S \* 11/1996 Westerdal ..... D29/112

D385,665 S \* 10/1997 Westerdal ..... D29/112  
D409,615 S \* 5/1999 Sloan ..... D14/205  
D410,238 S \* 5/1999 Sloan ..... D14/205  
D413,413 S \* 8/1999 Dillon et al. .... D29/112

\* cited by examiner

*Primary Examiner*—Ruth McInroy

(74) *Attorney, Agent, or Firm*—Charles H Schwartz

(57) **CLAIM**

The ornamental design for an ear muff with side mount, as shown and described.

**DESCRIPTION**

FIG. 1 is a front perspective view of an ear muff with side mount showing our new design;  
FIG. 2 is a front elevation view thereof;  
FIG. 3 is a back elevation view thereof;  
FIG. 4 is a side view thereof and opposite side view being a mirror image thereof;  
FIG. 5 is a top plan view thereof; and,  
FIG. 6 is a bottom plan view thereof.

**1 Claim, 2 Drawing Sheets**

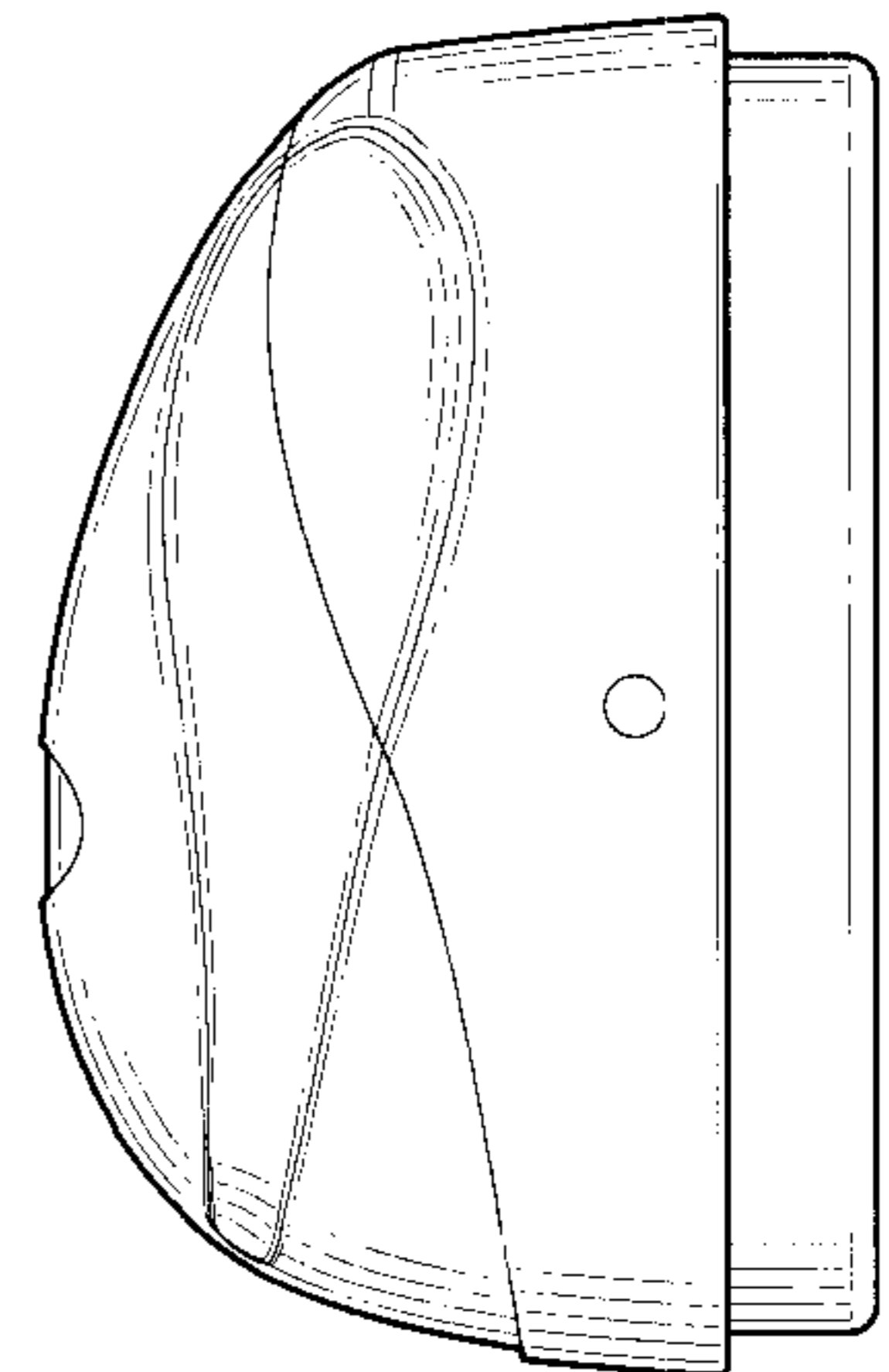
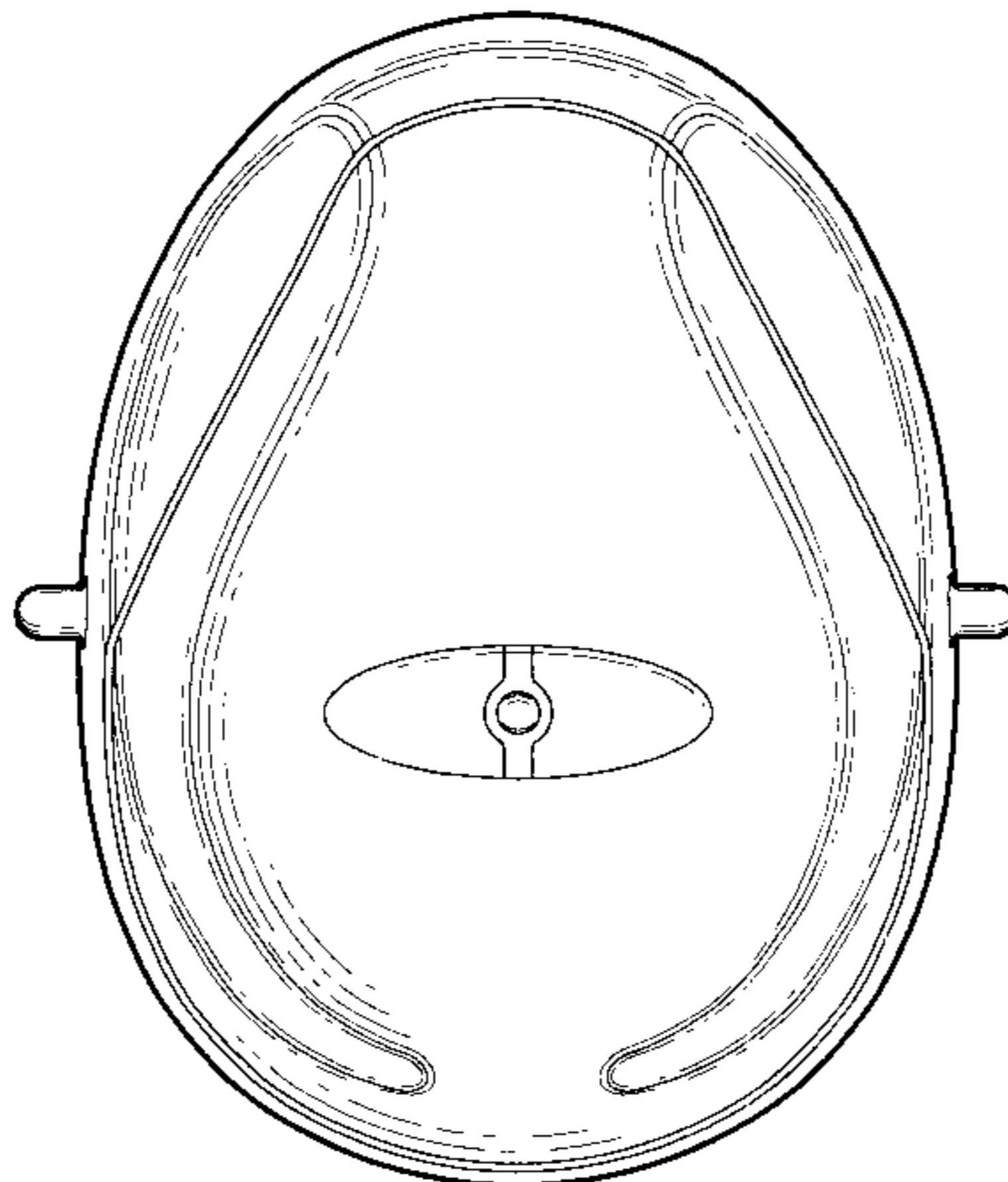
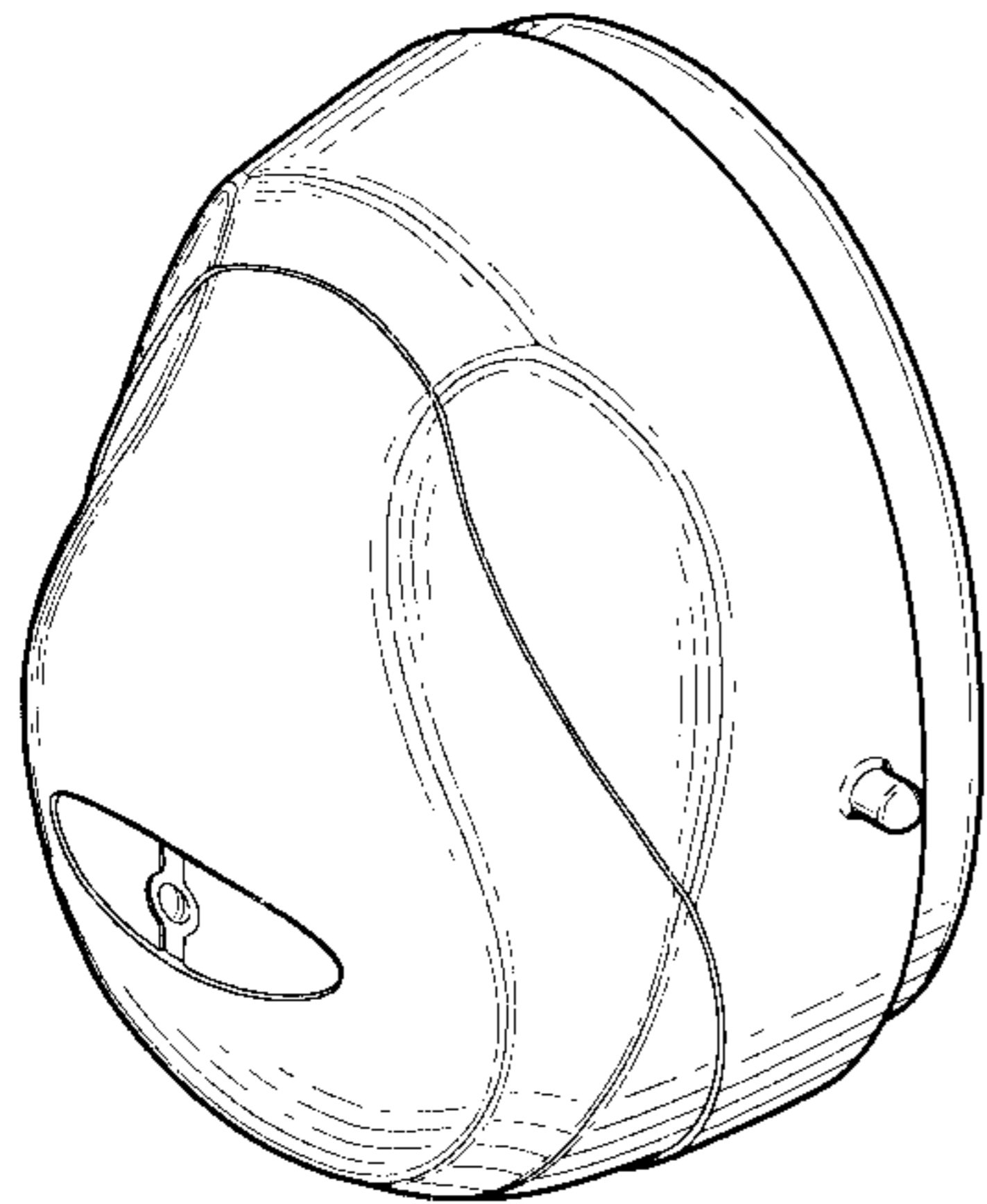

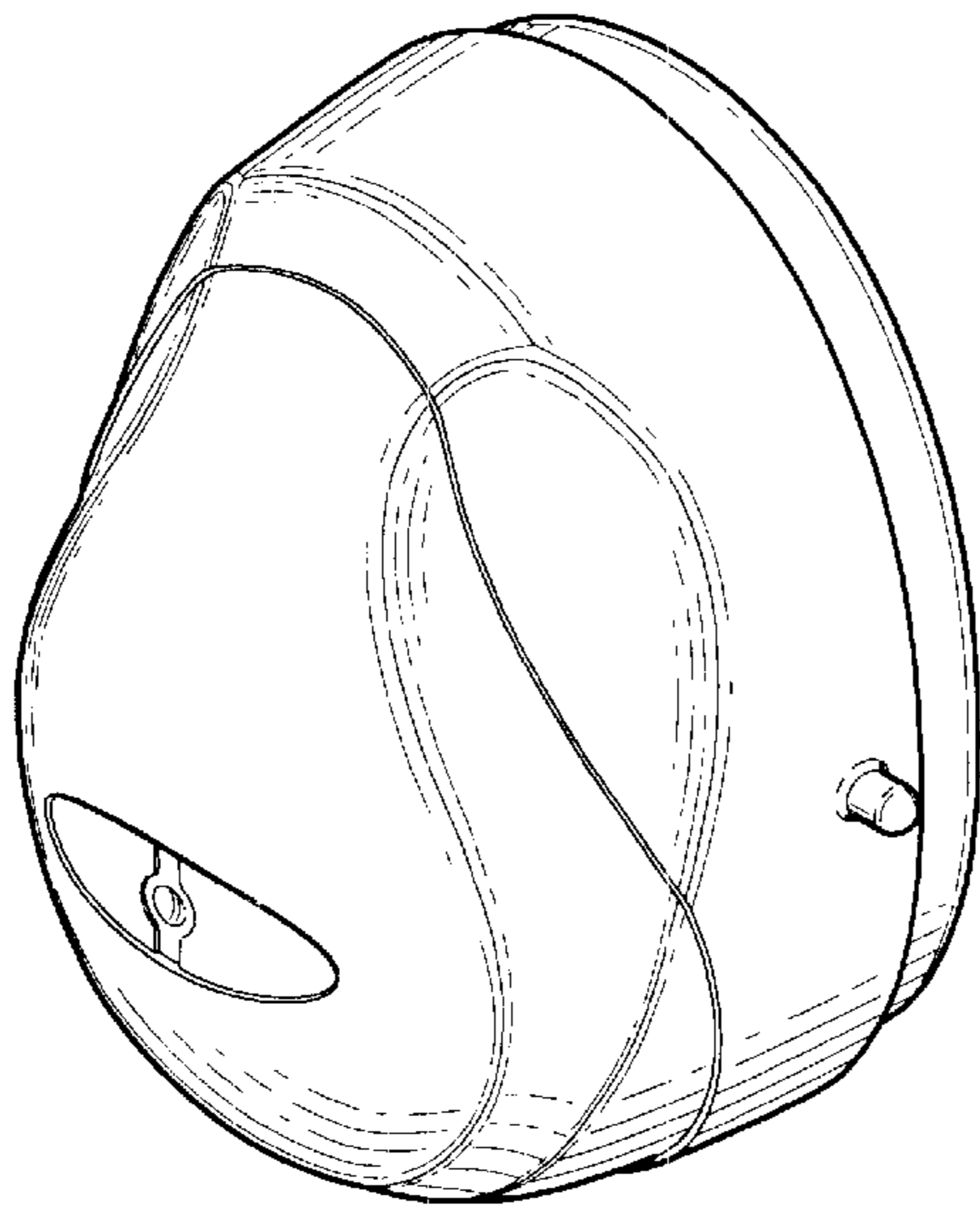

Fig. 1

Fig. 2

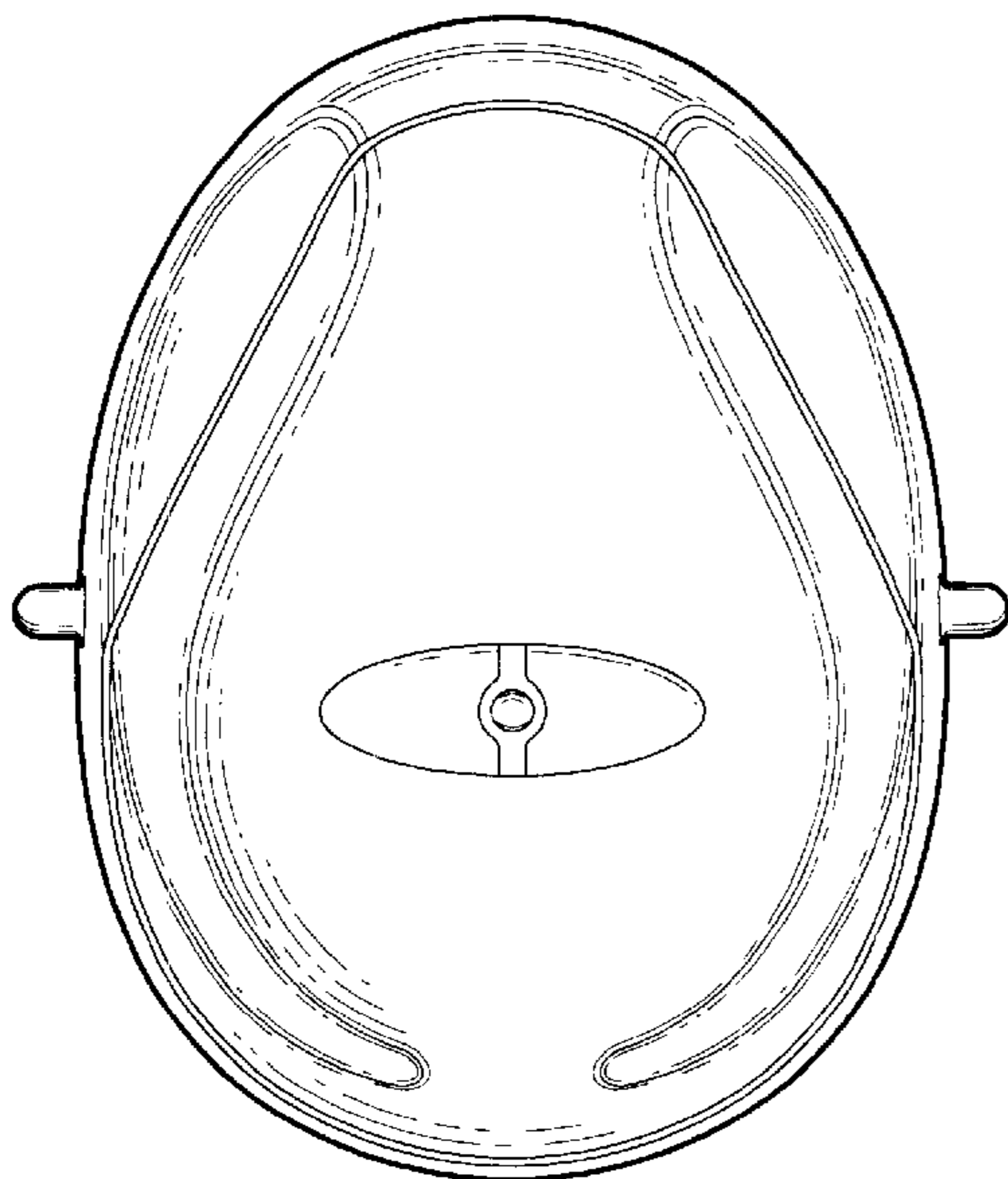
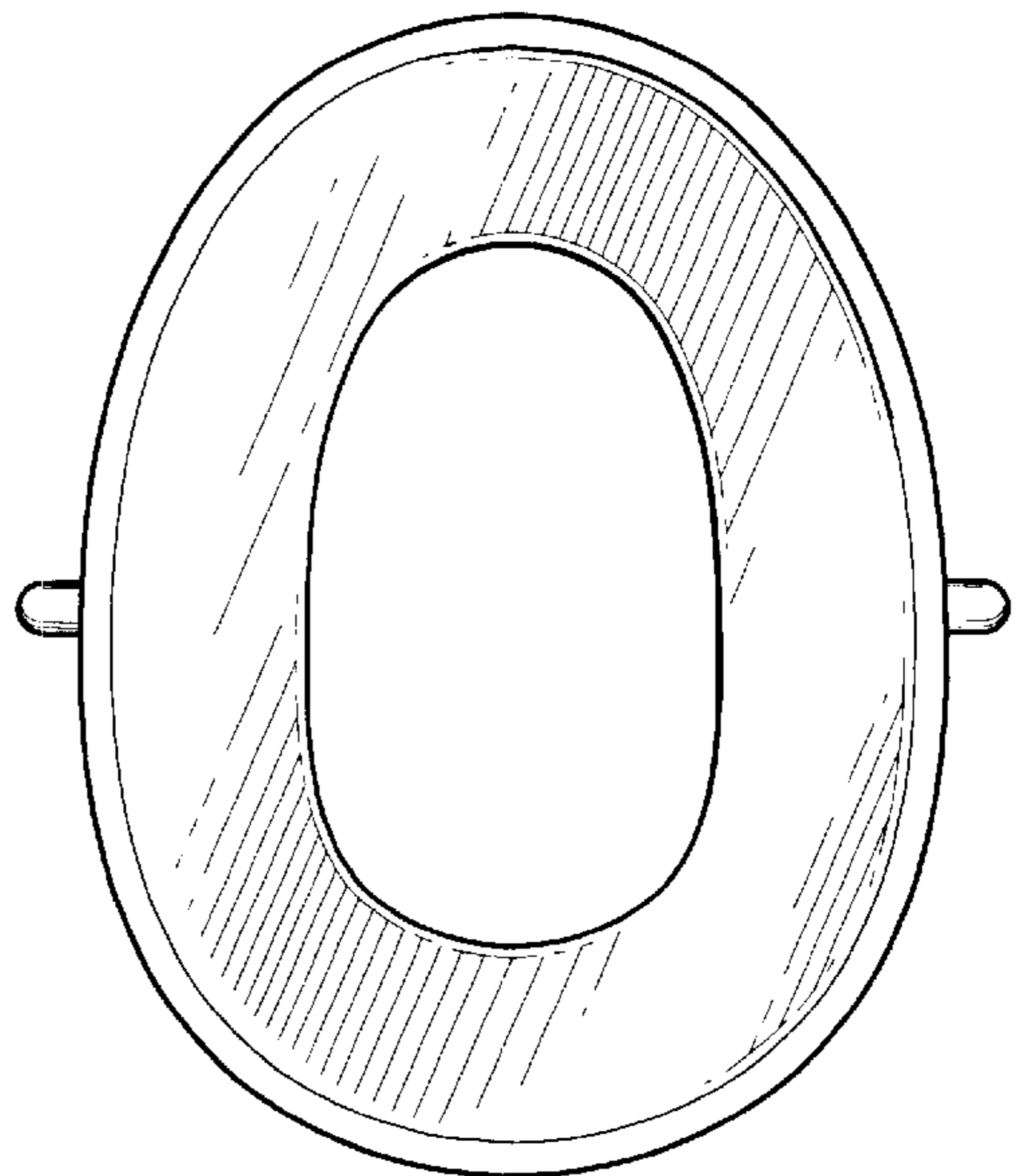

Fig. 3



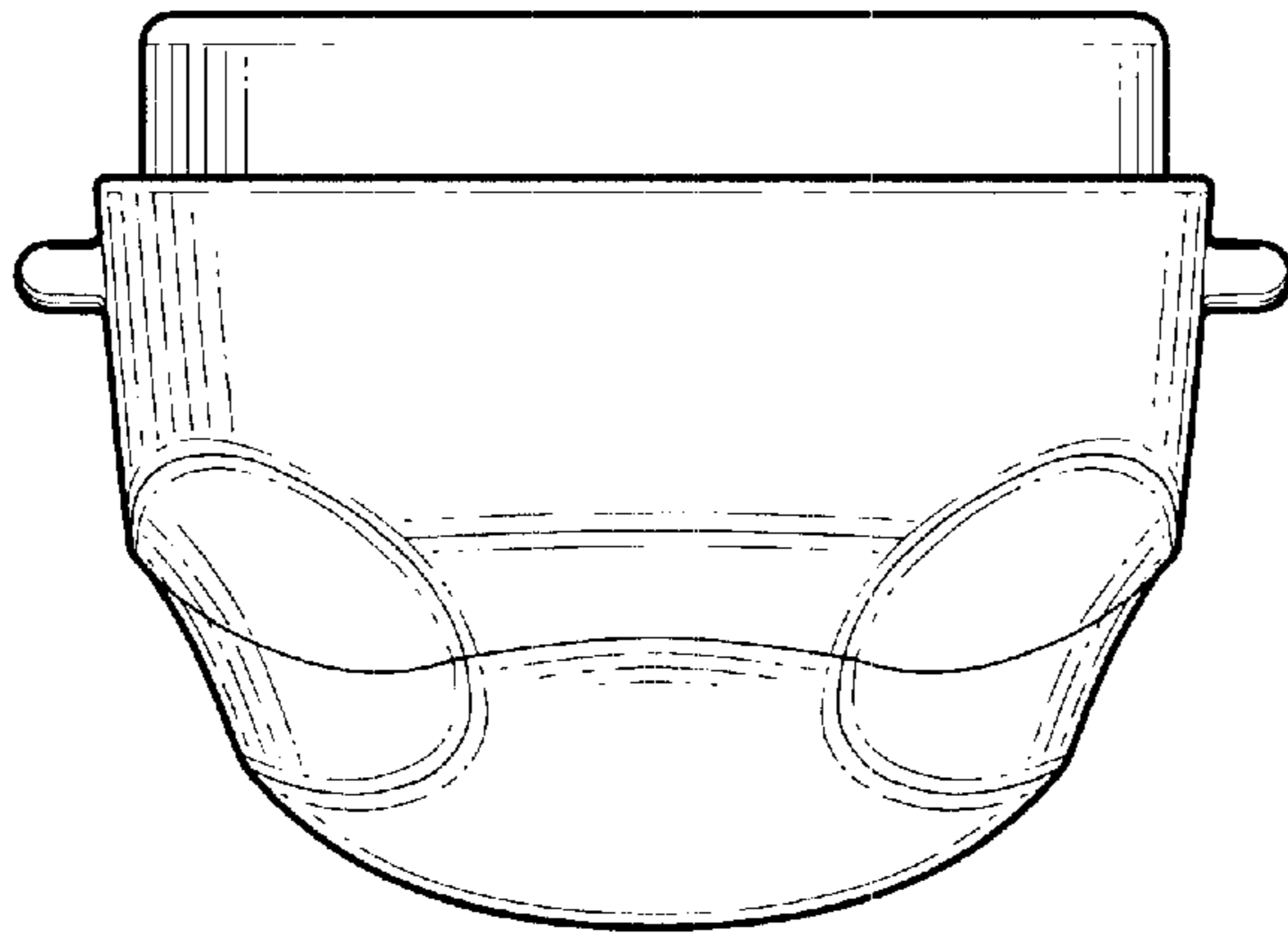

Fig.5

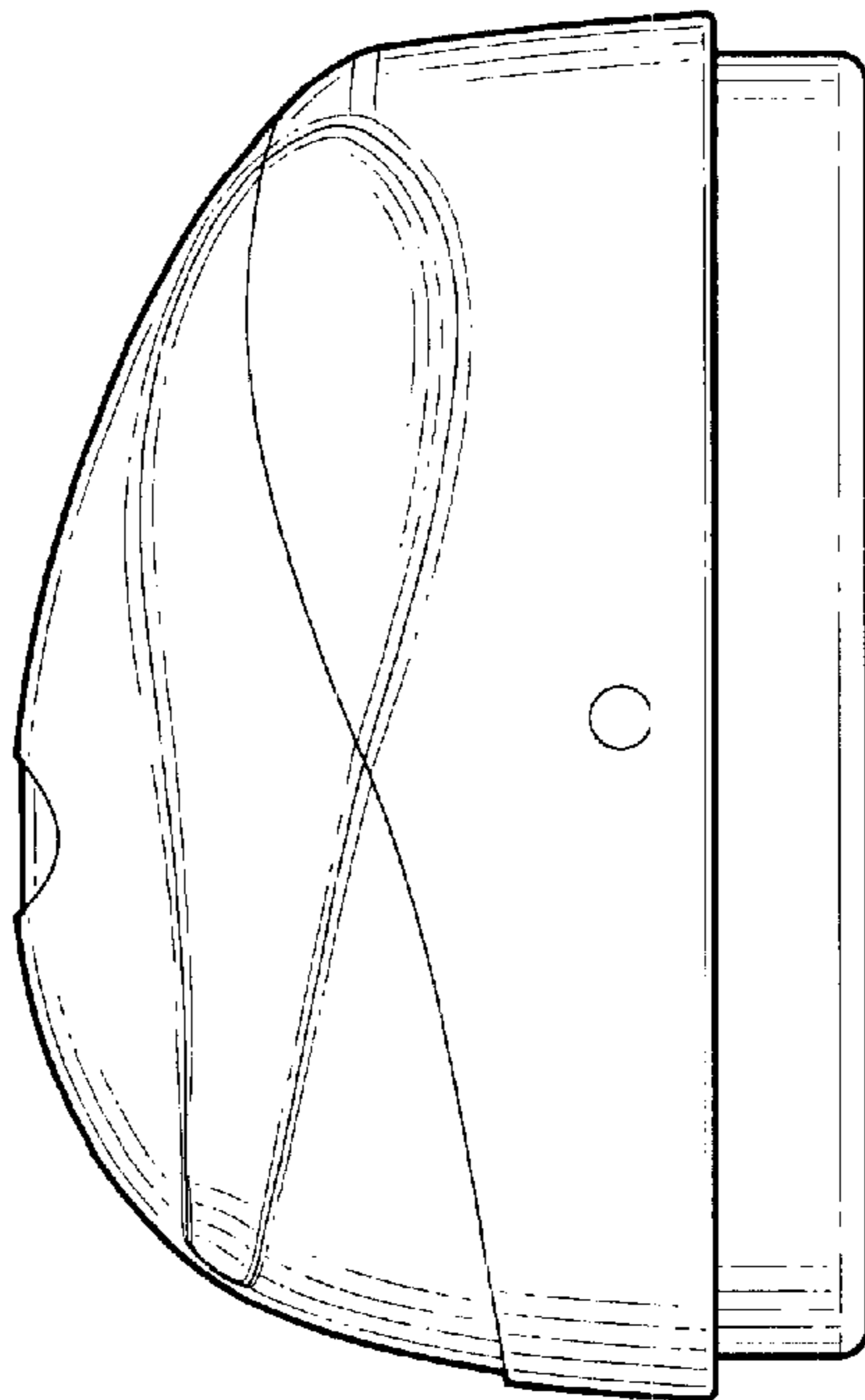

Fig.4

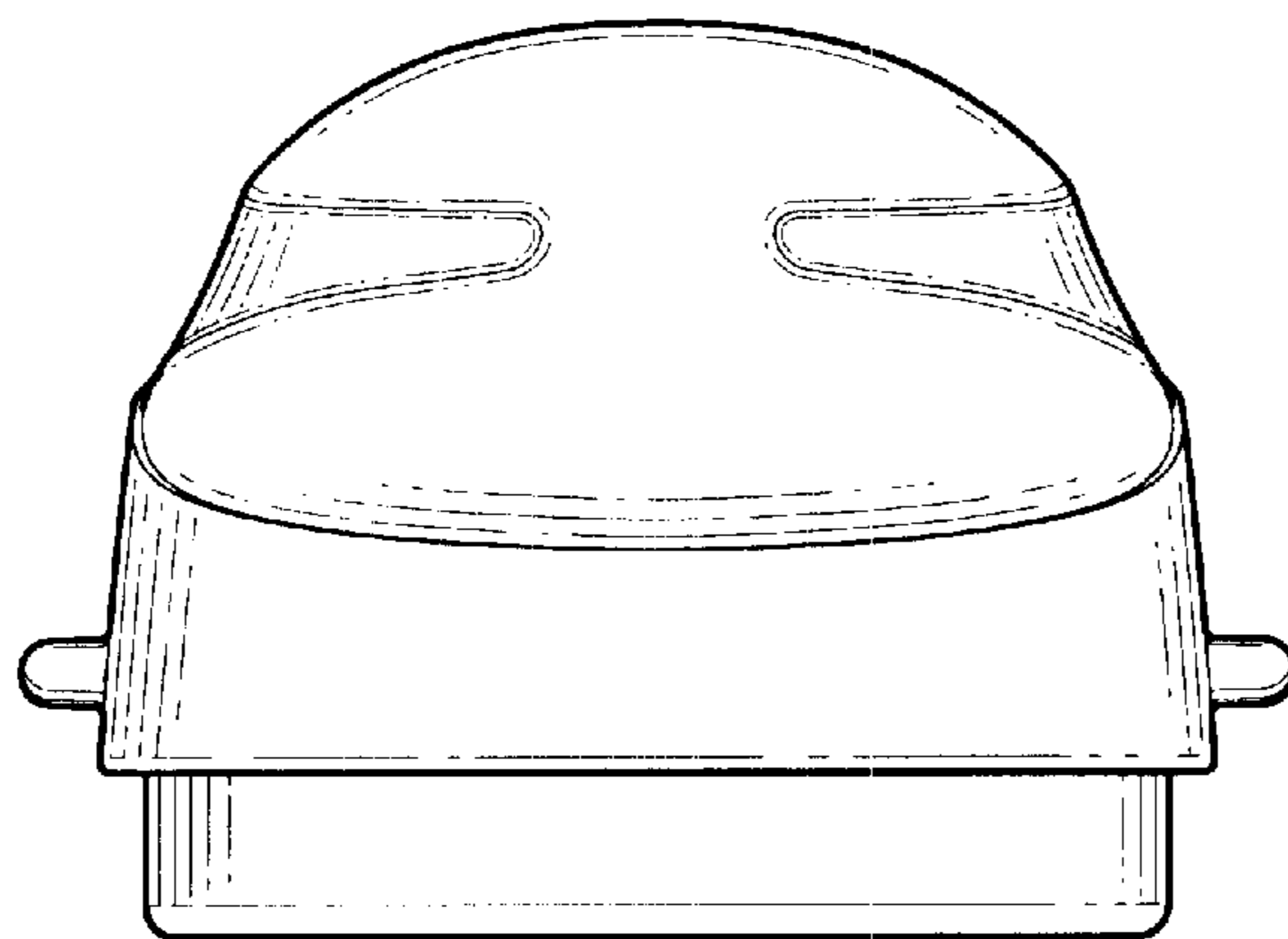

Fig.6