



US00D458990S

(12) **United States Design Patent**
Yamanaka et al.

(10) **Patent No.:** **US D458,990 S**

(45) **Date of Patent:** **** Jun. 18, 2002**

(54) **TOILET SEAT**

D432,220 S * 10/2000 Hulsebus et al. D23/311

(75) Inventors: **Takashi Yamanaka**, Aichi-ken;
Nobuho Miyawaki; **Touichirou Matsuura**, both of Aichi, all of (JP)

OTHER PUBLICATIONS

Copy of TOTO 1999–2000 Catalog, p. 102, Sep. 5, 1999.
Copy of TOTO Washlet Catalog, pp. 1–16, Oct., 2000.

(73) Assignees: **Aisin Seiki Kabushiki Kaisha**, Kariya;
Inax Corporation, Tokoname, both of (JP)

* cited by examiner

(**) Term: **14 Years**

Primary Examiner—Louis S. Zarfes
Assistant Examiner—Robert A. Delehanty
(74) *Attorney, Agent, or Firm*—Burns, Doane, Swecker & Mathis, LLP

(21) Appl. No.: **29/129,554**

(57) **CLAIM**

(22) Filed: **Sep. 18, 2000**

The ornamental design for a toilet seat, as shown and described.

(51) **LOC (7) Cl.** **23-02**

DESCRIPTION

(52) **U.S. Cl.** **D23/311**

(58) **Field of Search** D23/295–300,
D23/303, 309, 311–312; 4/300, 347, 420,
449, 460, 476–477, 234, 237, 667, 242.1

FIG. 1 is a front, top perspective view of a toilet seat showing our new design;
FIG. 2 is a top plan view thereof;
FIG. 3 is a bottom plan view thereof;
FIG. 4 is a front end elevational view thereof;
FIG. 5 is a rear end elevational view thereof;
FIG. 6 is a right side elevational view thereof;
FIG. 7 is a left side elevational view thereof; and,
FIG. 8 is a front, top perspective view of the toilet seat shown in FIG. 1 when in an alternative position; and,
FIG. 9 is a side elevational view thereof.

(56) **References Cited**

U.S. PATENT DOCUMENTS

- 3,590,401 A * 7/1971 Brown D23/311 X
- D262,733 S * 1/1982 Bjorn D23/311
- D318,525 S * 7/1991 Bock D23/311
- D348,926 S * 7/1994 Rasmussen D23/311
- D353,659 S * 12/1994 Hall D23/311
- D355,246 S * 2/1995 Kawamura et al. D23/311 X
- D402,740 S * 12/1998 Ochi et al. D23/311

1 Claim, 4 Drawing Sheets

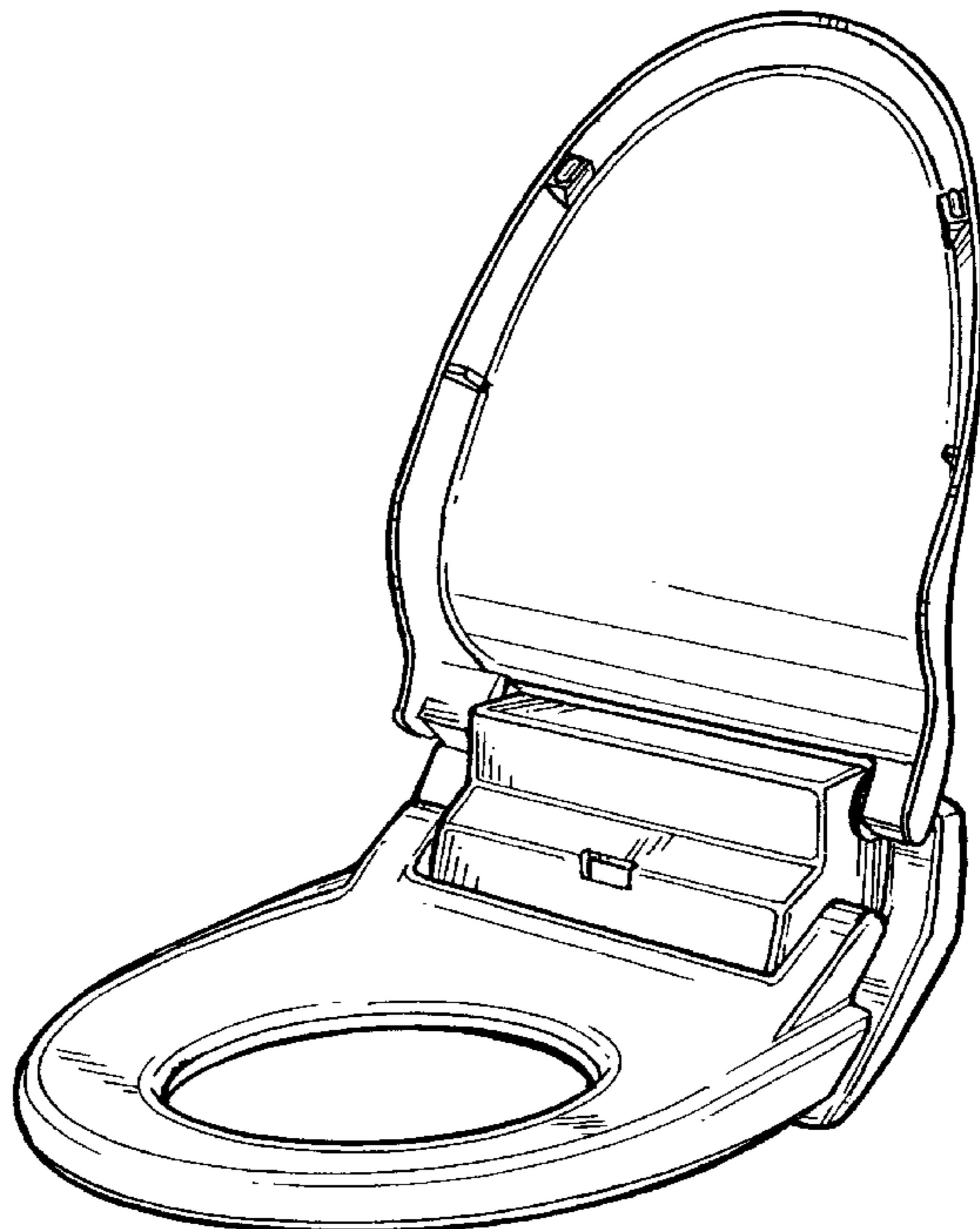
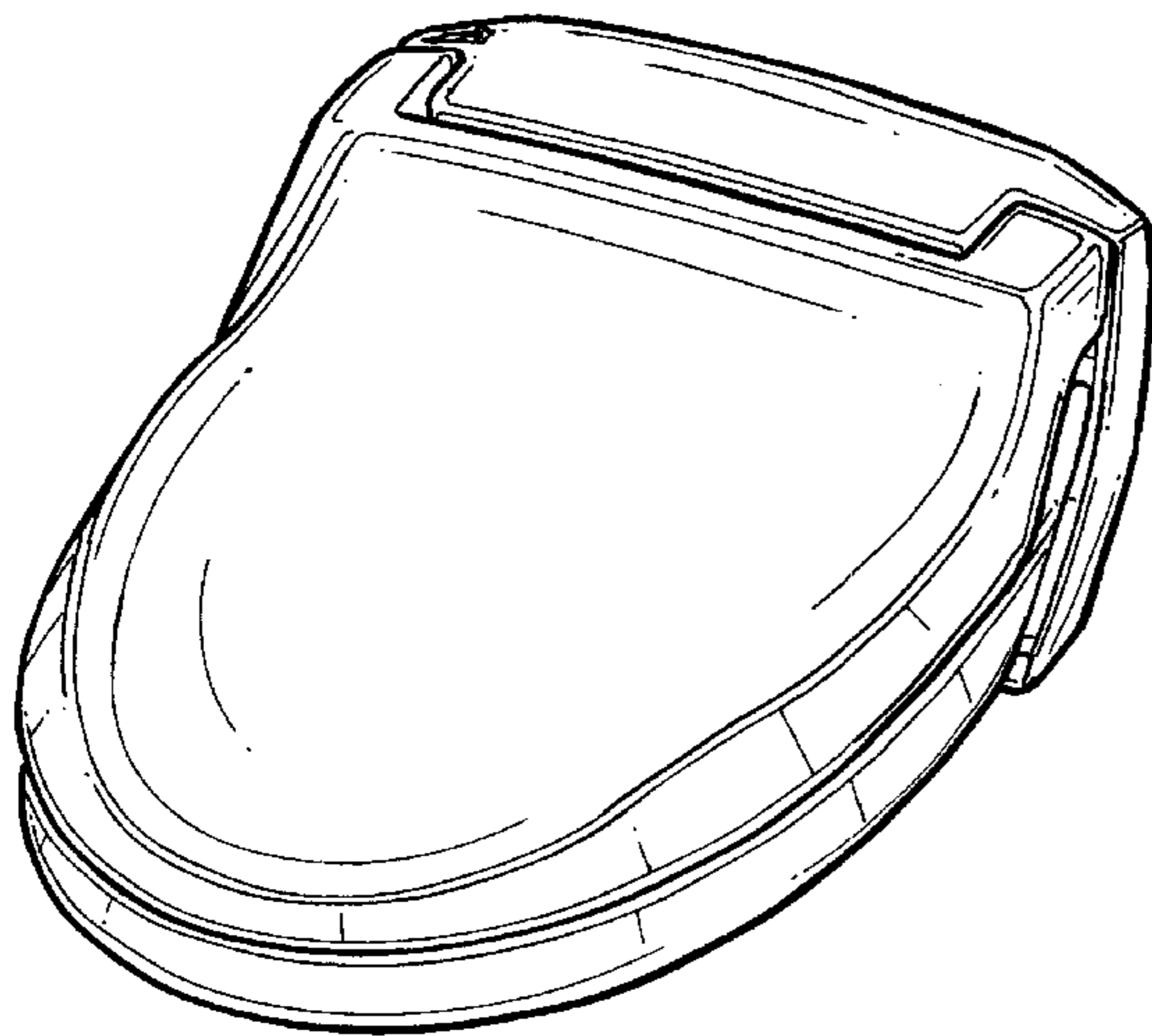

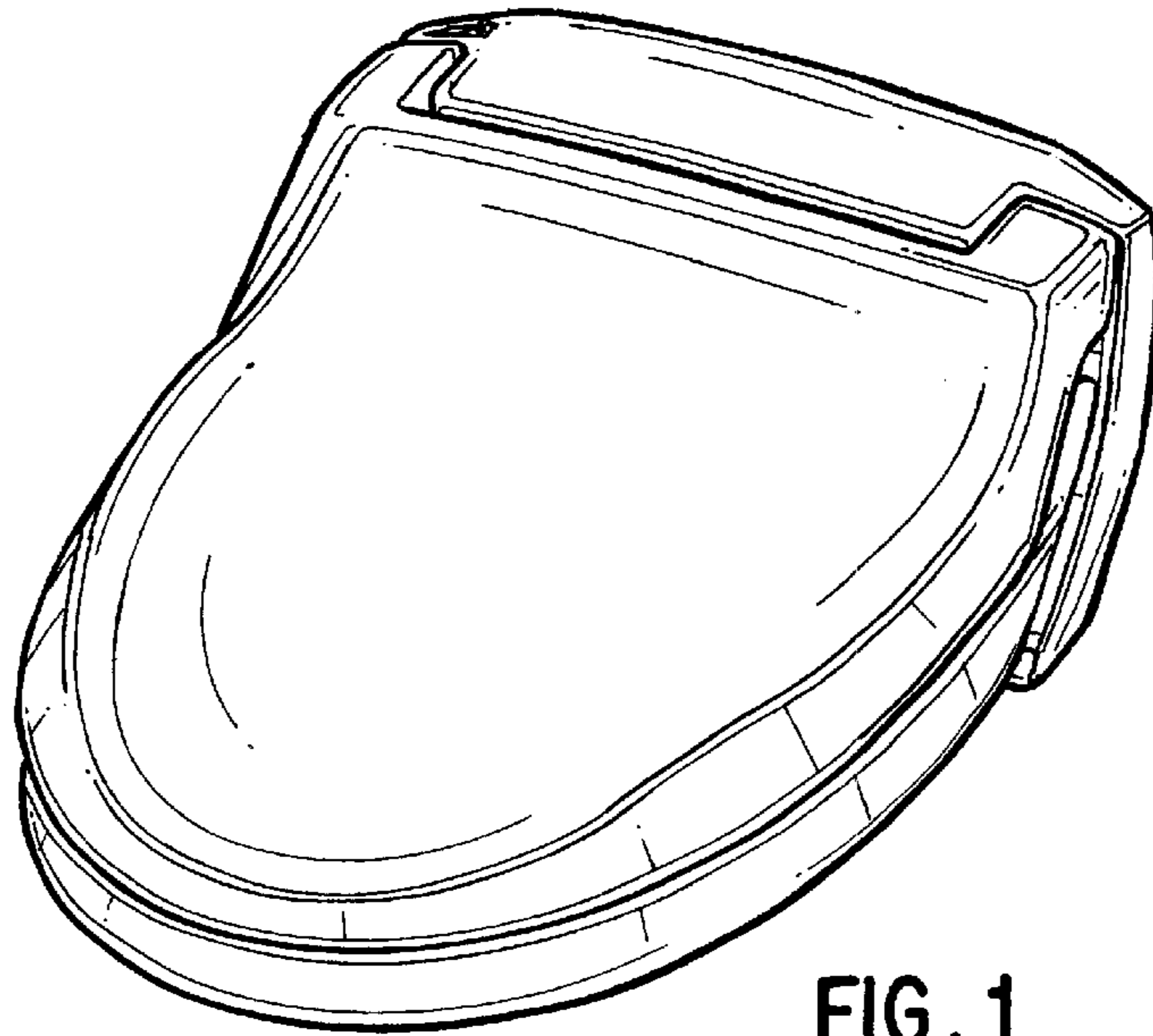

FIG. 1

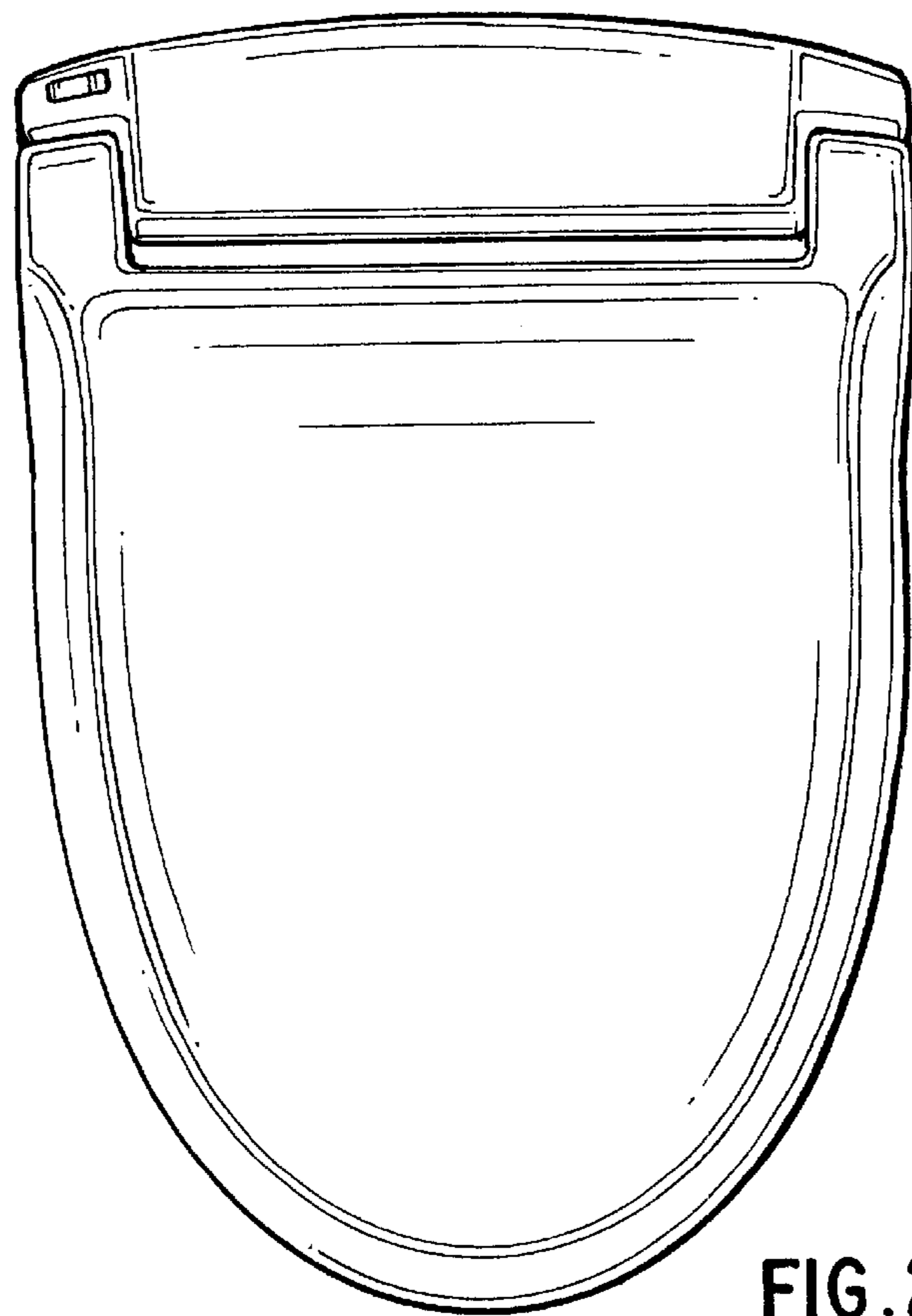

FIG. 2

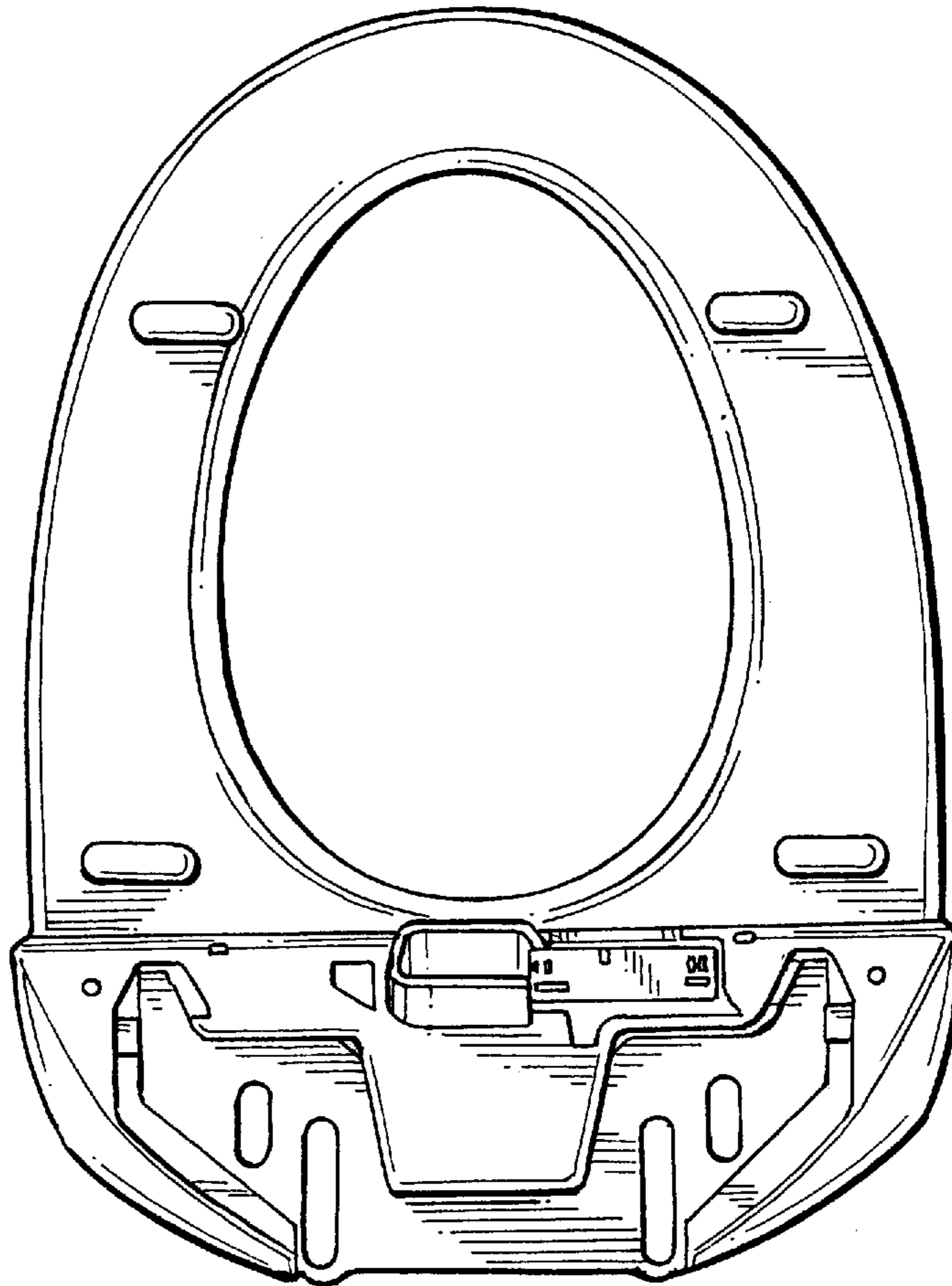

FIG. 3

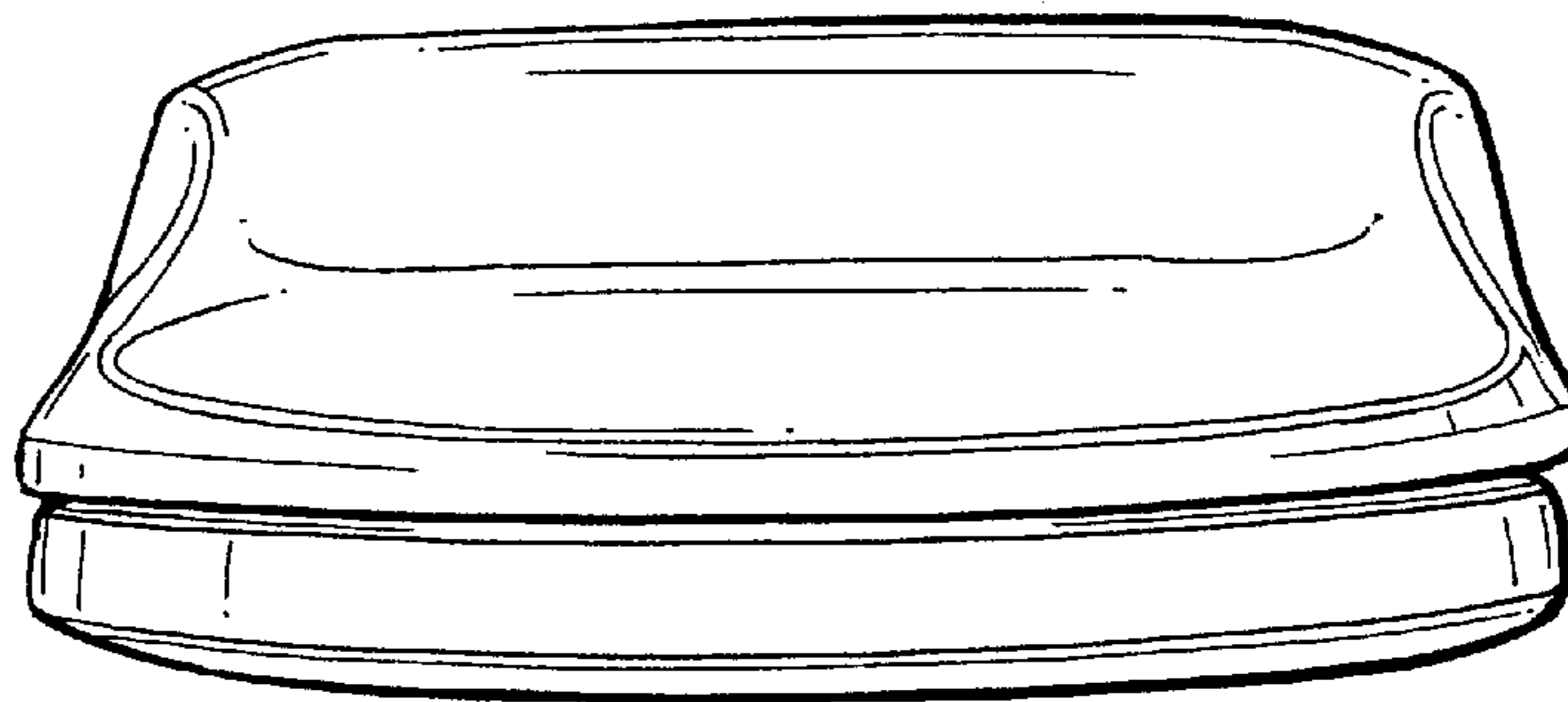

FIG. 4

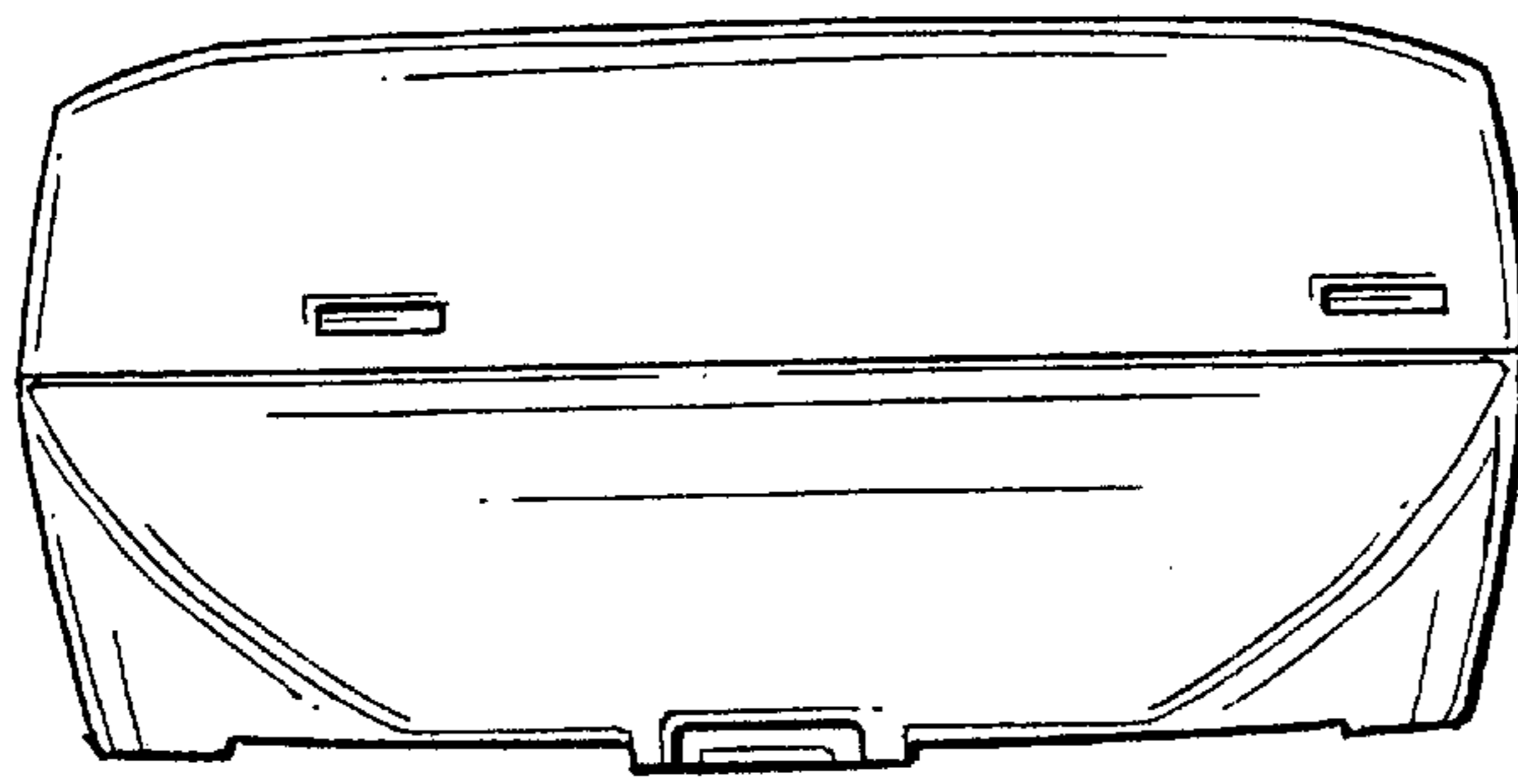

FIG. 5

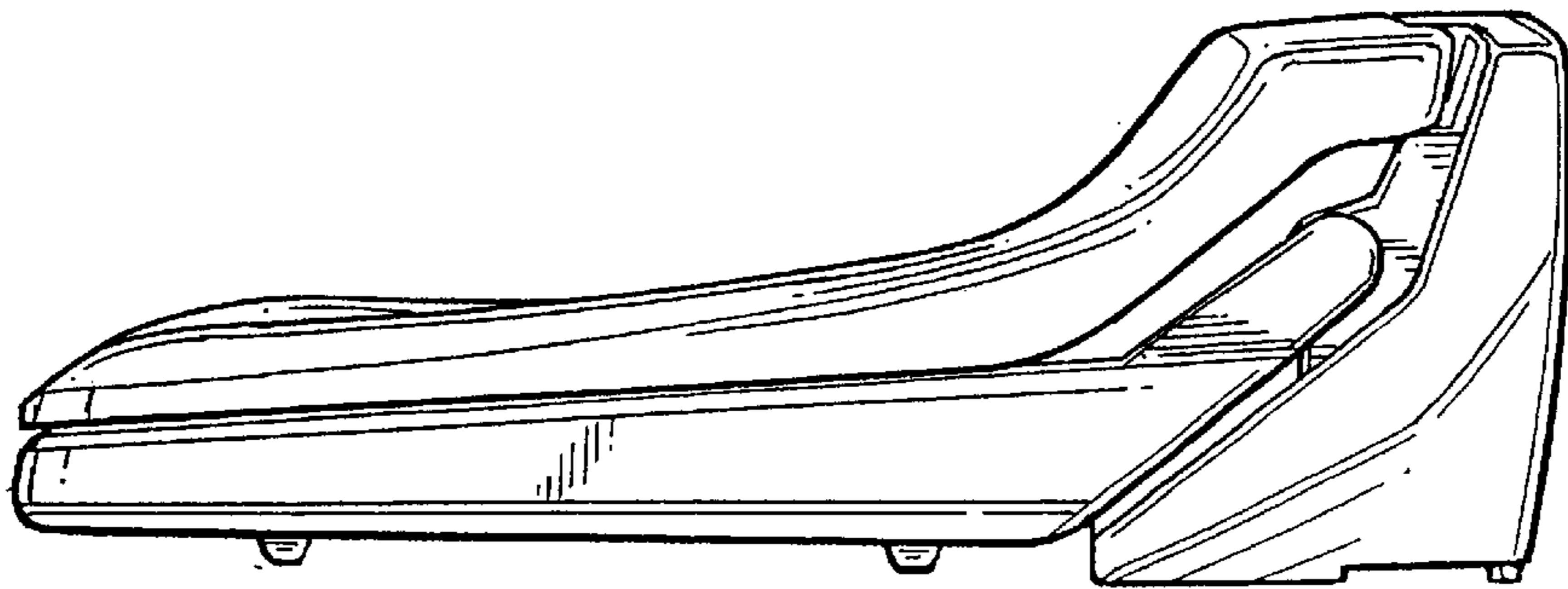

FIG. 6

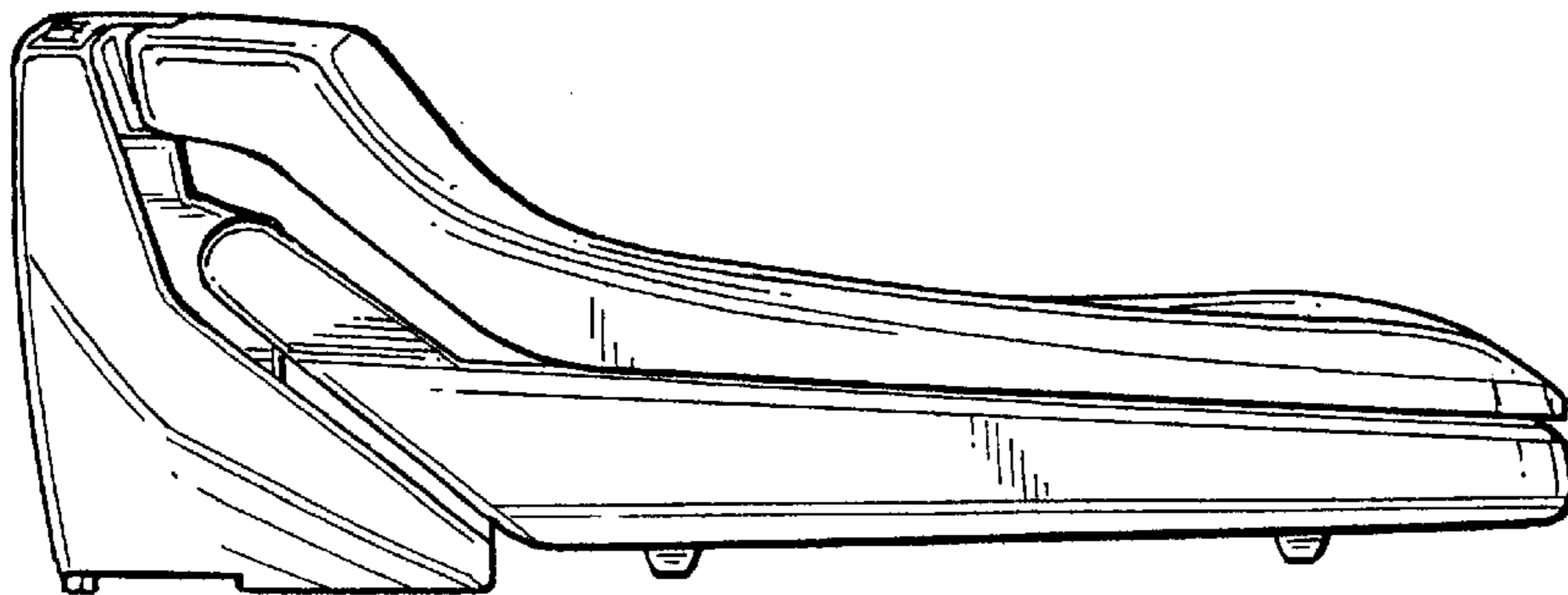

FIG. 7

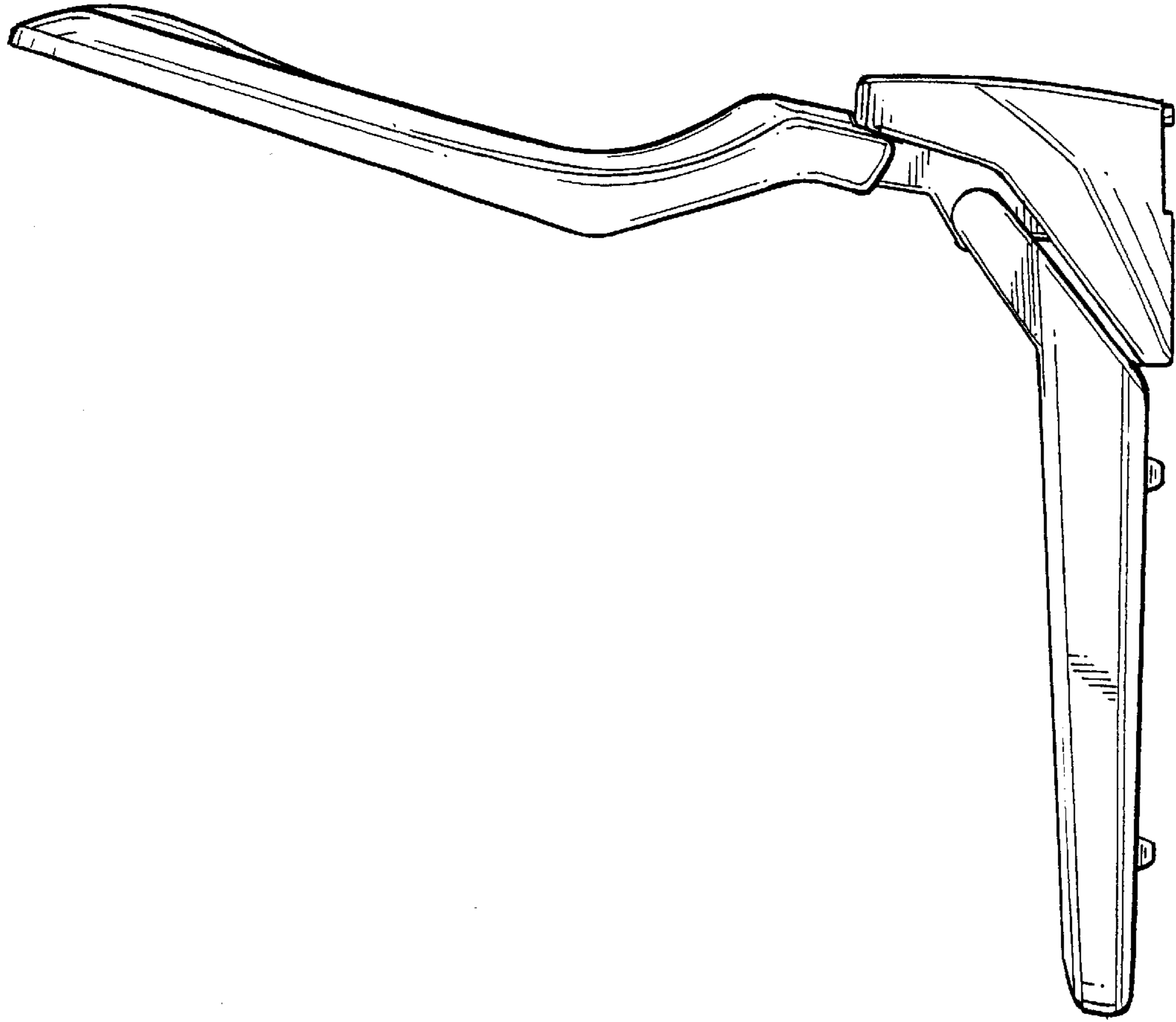

FIG. 9

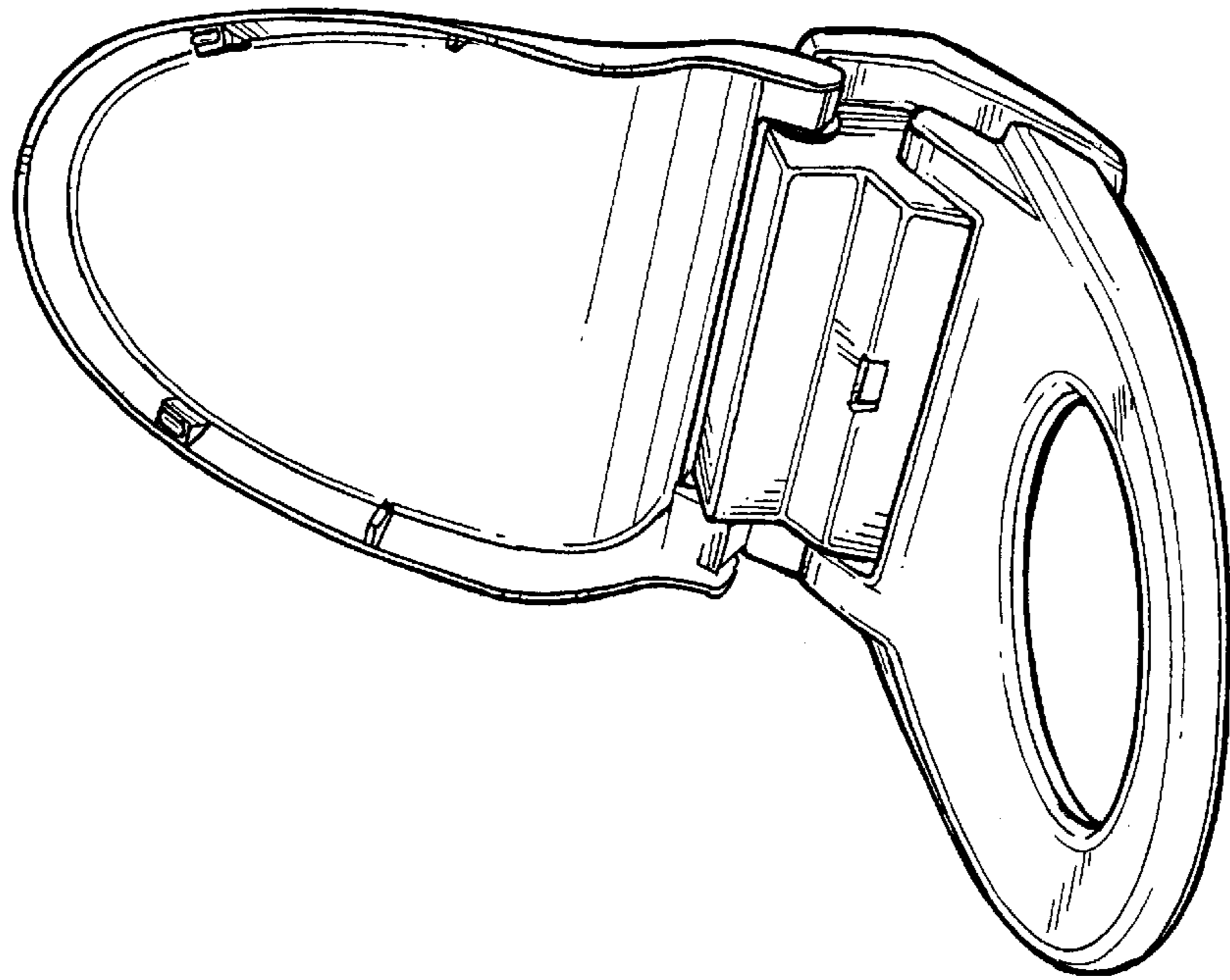

FIG. 8