



US00D458841S

(12) **United States Design Patent**
Goguen et al.

(10) **Patent No.:** **US D458,841 S**
(45) **Date of Patent:** **** Jun. 18, 2002**

(54) **MULTIMEDIA DISTRIBUTION PACKAGE**

(75) Inventors: **George J. Goguen**, Warren, VT (US);
Jonathan Daniel McVey, Portland, OR (US)

(73) Assignee: **Saga Software, Inc.**, Reston, VA (US)

(**) Term: **14 Years**

(21) Appl. No.: **29/117,106**

(22) Filed: **Jan. 10, 2000**

Related U.S. Application Data

(63) Continuation-in-part of application No. 29/106,568, filed on Jun. 16, 1999.

(51) **LOC (7) Cl.** **09-07**

(52) **U.S. Cl.** **D9/432**

(58) **Field of Search** D9/432, 414, 416,
D9/419, 426; 206/216, 218, 223, 307, 307.1,
459.5; 220/9.1, 9.2, 9.3, 9.4, 62; 229/100,
103.2, 103.3, 104, 117, 117.01, 220.01,
122.28, 185

(56) **References Cited**

U.S. PATENT DOCUMENTS

2,031,381 A * 2/1936 McCallum 206/47
2,828,905 A * 4/1958 Frizzell 229/45

(List continued on next page.)

Primary Examiner—Ted Shooman

Assistant Examiner—Daniel Bui

(74) *Attorney, Agent, or Firm*—Venable; James R. Burdett

(57) **CLAIM**

The ornamental design for a multimedia distribution package, as shown and described.

DESCRIPTION

FIG. 1 is an outside view, shown in perspective, of a multimedia distribution package according to the present invention;

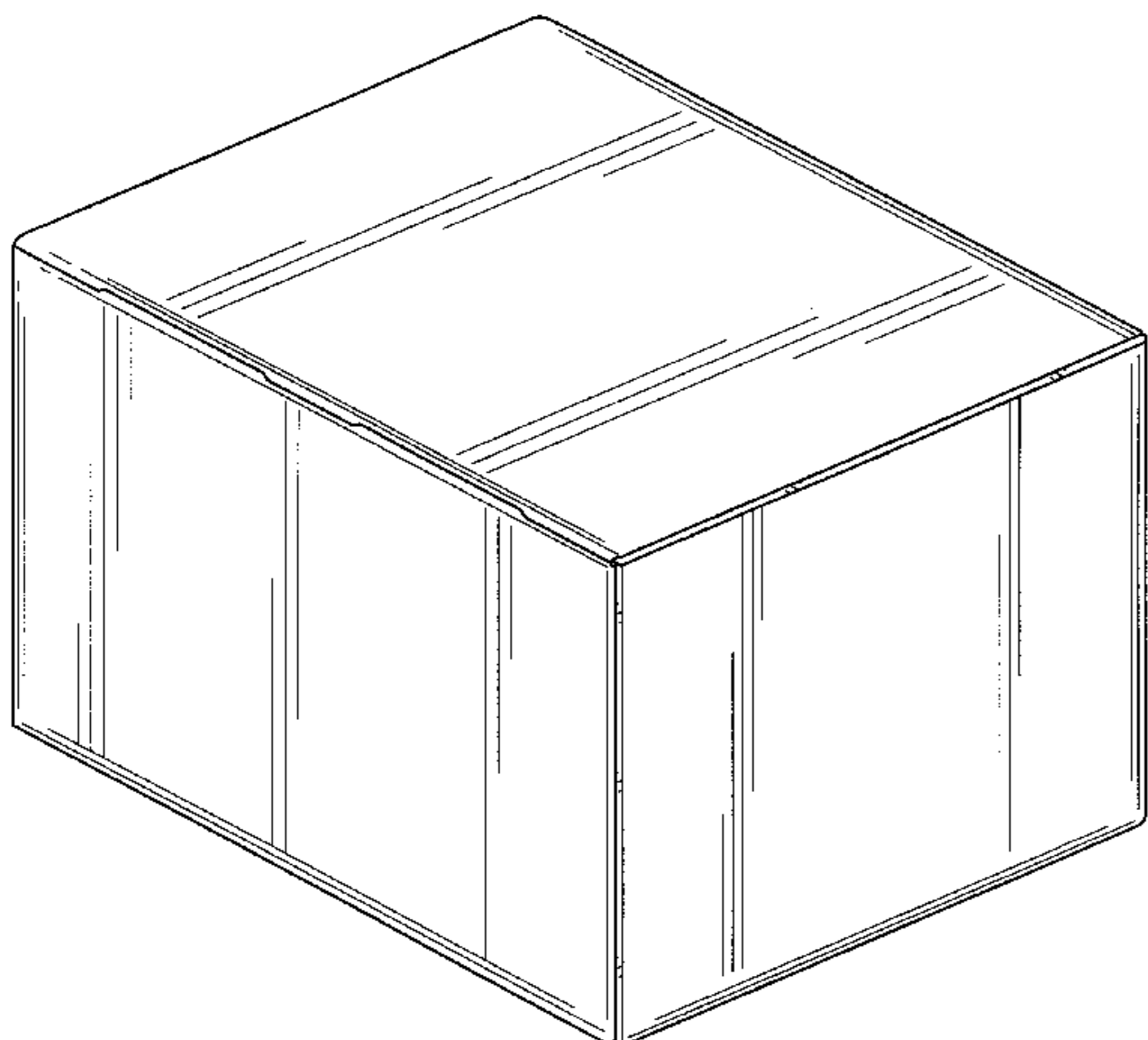

FIG. 2 is a top plan view of the multimedia distribution package shown in FIG. 1;

FIG. 3 is a bottom plan view of the multimedia distribution package shown in FIG. 1;

FIG. 4 is a right side elevation view of the multimedia distribution package shown in FIG. 1;

FIG. 5 is a left side elevation view of the multimedia distribution package shown in FIG. 1;

FIG. 6 is a front elevation view of the multimedia distribution package shown in FIG. 1;

FIG. 7 is a back elevation view of the multimedia distribution package shown in FIG. 1;

FIG. 8 is a perspective view of a bottom portion of the multimedia distribution package shown in FIG. 1, with a top portion of the multimedia distribution package having been removed to display the computer software and documentation held in place by a packaging insert;

FIG. 9 is a top plan view of the multimedia distribution package shown in FIG. 8;

FIG. 10 is a bottom plan view of the multimedia distribution package shown in FIG. 8;

FIG. 11 is a right side elevation view of the multimedia distribution package shown in FIG. 8;

FIG. 12 is a left side elevation view of the multimedia distribution package shown in FIG. 8;

FIG. 13 is a front elevation view of the multimedia distribution package shown in FIG. 8;

FIG. 14 is a back elevation view of the multimedia distribution package shown in FIG. 8;

FIG. 15 is an enlarged perspective view of the packaging insert shown in FIGS. 8 and 9, the packaging insert as being shown separately in FIGS. 15–21 for clarity of illustration.

FIG. 16 is a top plan view of the packaging insert shown in FIG. 15;

FIG. 17 is a bottom plan view of the packaging insert shown in FIG. 15;

FIG. 18 is a right side elevation view of the packaging insert shown in FIG. 15;

FIG. 19 is a left side elevation view of the packaging insert shown in FIG. 15;

FIG. 20 is a front elevation view of the packaging insert shown in FIG. 15; and,

FIG. 21 is a back elevation view of the packaging insert shown in FIG. 15.

The broken line showing of environment is for illustrative purposes only and forms no part of the claimed design.

1 Claim, 15 Drawing Sheets

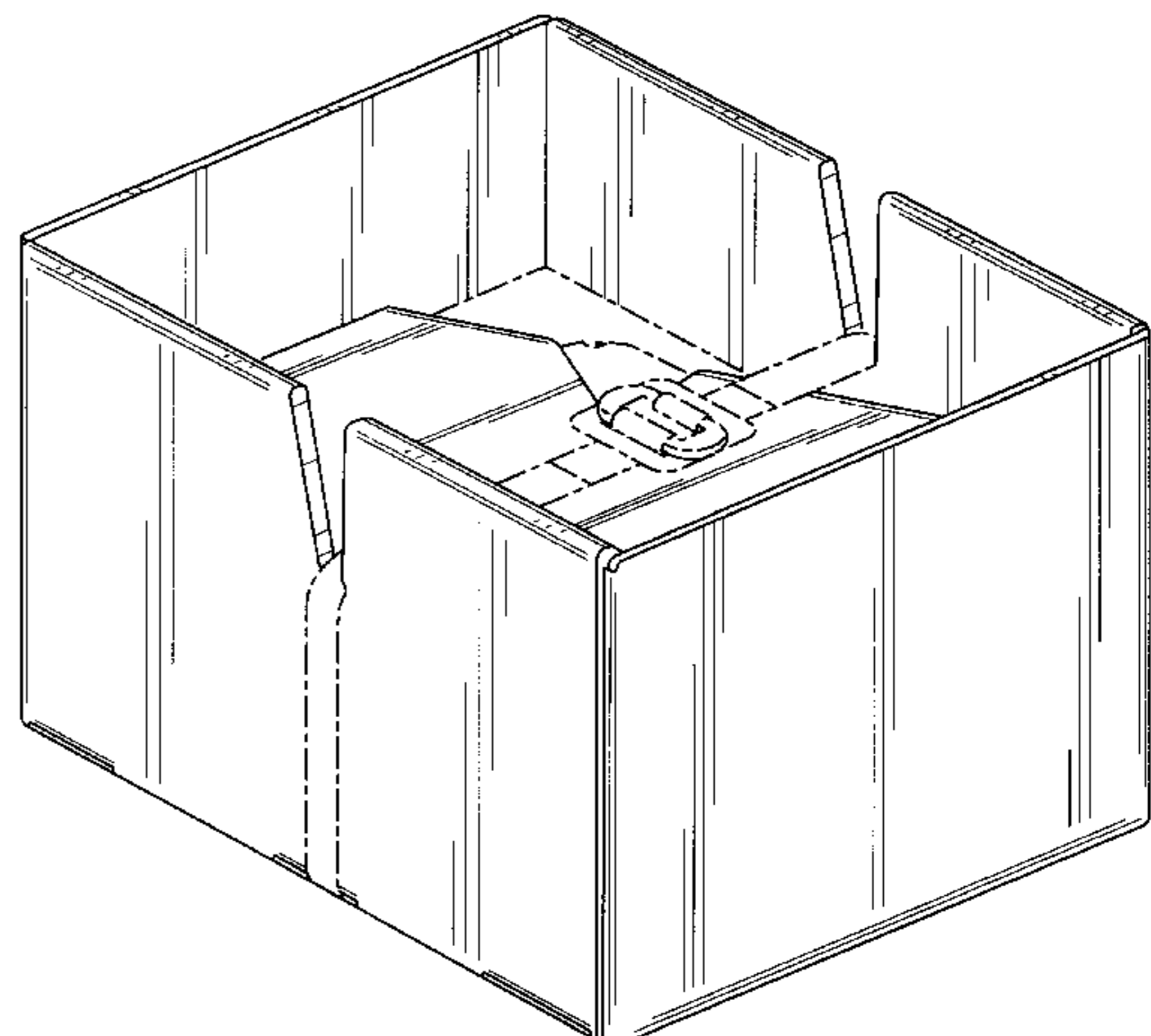

US D458,841 S

Page 2

U.S. PATENT DOCUMENTS				
		5,921,398 A	* 7/1999 Carroll	206/736
4,416,376 A	* 11/1983 Scheffers et al.	6,056,121 A	* 5/2000 Olson	206/577
D383,063 S	* 9/1997 Koenig	6,135,289 A	* 10/2000 Miller	206/774
5,915,548 A	* 6/1999 Sasaki			
			* cited by examiner	

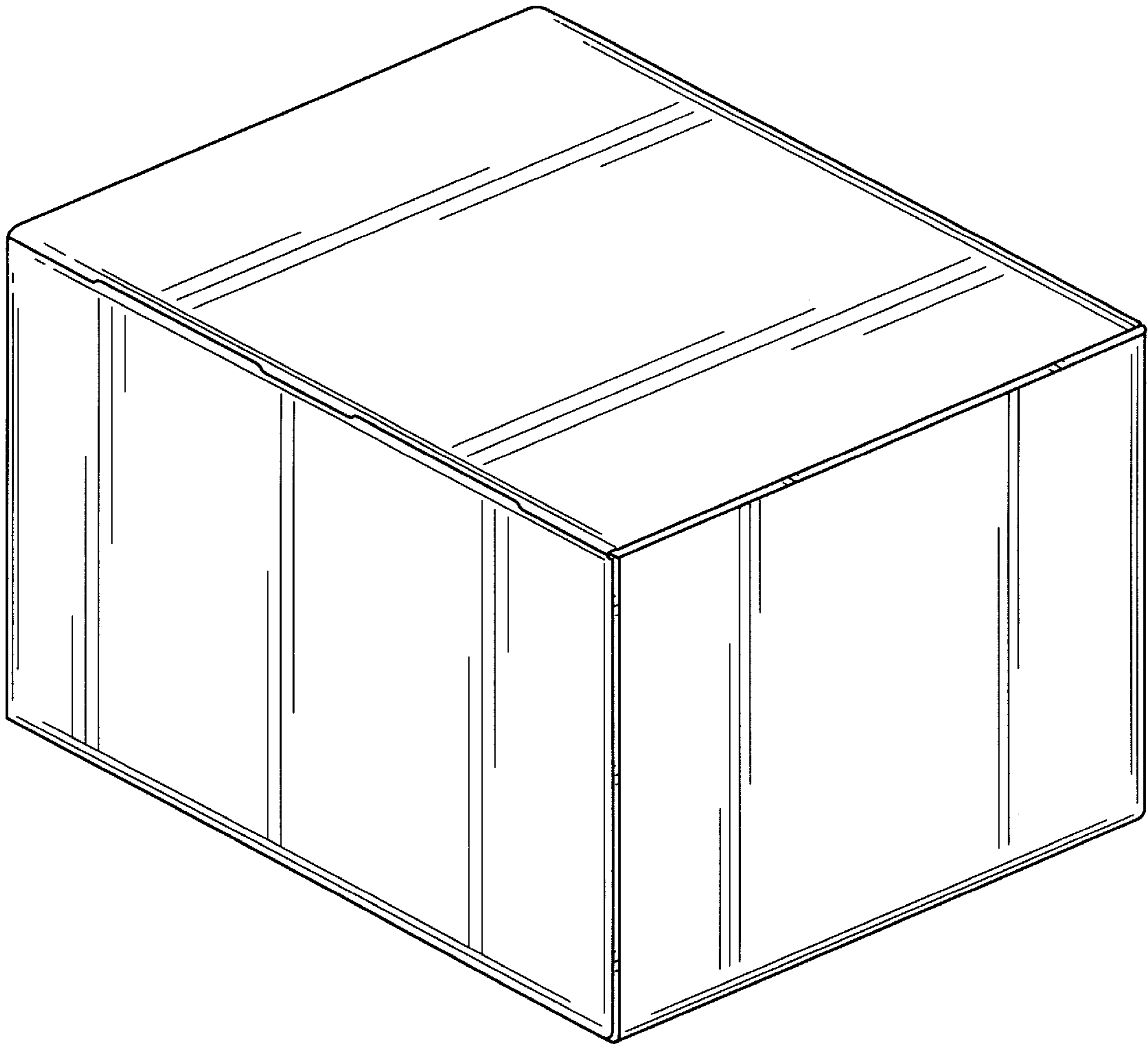

FIG. 1

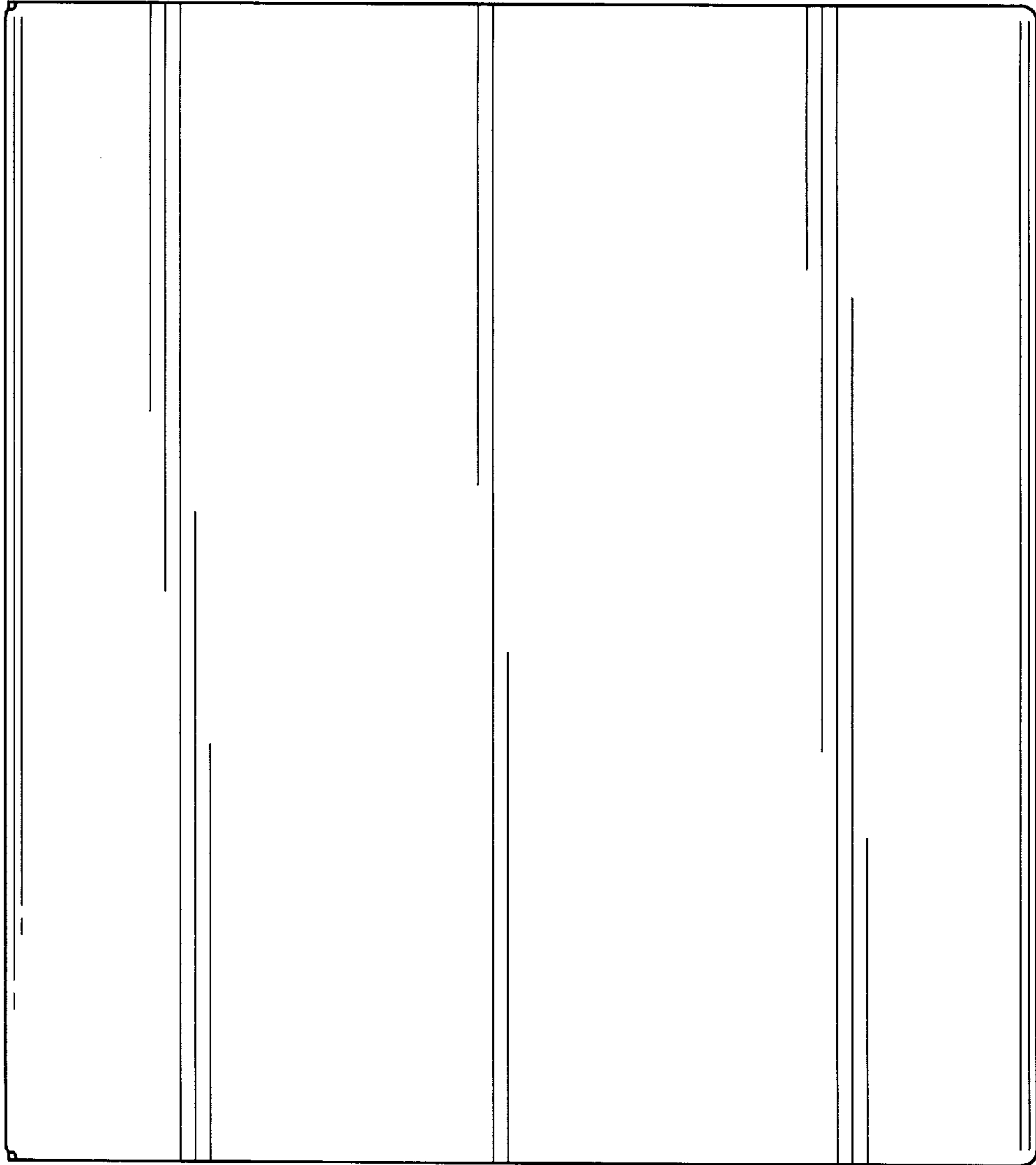

FIG. 2

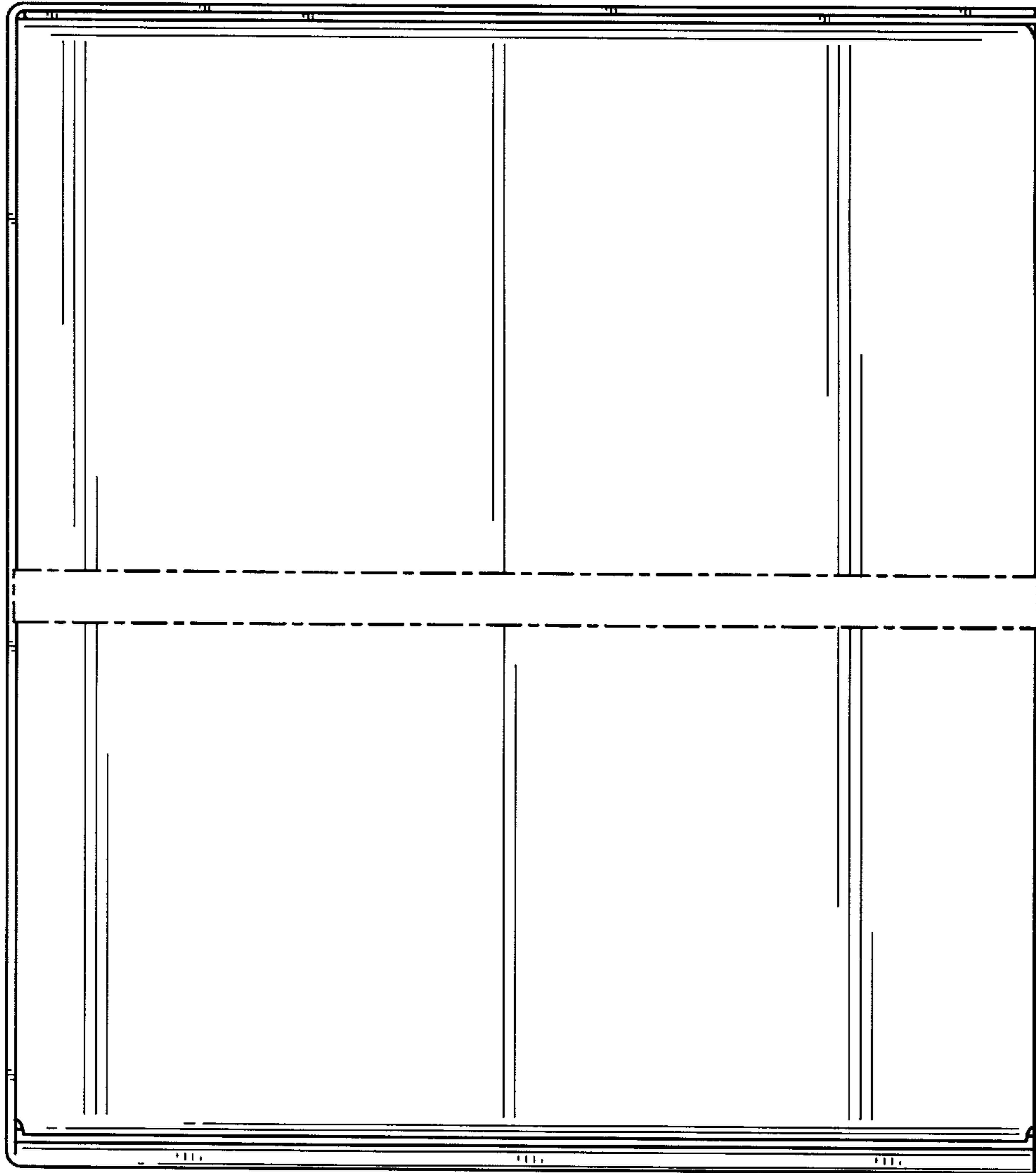

FIG. 3

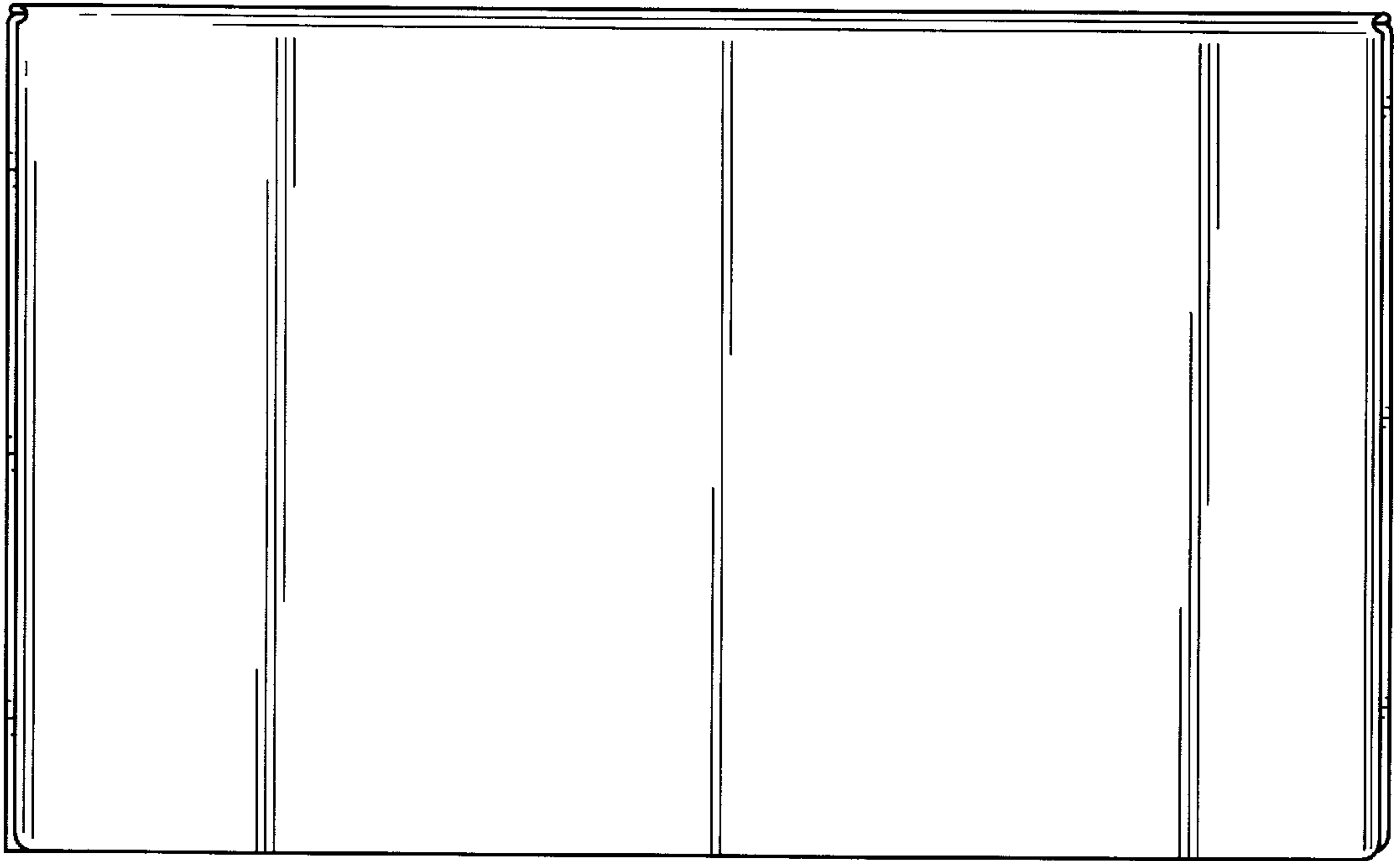

FIG. 4

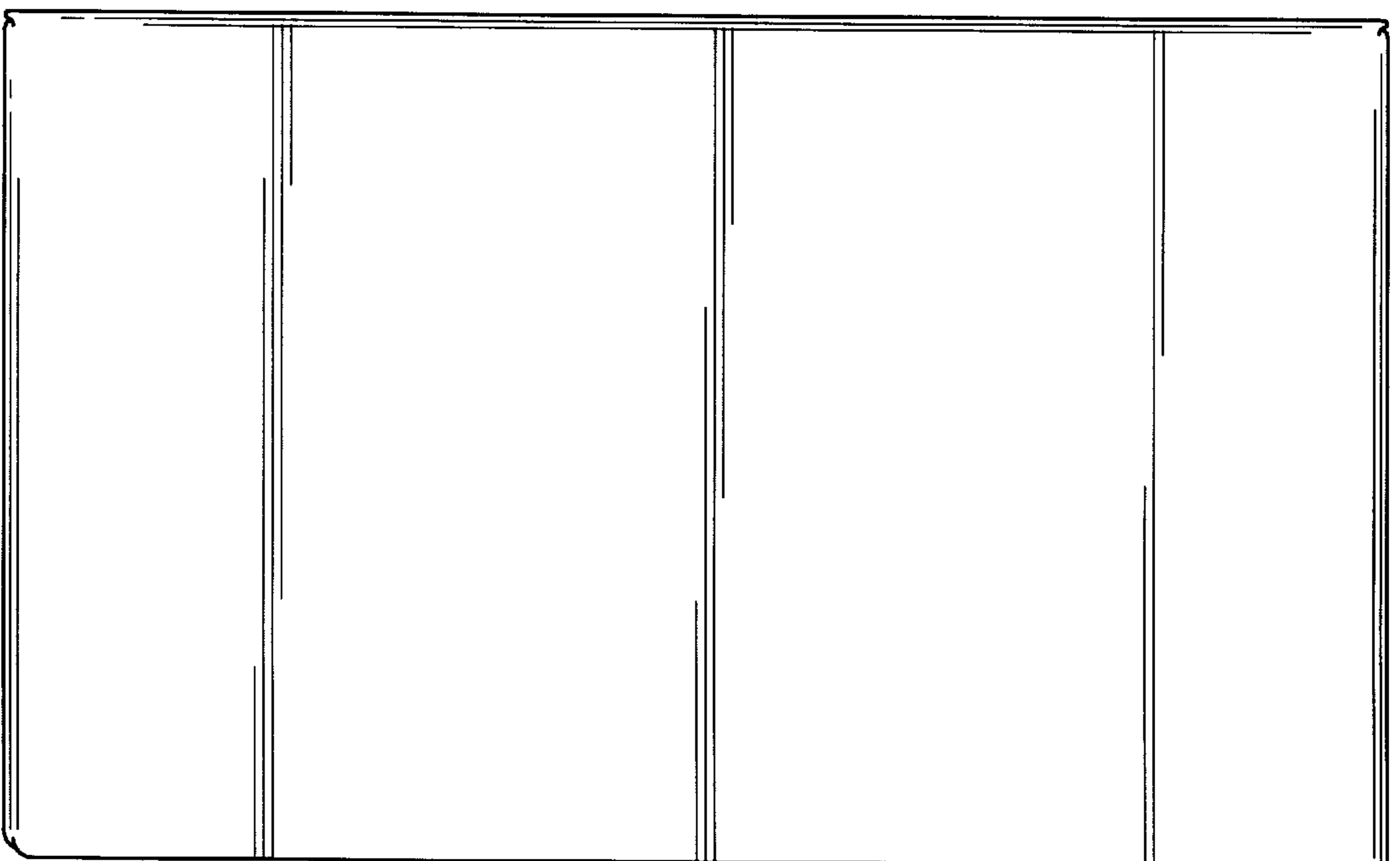

FIG. 5

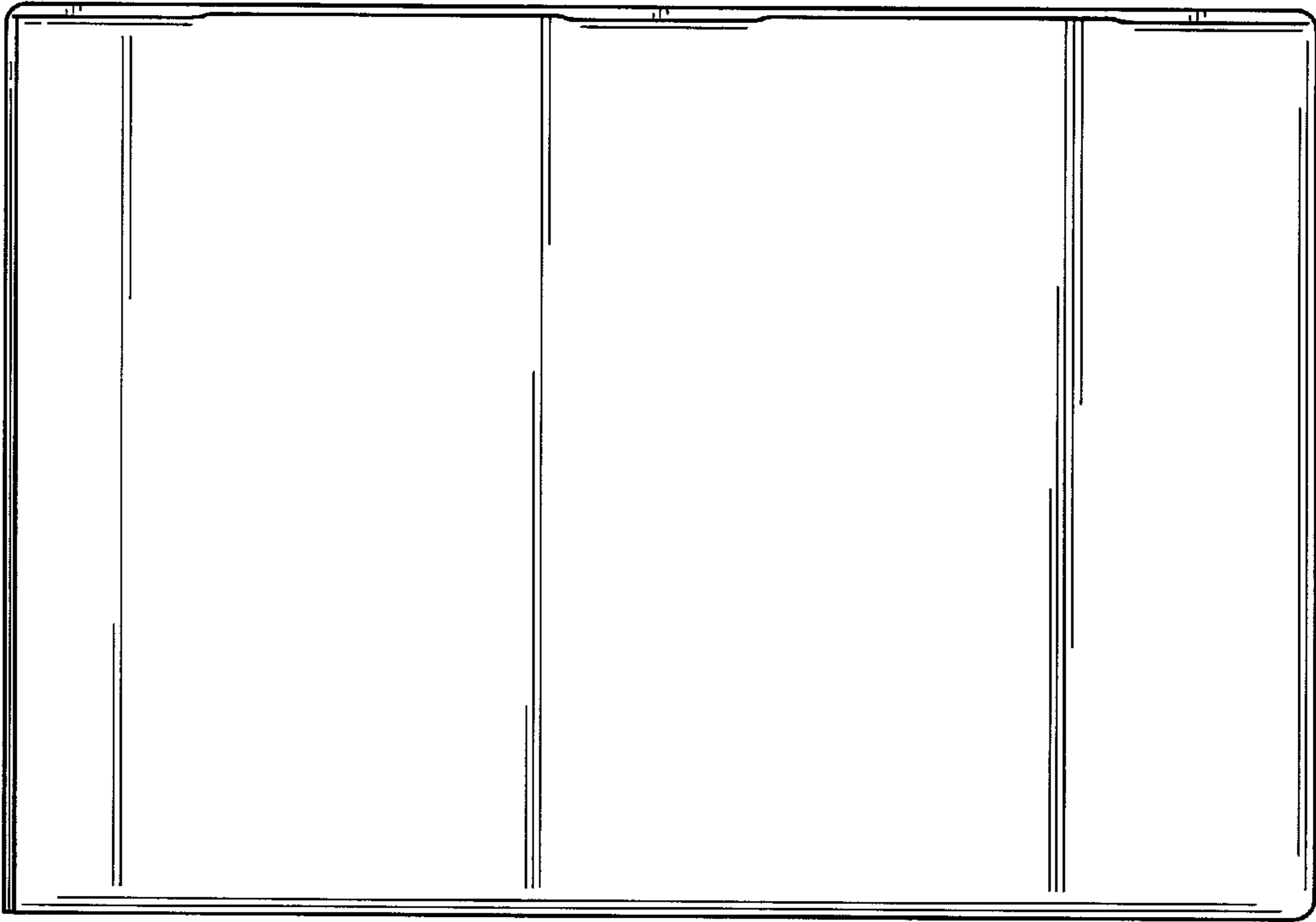

FIG. 6

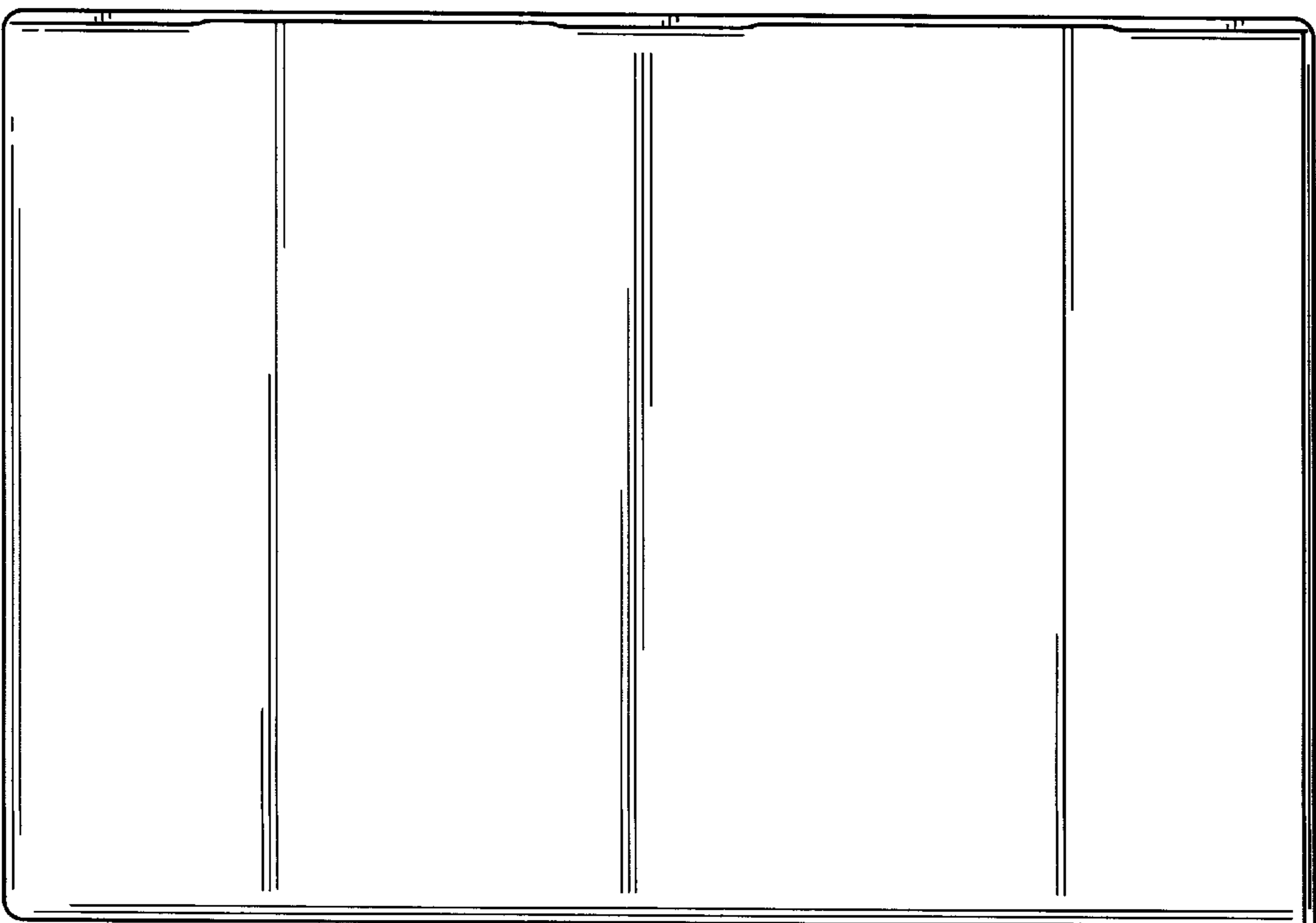

FIG. 7

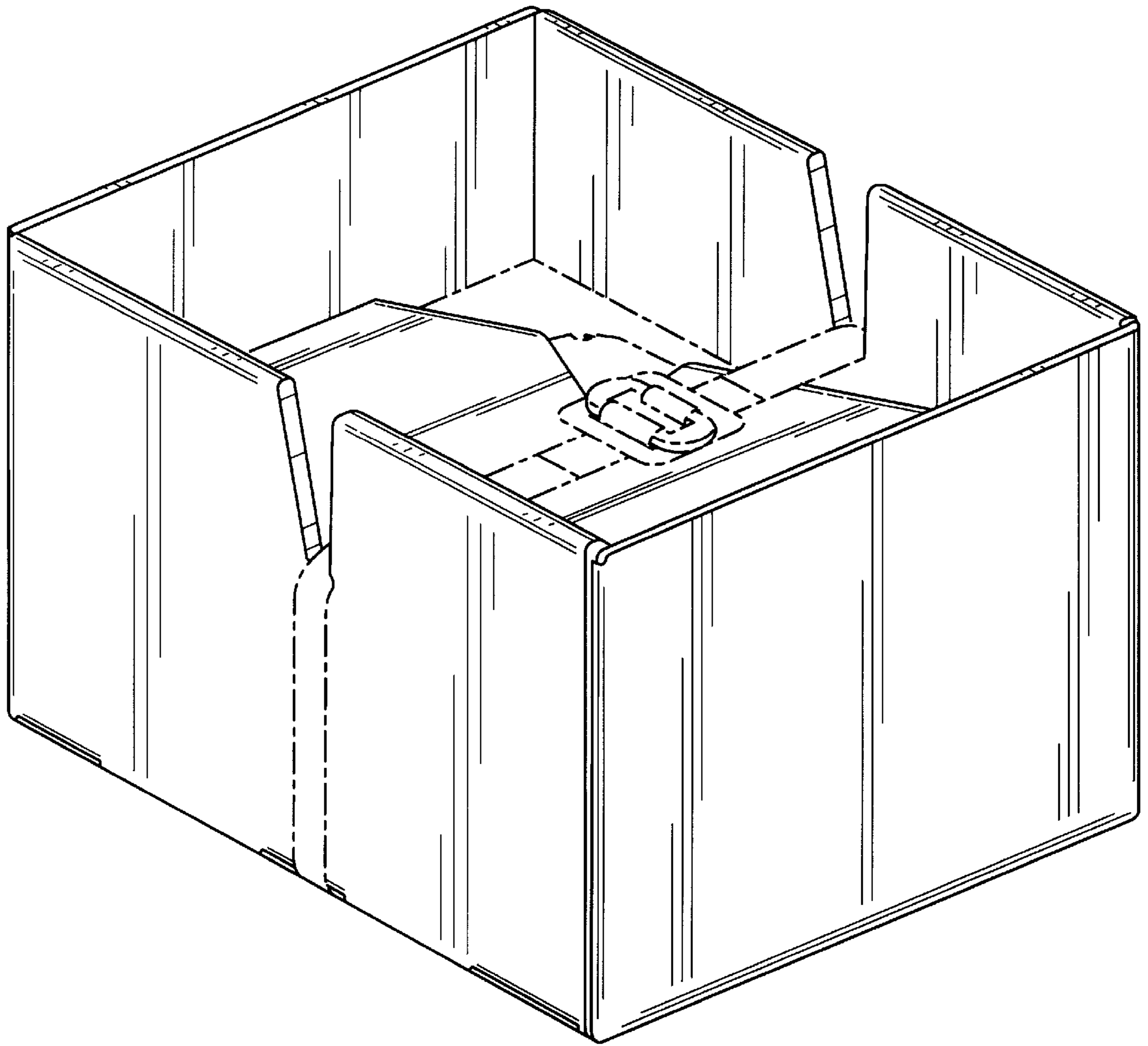

FIG. 8

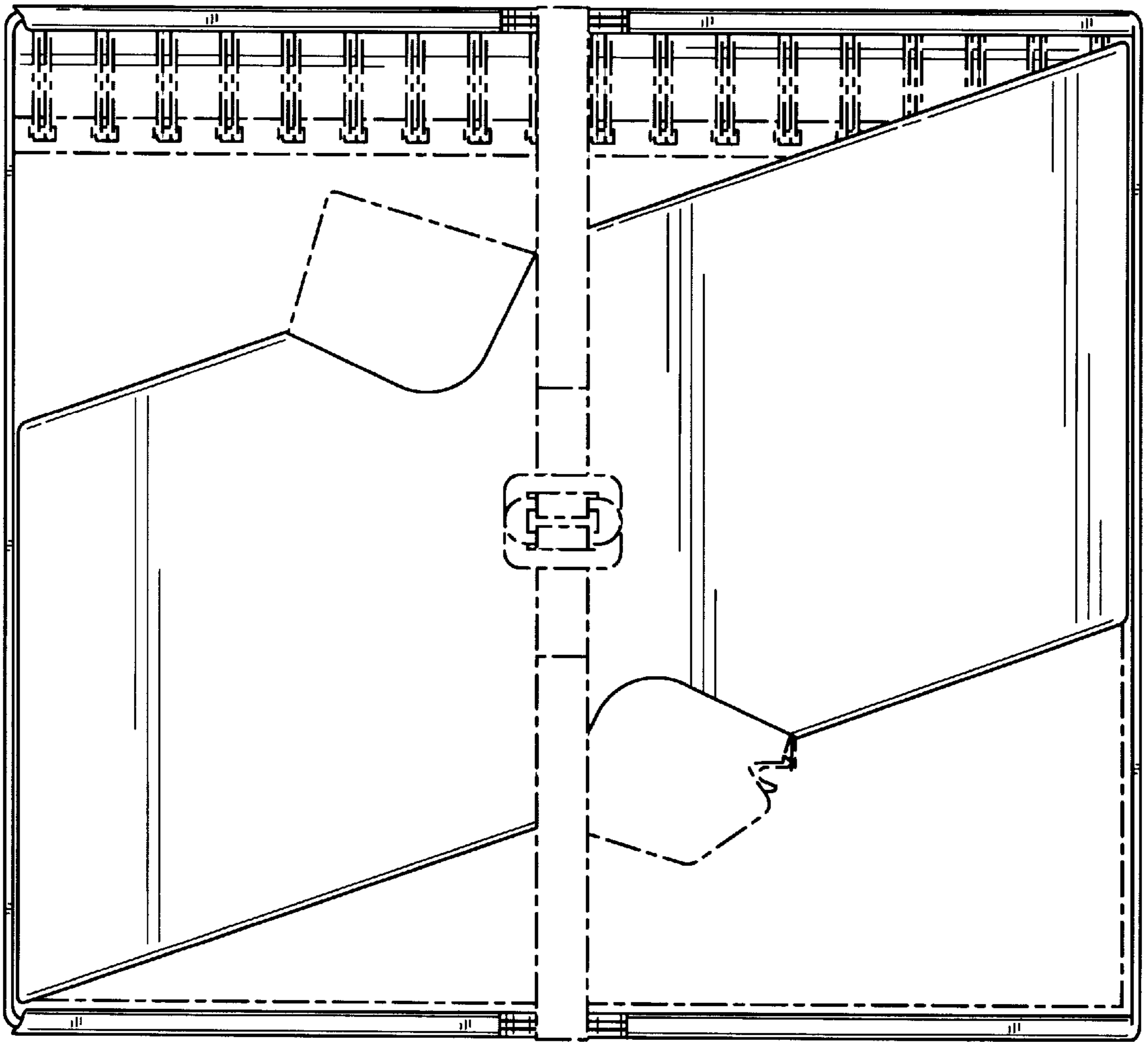

FIG. 9

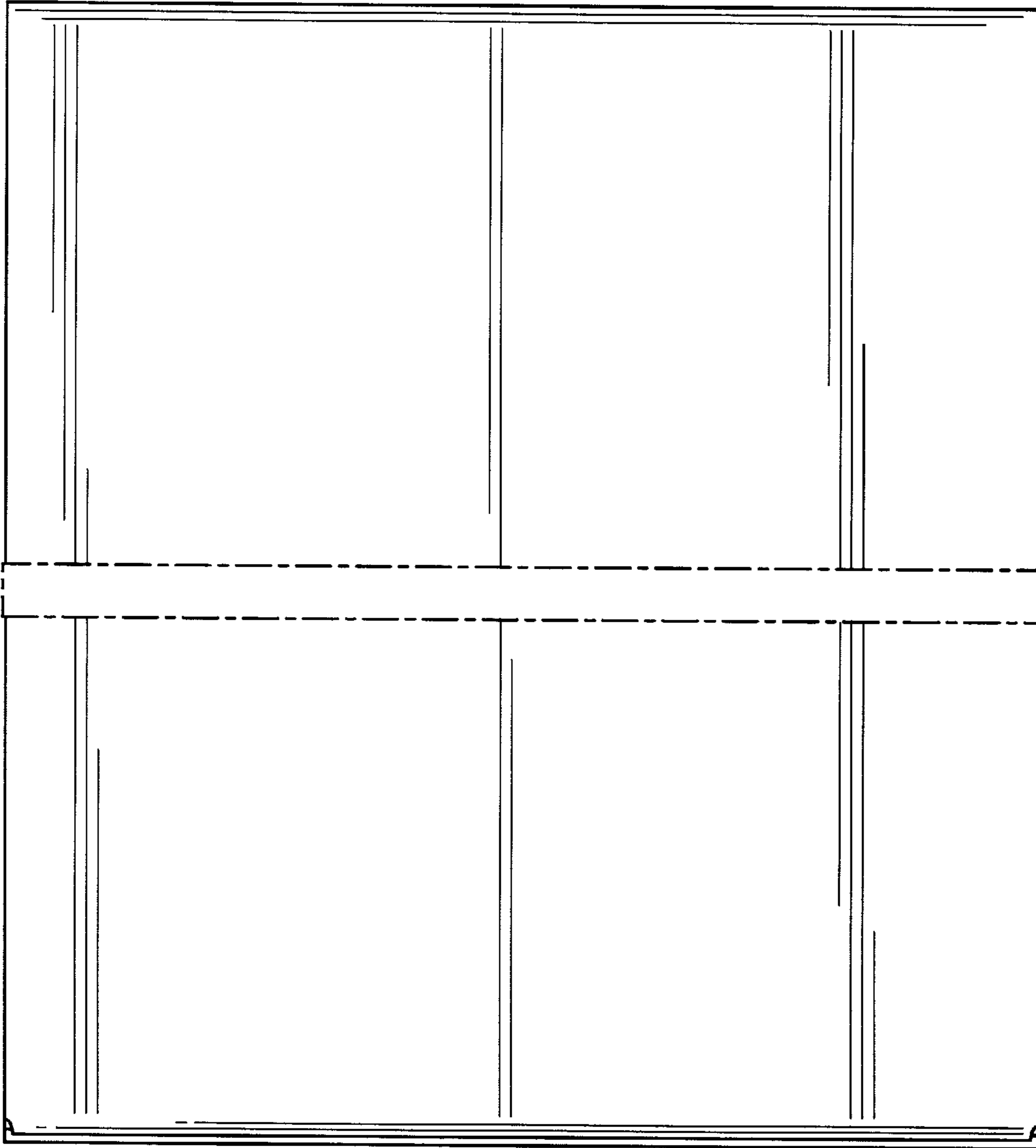

FIG. 10

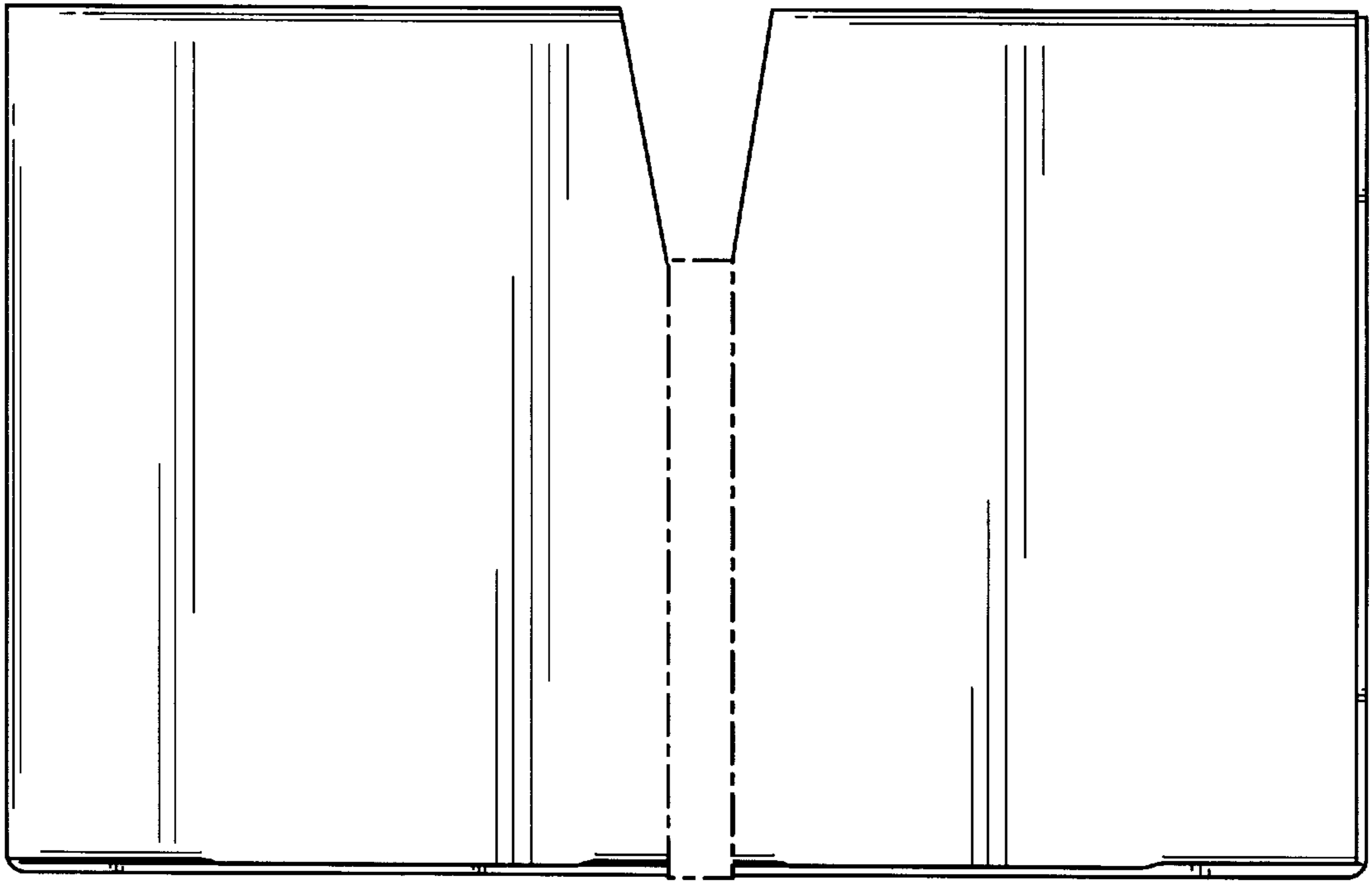

FIG. 11

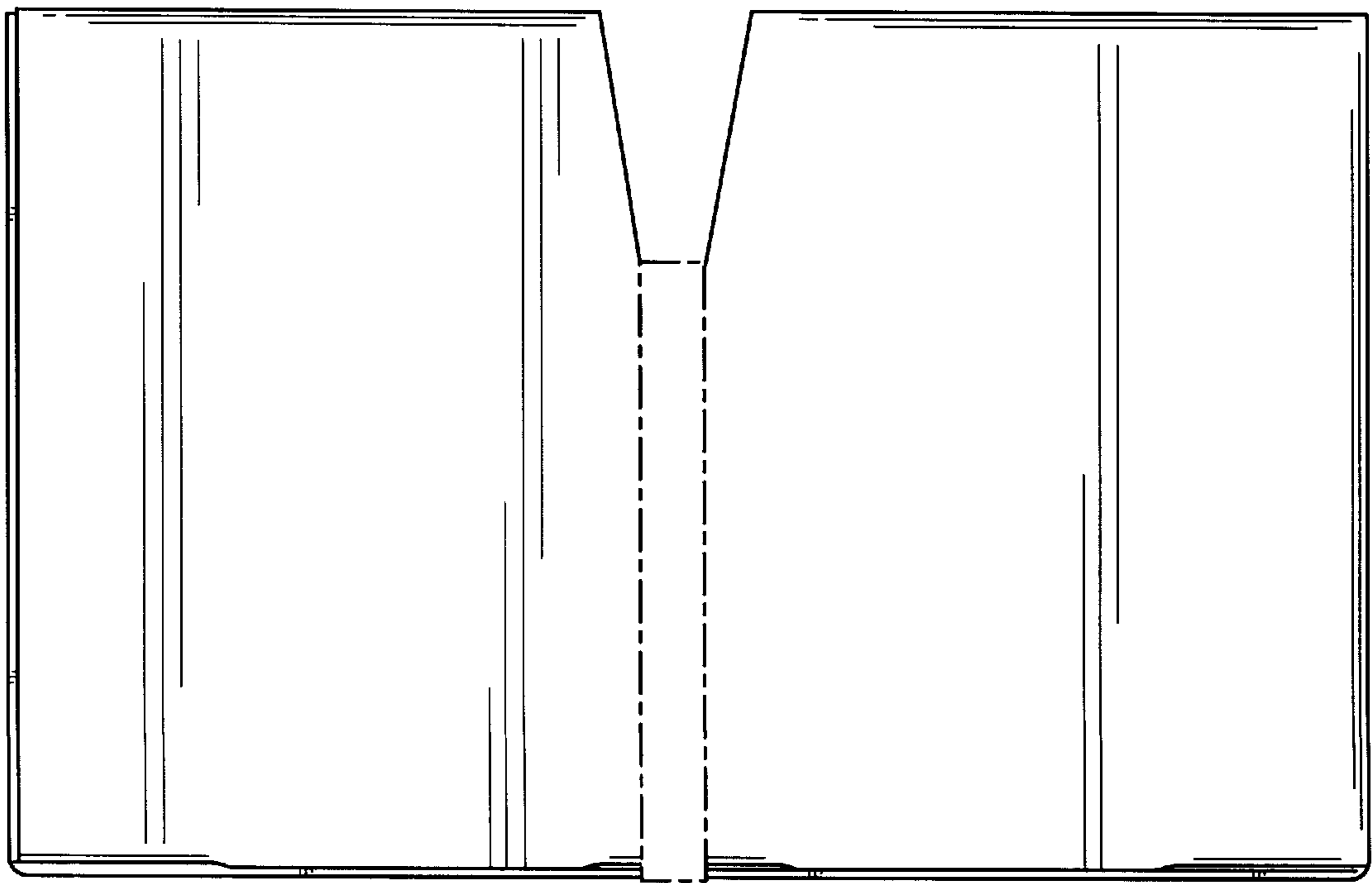

FIG. 12

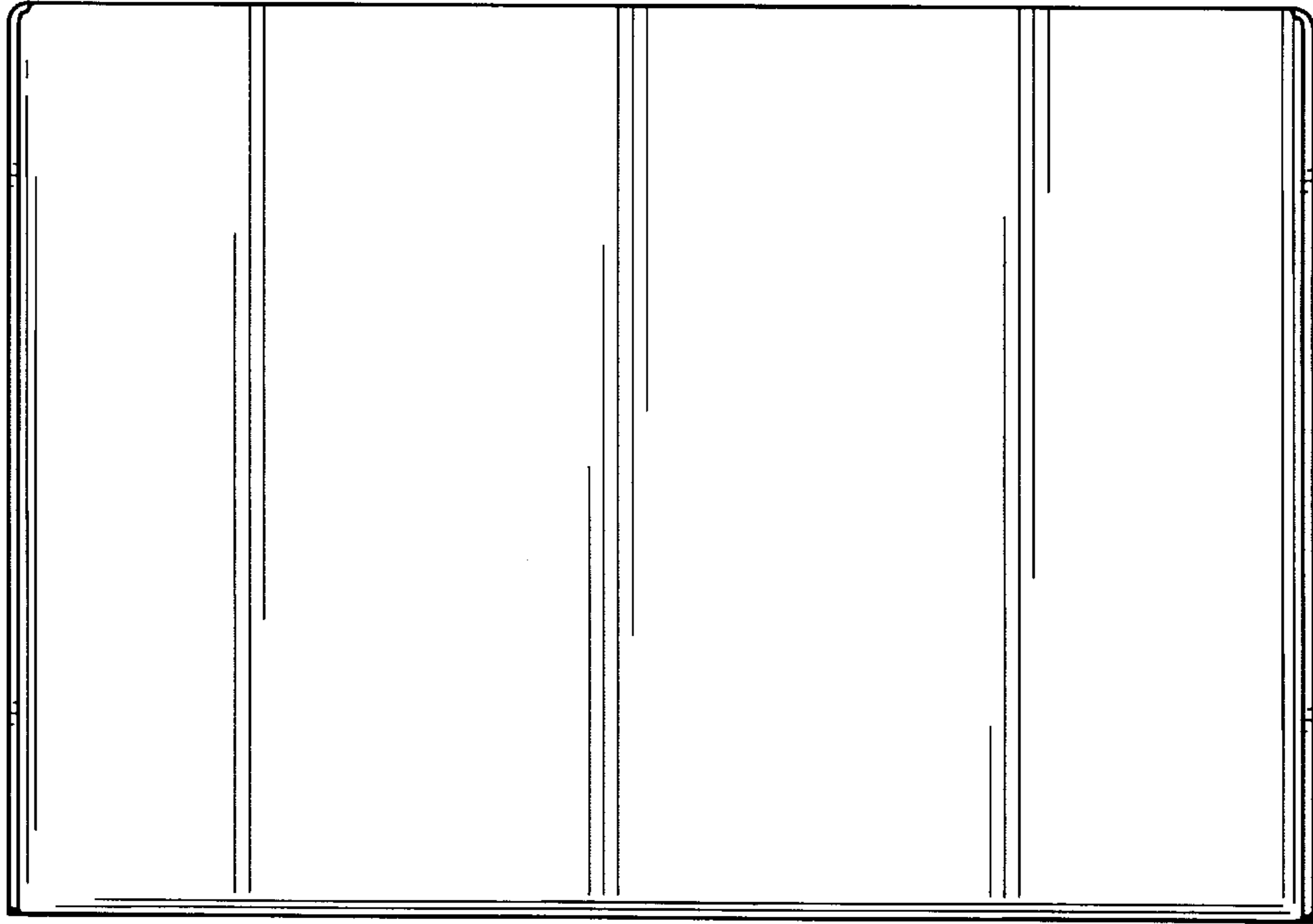

FIG. 13

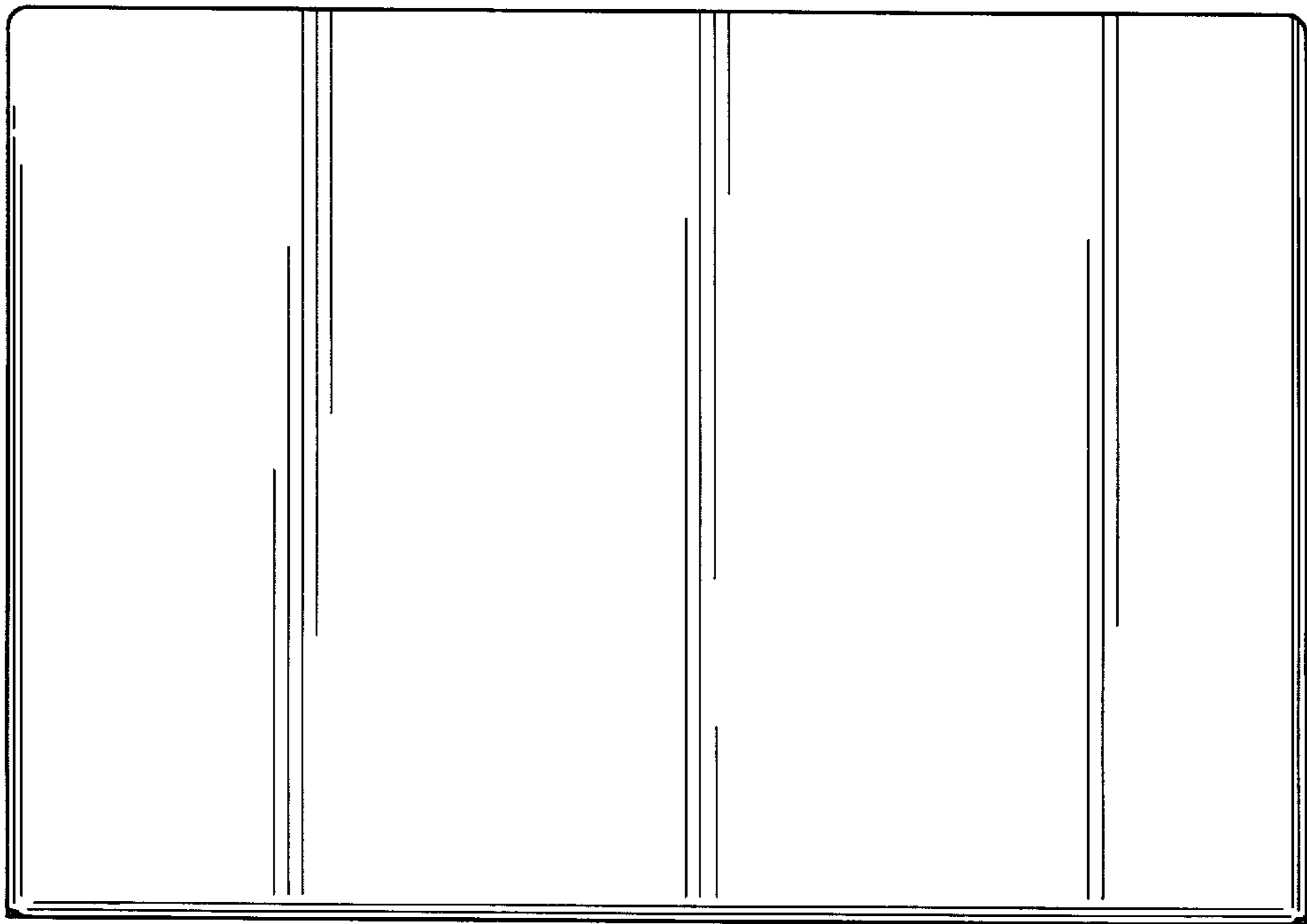

FIG. 14

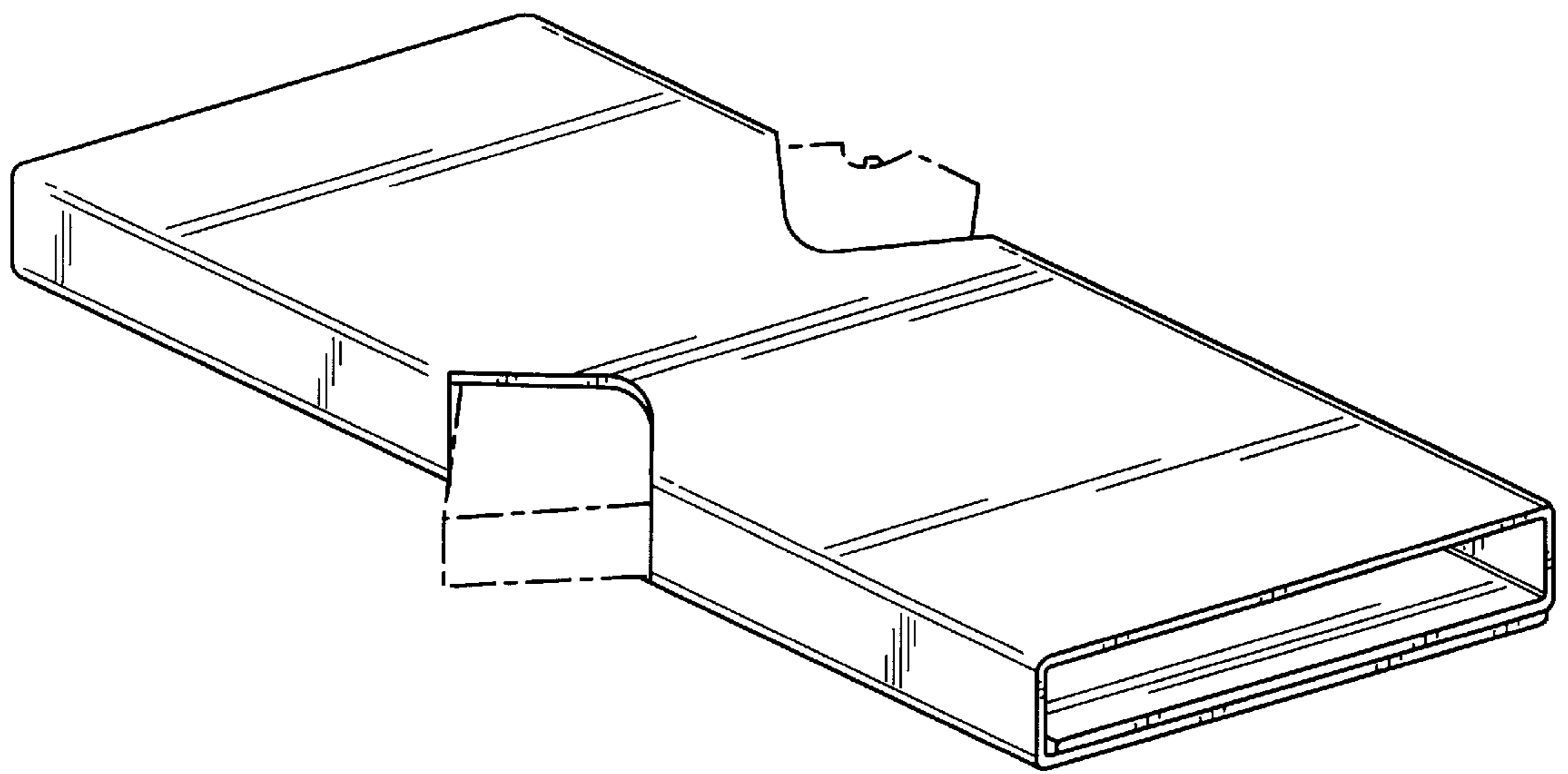

FIG. 15

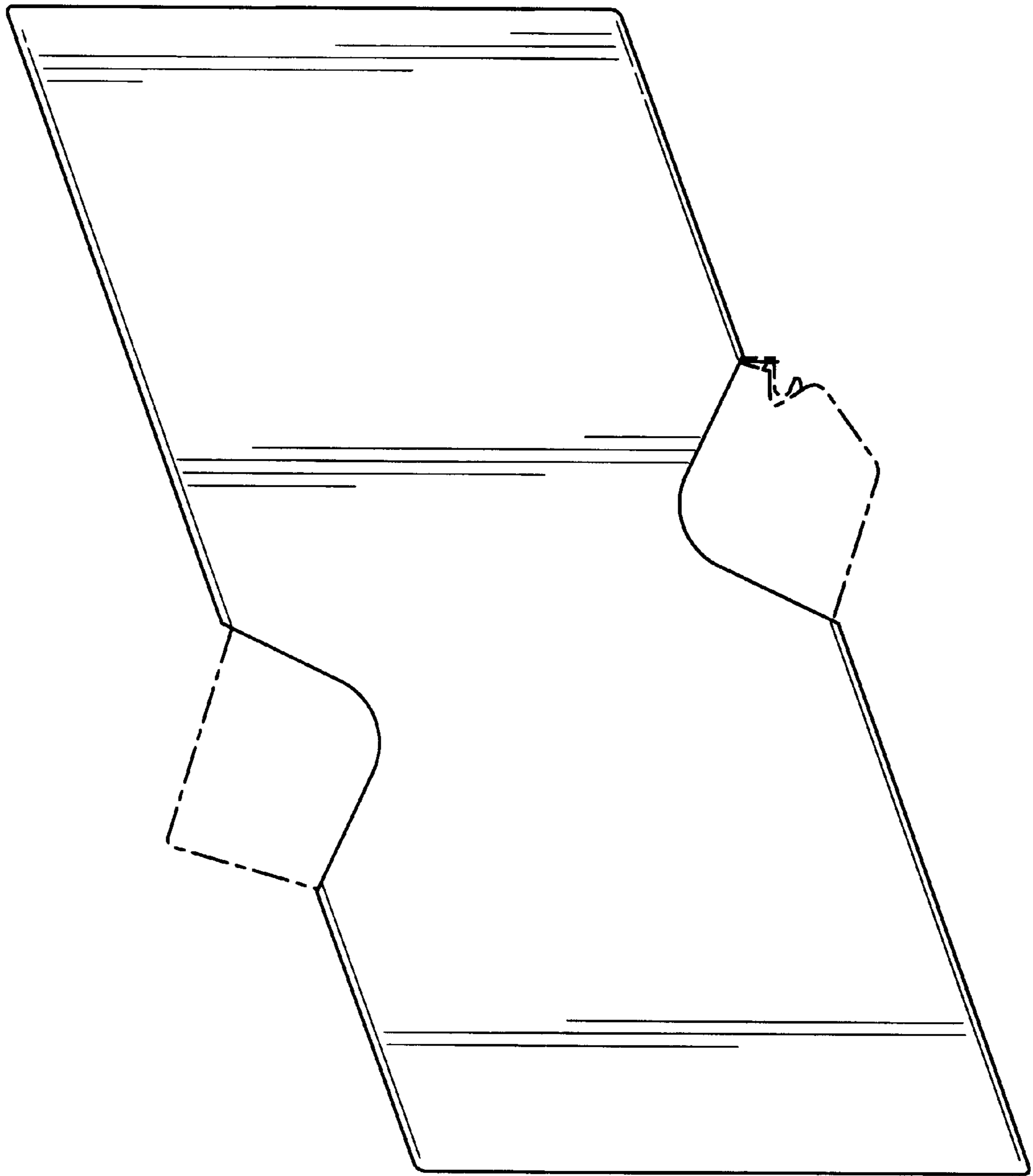

FIG. 16

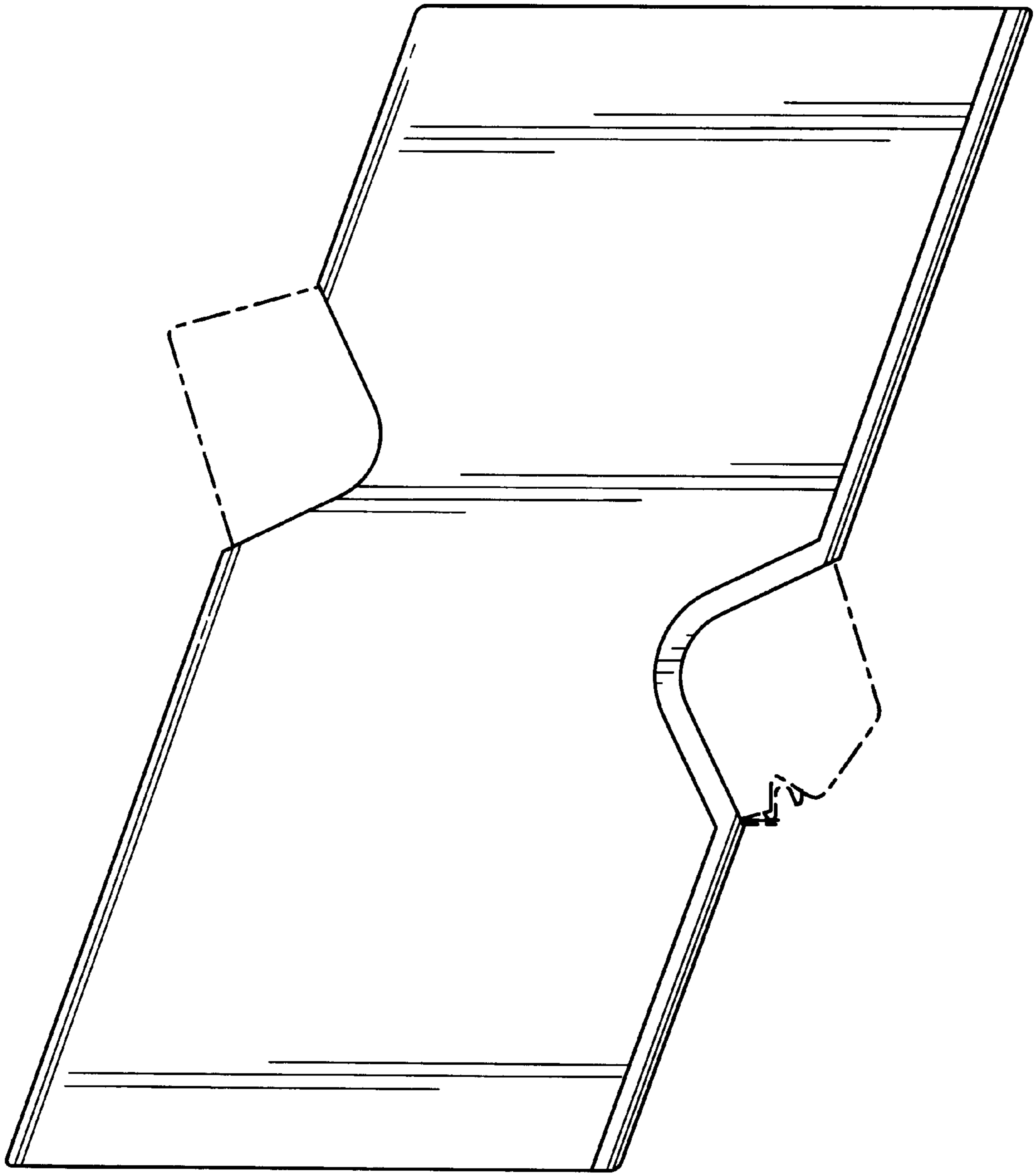

FIG. 17

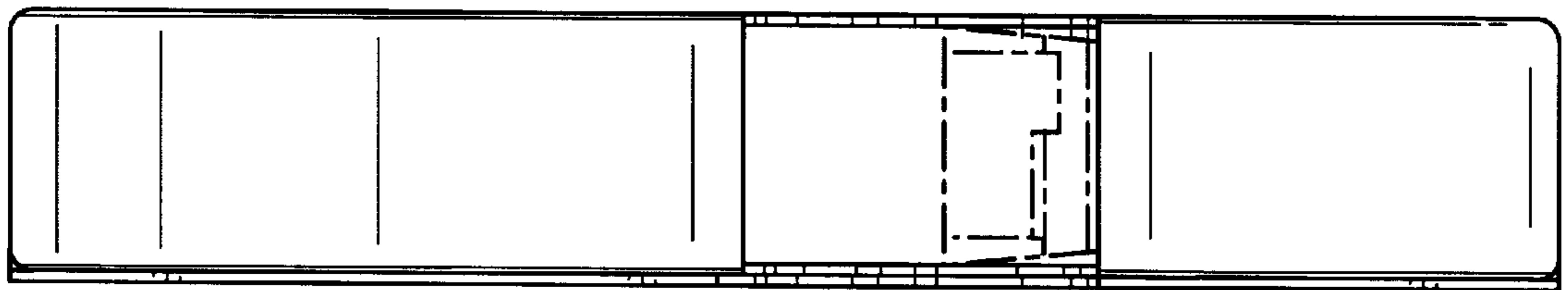

FIG. 18

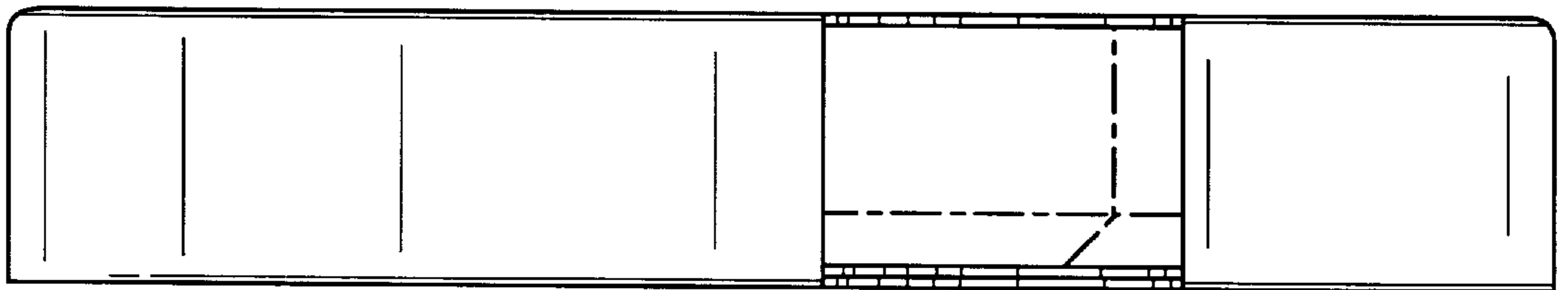

FIG. 19

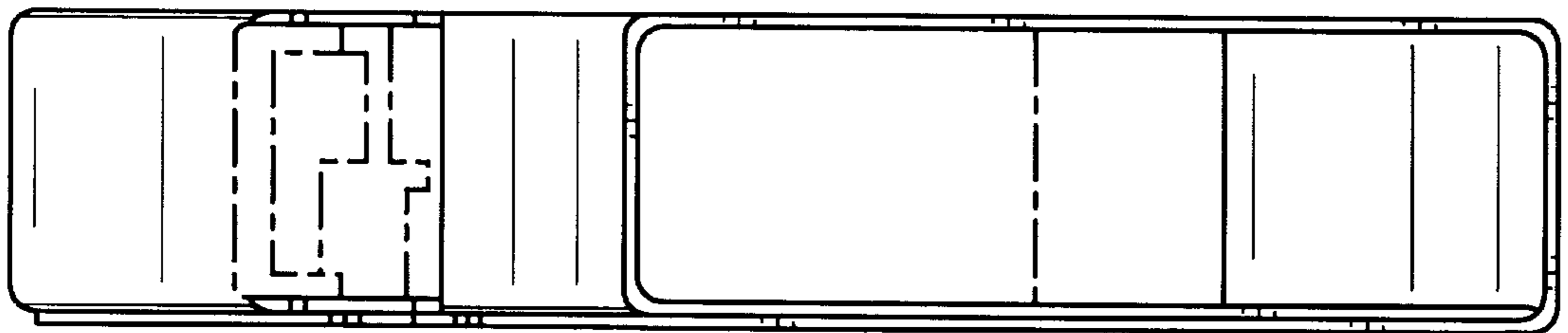

FIG. 20

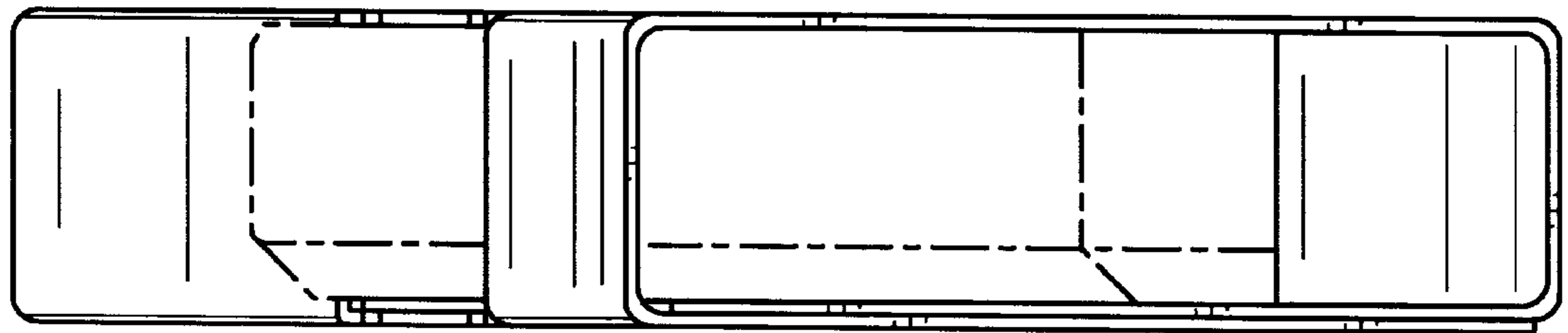

FIG. 21