



US00D458839S

(12) **United States Design Patent**
Weinstein et al.

(10) **Patent No.:** **US D458,839 S**
(45) **Date of Patent:** **** Jun. 18, 2002**

- (54) **HANDLESET PACKAGING**
- (75) Inventors: **Michael Weinstein; Eric E. Thompson**, both of Costa Mesa, CA (US)
- (73) Assignee: **Emhart Inc.**, Newark, DE (US)
- (**) Term: **14 Years**
- (21) Appl. No.: **29/125,904**
- (22) Filed: **Jun. 30, 2000**
- (51) **LOC (7) Cl.** **09-03**
- (52) **U.S. Cl.** **D9/415; D9/418**
- (58) **Field of Search** D9/414, 415, 418, D9/337, 345; 206/461-471, 495, 806, 207, 234, 320, 349, 372; D3/201, 905

- D394,384 S 5/1998 Humphrey
- 5,816,411 A 10/1998 Smith
- D405,370 S 2/1999 Humphrey
- D406,056 S 2/1999 Flores et al.
- D406,528 S 3/1999 Flores et al.
- 5,890,593 A 4/1999 Humphrey
- D414,108 S 9/1999 Humphrey
- 5,975,294 A * 11/1999 Hsi-Chang 206/349
- 6,016,914 A * 1/2000 Gustafson 206/470
- D420,905 S * 2/2000 Adkins D9/415
- D430,017 S * 8/2000 Ito et al. D9/415

* cited by examiner

Primary Examiner—Prabhakar Deshmukh
(74) *Attorney, Agent, or Firm*—Harness, Dickey & Pierce P.L.C.

(57) **CLAIM**

The ornamental design of a handset packaging, as shown and described.

DESCRIPTION

FIG. 1 is a perspective view of a handset packaging in accordance with the present invention.
 FIG. 2 is a top plan view of the present invention shown in FIG. 1.
 FIG. 3 is a front elevational view of the present invention shown in FIG. 1.
 FIG. 4 is a bottom plan view of the present invention shown in FIG. 1.
 FIG. 5 is a right side elevational view of the present invention shown in FIG. 1.
 FIG. 6 is a left side elevational view of the present invention shown in FIG. 1; and,
 FIG. 7 is a rear elevational view of the present invention shown in FIG. 1.

1 Claim, 7 Drawing Sheets

- (56) **References Cited**
- U.S. PATENT DOCUMENTS**
- 4,307,803 A 12/1981 Johnson
 - 4,359,182 A 11/1982 Perkins, Jr.
 - D272,805 S * 2/1984 Johnsen D9/415
 - 4,702,368 A * 10/1987 Jones 206/461
 - D299,114 S 12/1988 Klinge
 - 4,993,623 A 2/1991 Kelly et al.
 - D315,095 S 3/1991 Wright
 - D315,302 S 3/1991 Kistler
 - D320,469 S 10/1991 Hoenig
 - 5,064,056 A 11/1991 Gresh
 - D328,248 S 7/1992 Ruff
 - 5,129,516 A 7/1992 Theros
 - 5,188,222 A 2/1993 Pierce
 - 5,435,447 A 7/1995 Weatherford et al.
 - D367,226 S 2/1996 Ransbottom
 - 5,622,258 A 4/1997 Baublitz et al.
 - 5,718,335 A 2/1998 Bourdreaux

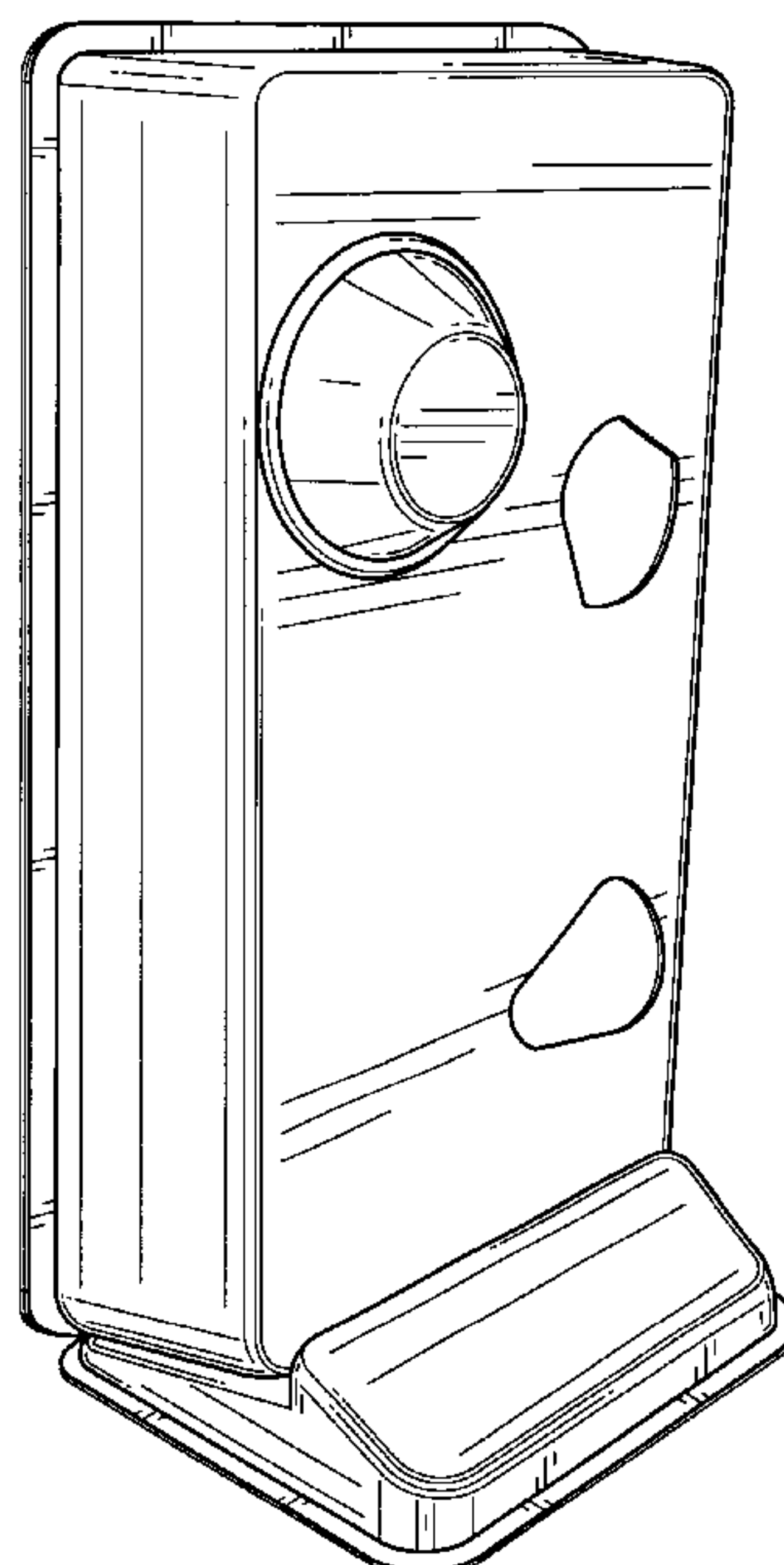

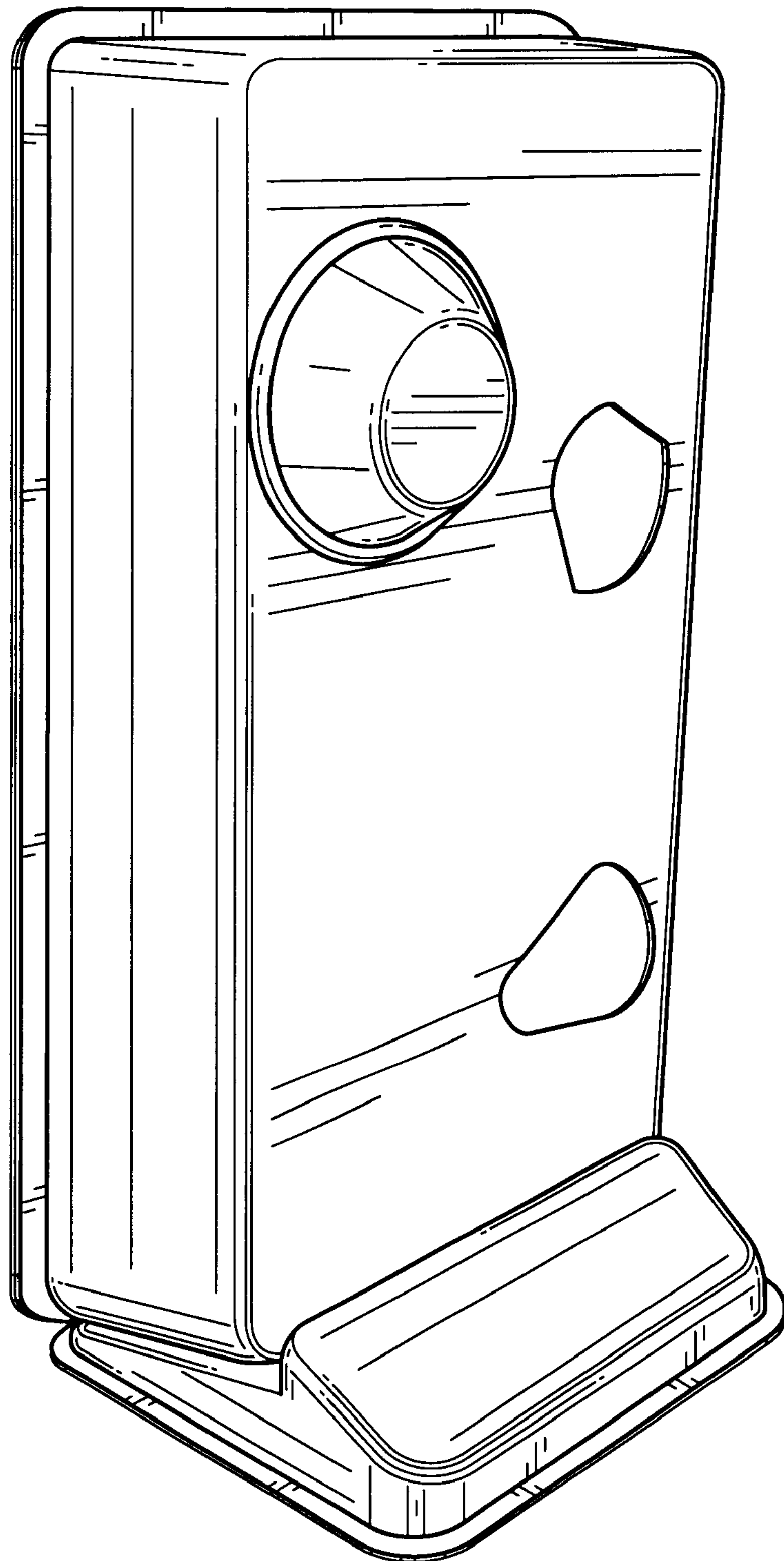

FIG. 1

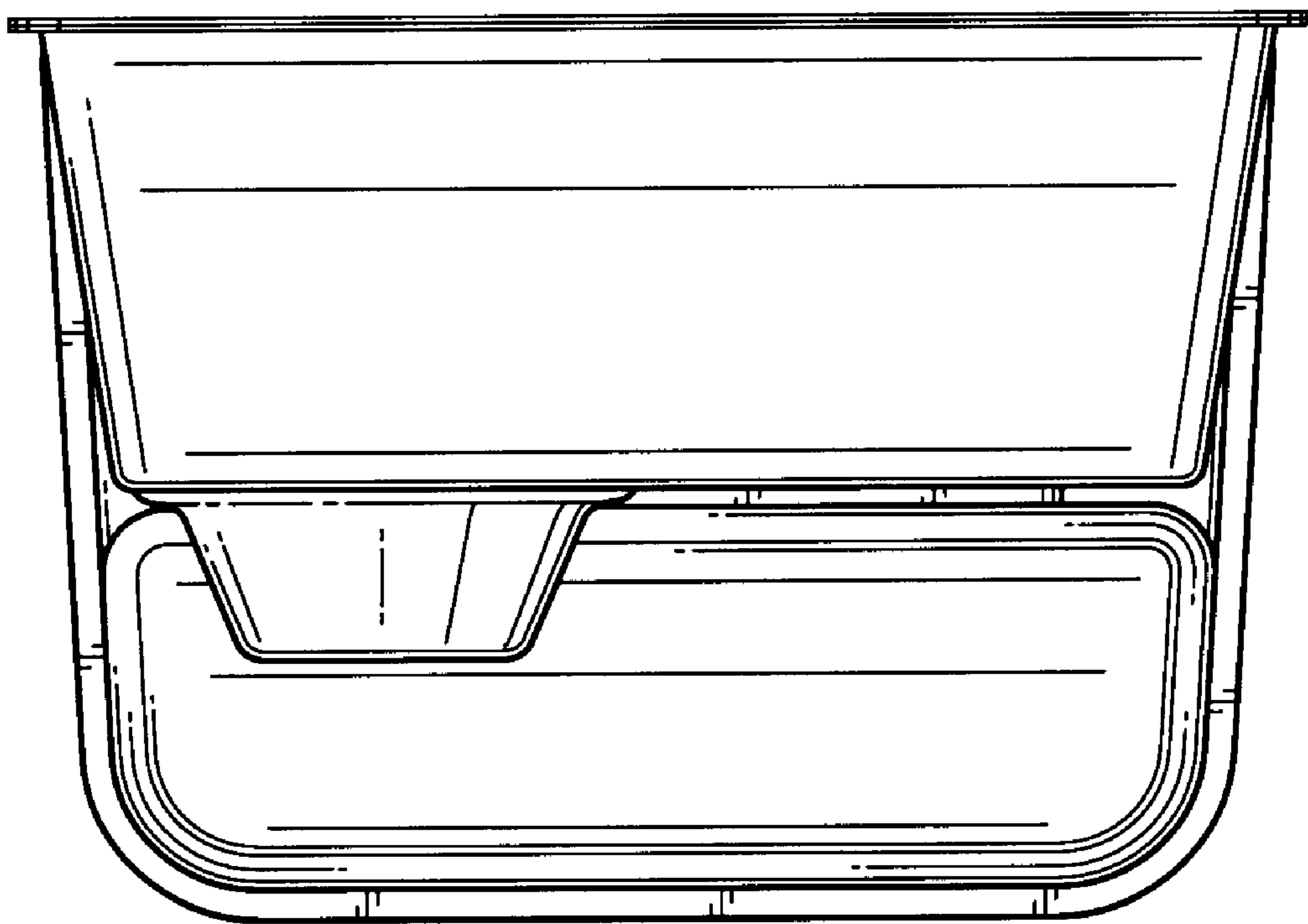

FIG. 2

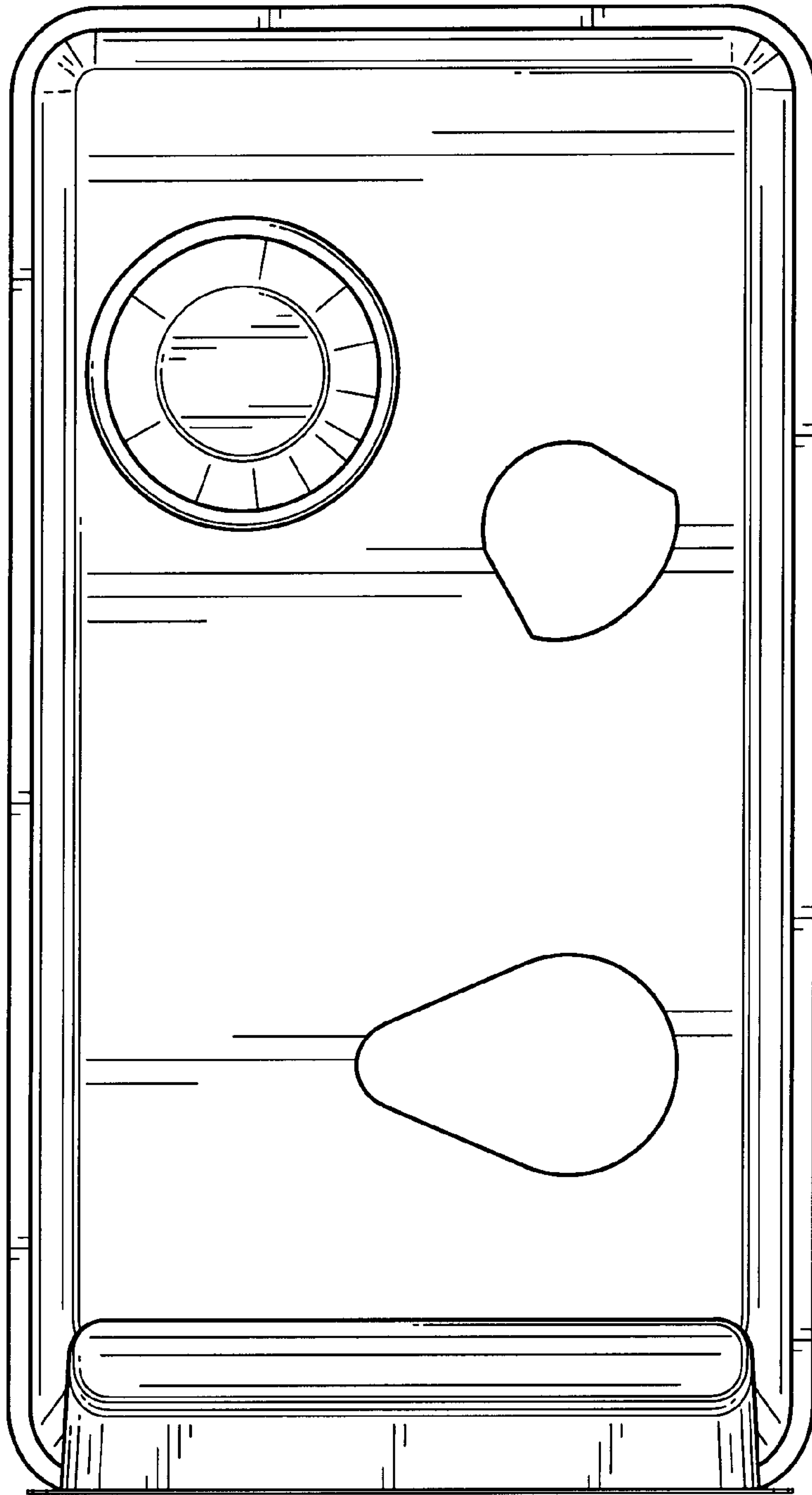

FIG. 3

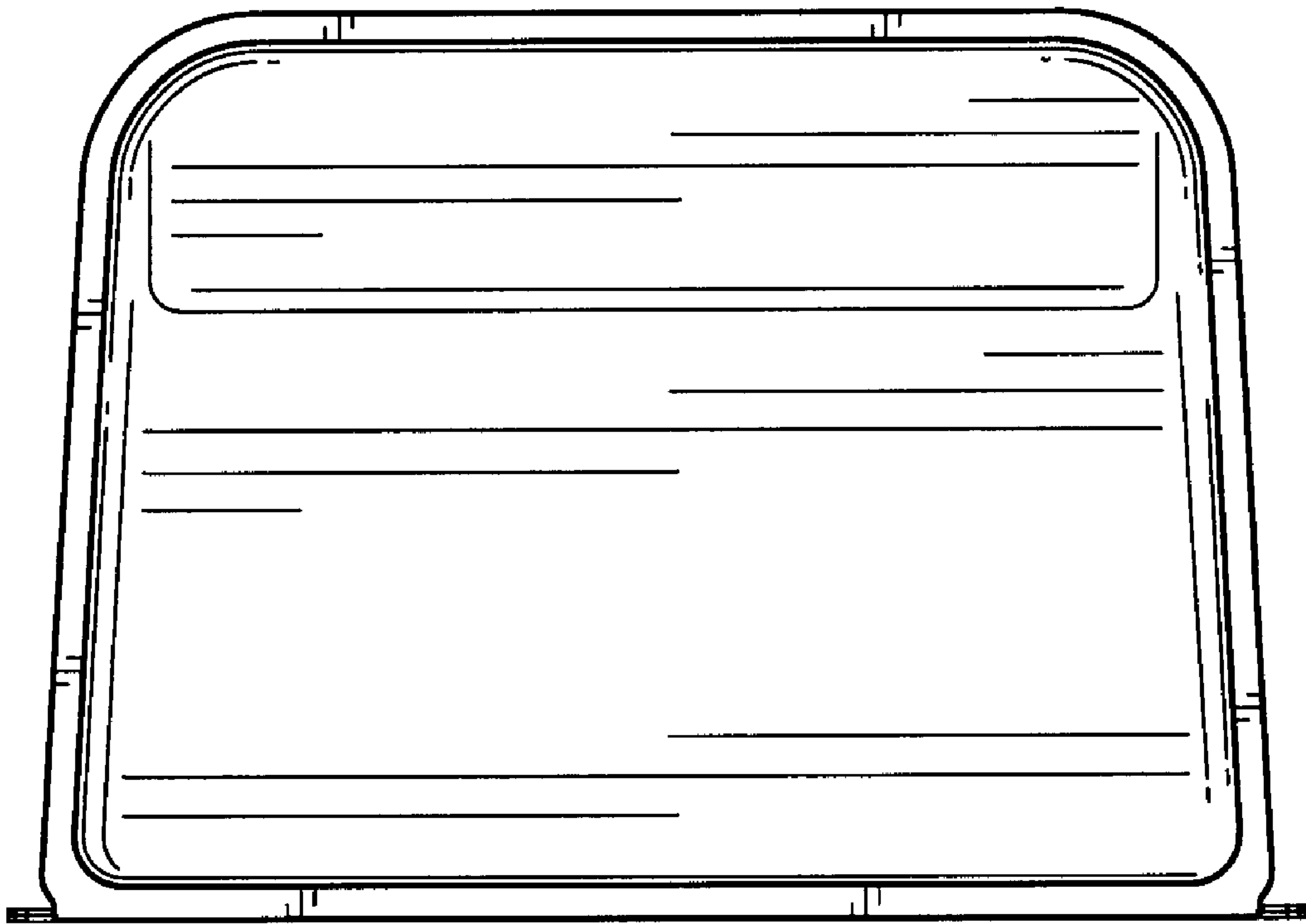

FIG. 4

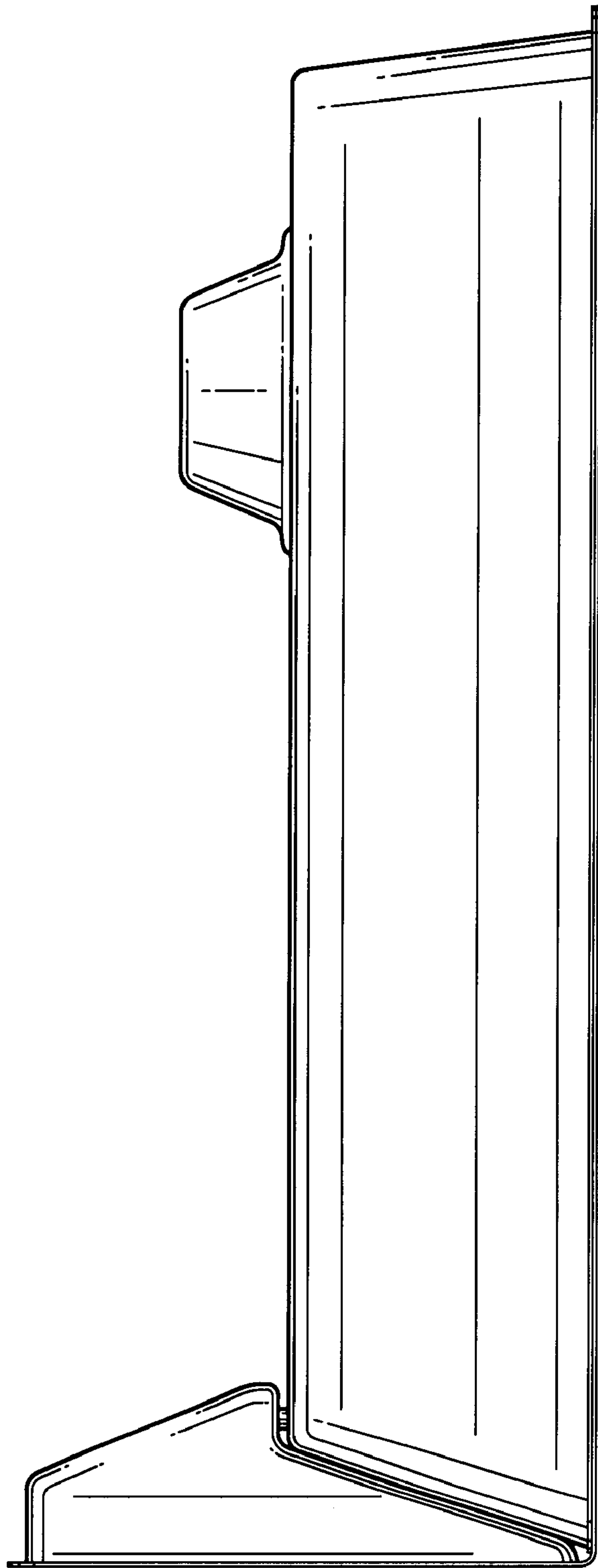

FIG. 5

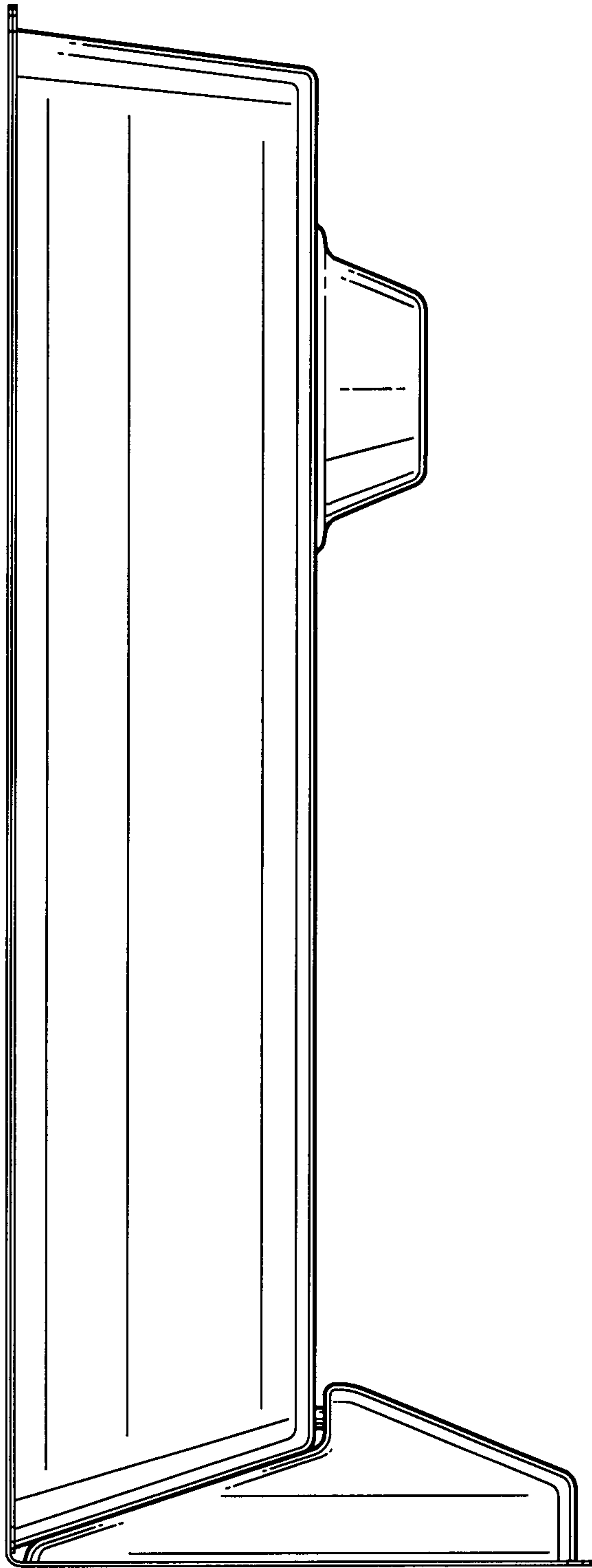

FIG. 6

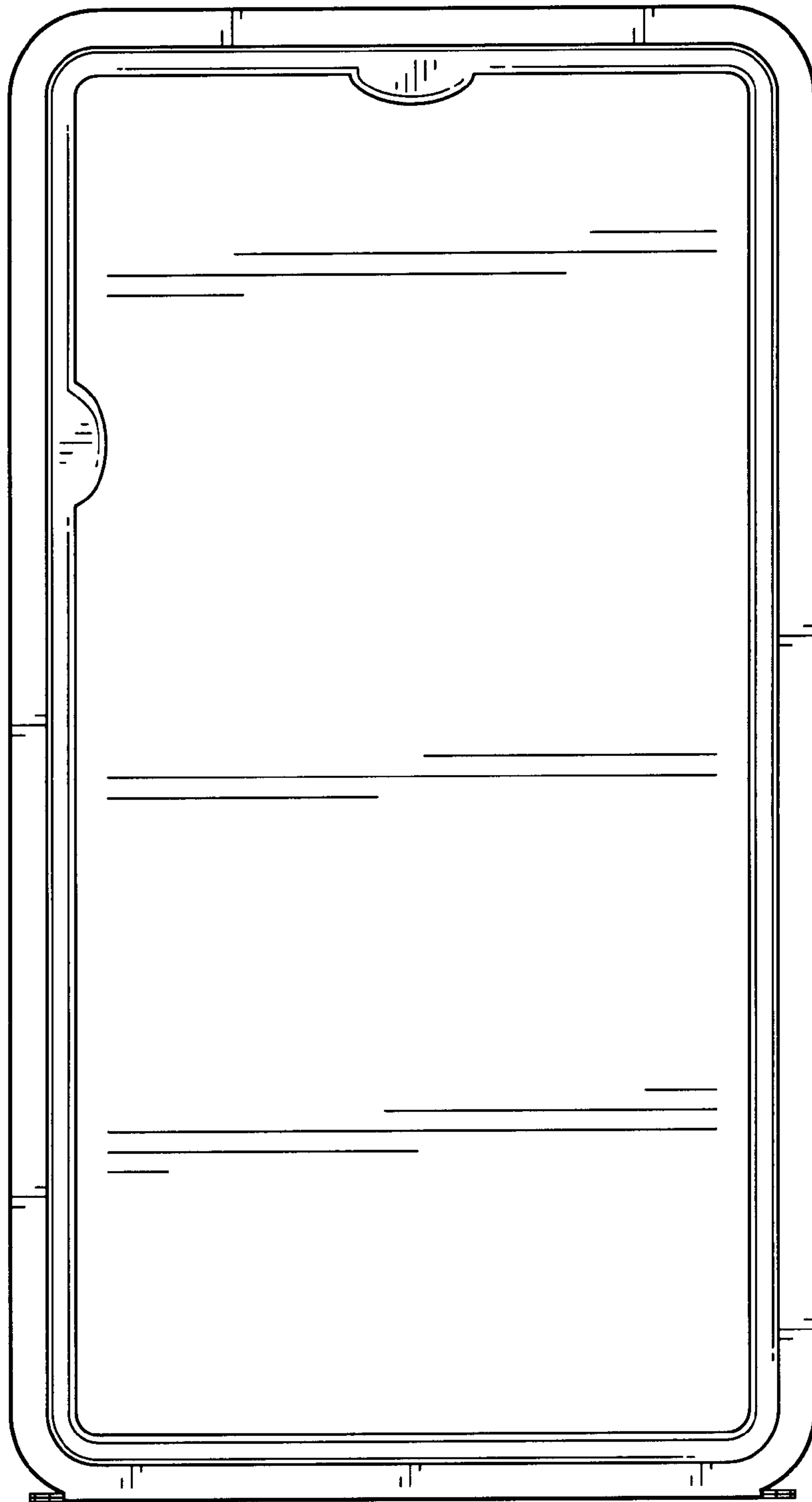

FIG. 7