



US00D458758S

(12) **United States Design Patent**  
**Nanda**

(10) **Patent No.:** **US D458,758 S**  
(45) **Date of Patent:** **\*\* Jun. 18, 2002**

(54) **COMBINATION HANDLE AND REVERSIBLE TOOTHBRUSH SHAFT**

(75) Inventor: **Puneet Nanda**, Cerritos, CA (US)

(73) Assignee: **Dr. Fresh, Inc.**, La Mirada, CA (US)

(\*\*) Term: **14 Years**

(21) Appl. No.: **29/150,410**

(22) Filed: **Nov. 13, 2001**

(51) **LOC (7) Cl.** ..... **04-02**

(52) **U.S. Cl.** ..... **D4/104**

(58) **Field of Search** ..... D4/104-112, 132-134, D4/138; 15/143.1, 159.1, 160, 167.1, 186, 187; 132/308; 601/139, 141

(56) **References Cited**

**U.S. PATENT DOCUMENTS**

90,235 A *	5/1869	Burrows	.....	15/167.1
2,512,935 A *	6/1950	Hansen	.....	15/167.1
D308,765 S *	6/1990	Johnson	.....	D4/104
5,144,712 A *	9/1992	Hansel et al.	.....	15/167.1

\* cited by examiner

*Primary Examiner*—Lisa Lichtenstein

(74) *Attorney, Agent, or Firm*—The Soni Law Firm; Andrew S. Naglestad

(57) **CLAIM**

The ornamental design for a combination handle and reversible toothbrush shaft, as shown and described.

**DESCRIPTION**

FIG. 1 is a top front perspective view of my ornamental combination handle and reversible toothbrush shaft, the

reversible toothbrush shaft being inserted into the handle such that the base of the reversible toothbrush shaft extends beyond the right end of the of the handle;

FIG. 2 is a front side elevation of the combination handle and reversible toothbrush shaft as illustrated in FIG. 1;

FIG. 3 is a top view of the combination handle and reversible toothbrush shaft as illustrated in FIG. 1;

FIG. 4 is a bottom view of the combination handle and reversible toothbrush shaft as illustrated in FIG. 1;

FIG. 5 is a left end elevation of the combination handle and reversible toothbrush shaft as illustrated in FIG. 1;

FIG. 6 is a right end elevation of the combination handle and reversible toothbrush shaft as illustrated in FIG. 1;

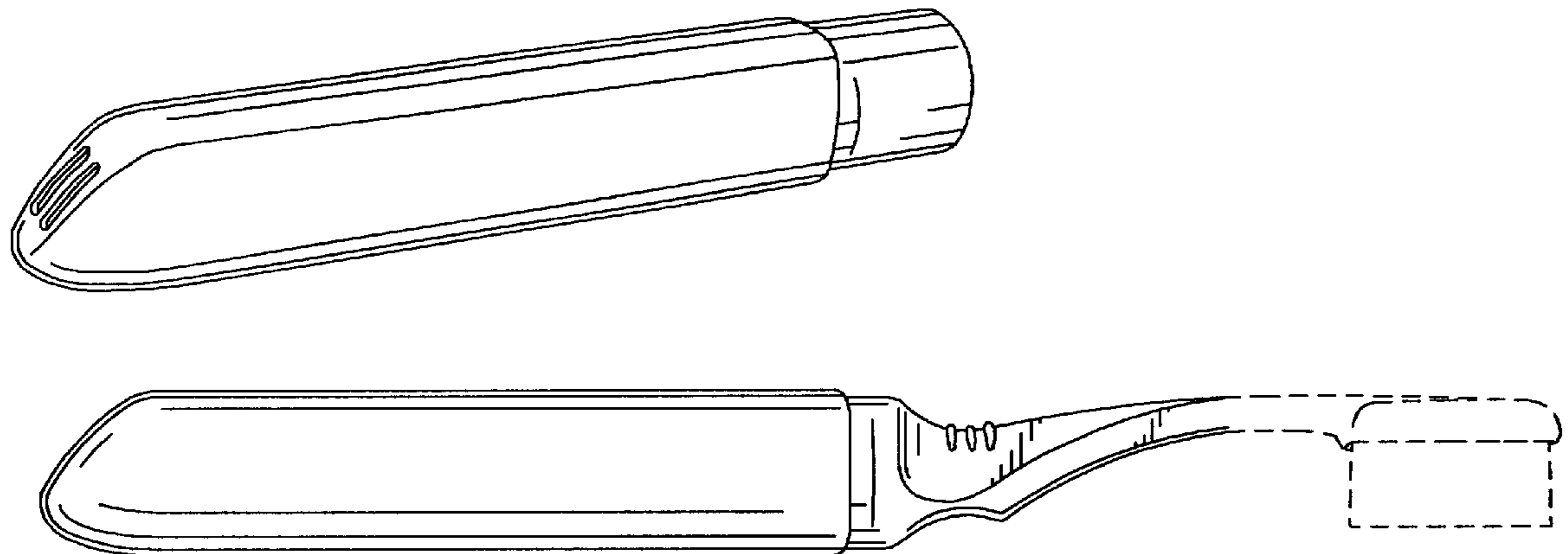
FIG. 7 is a front side elevation of the combination handle and reversible toothbrush shaft, the base of the reversible toothbrush shaft being inserted into the handle such that the bristle head extends beyond the right end of the of the handle;

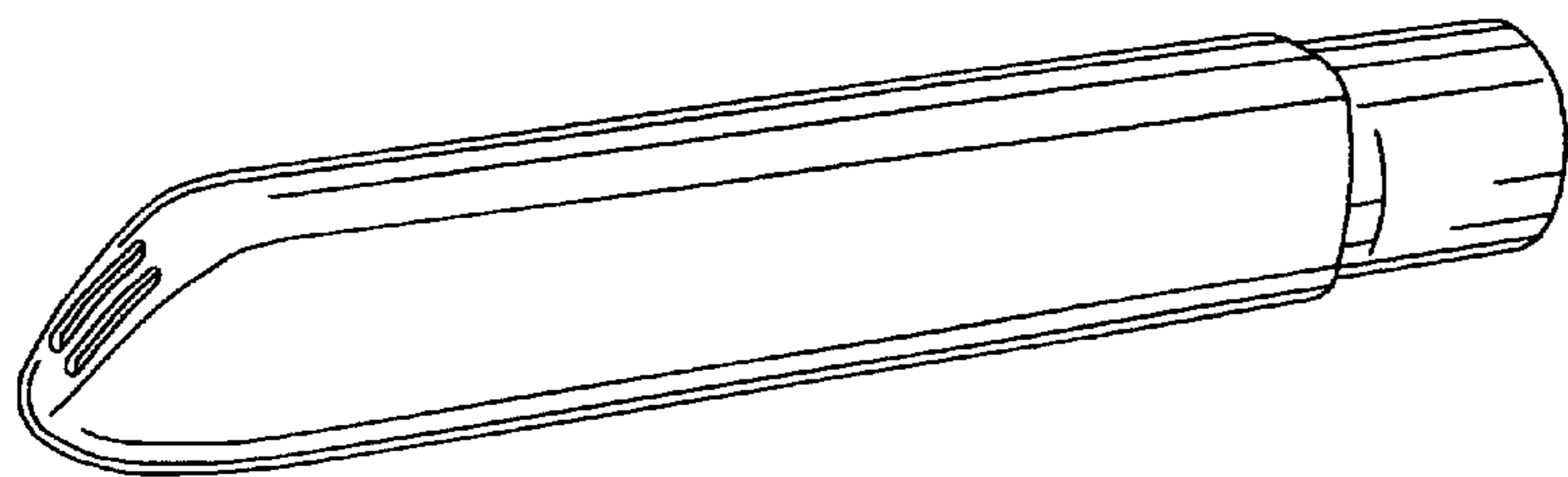
FIG. 8 is a top view of the combination handle and reversible toothbrush shaft as illustrated in FIG. 8; and,

FIG. 9 is a bottom view of the combination handle and reversible toothbrush shaft as illustrated in FIG. 8.

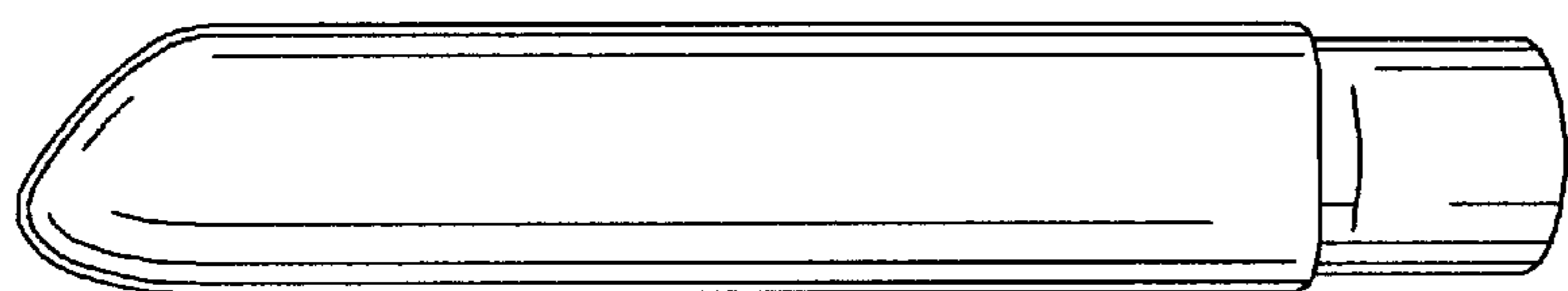
The broken lines representing the bristles and corresponding bristle head of the reversible toothbrush shaft in FIGS. 7 through 9 are for illustrative purposes and form no part of the claimed design. The backside elevation of the combination handle and reversible toothbrush shaft shown in FIG. 1 is opposite from and a mirror image of the front side elevation of FIG. 2. The backside elevation of the combination handle and reversible toothbrush shaft shown in FIG. 7 is opposite from and a mirror image of the front side elevation of FIG. 7.

**1 Claim, 2 Drawing Sheets**

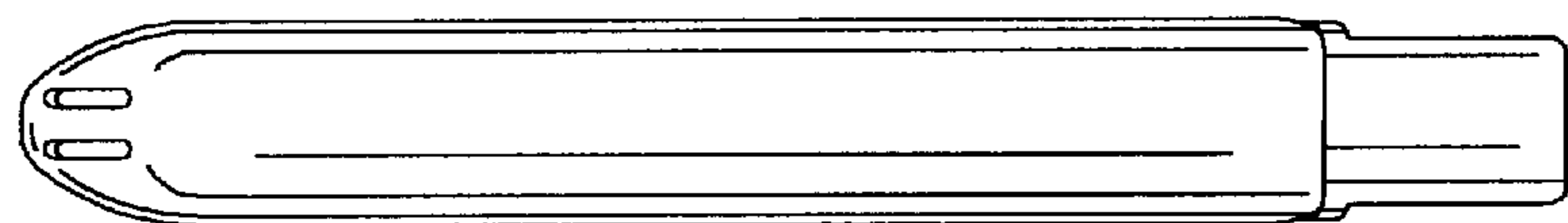




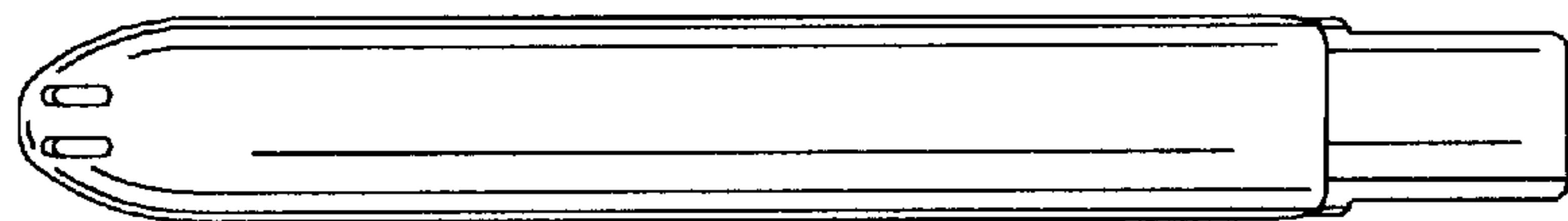
*FIG. 1*



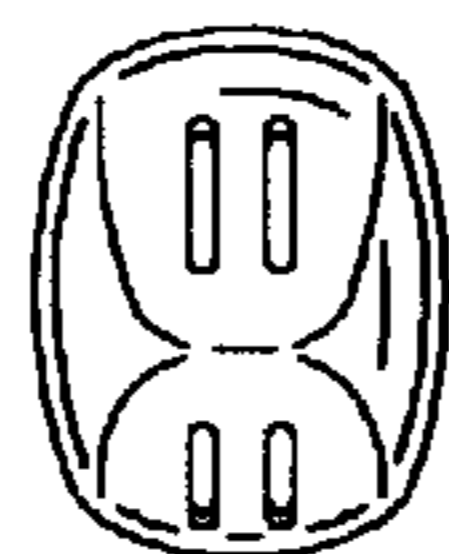
*FIG. 2*



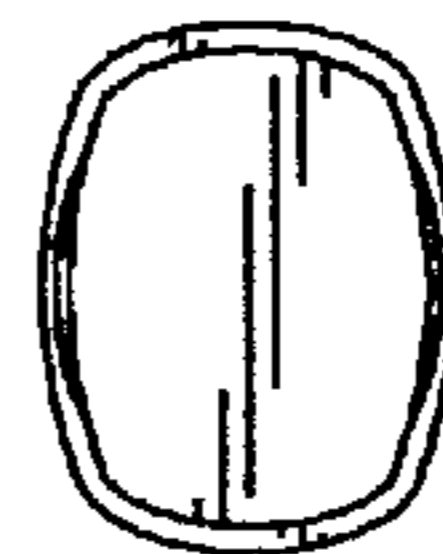
*FIG. 3*



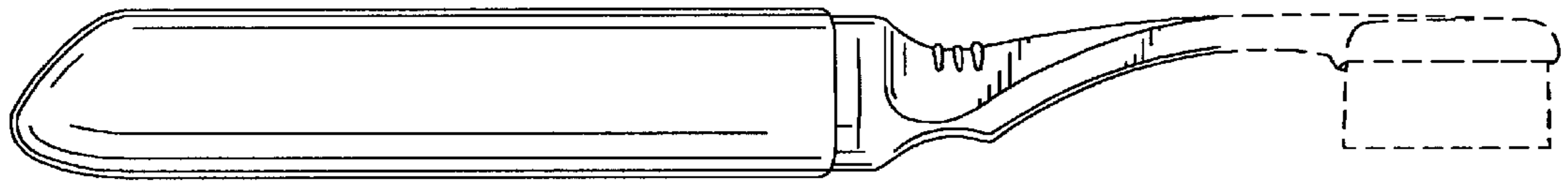
*FIG. 4*



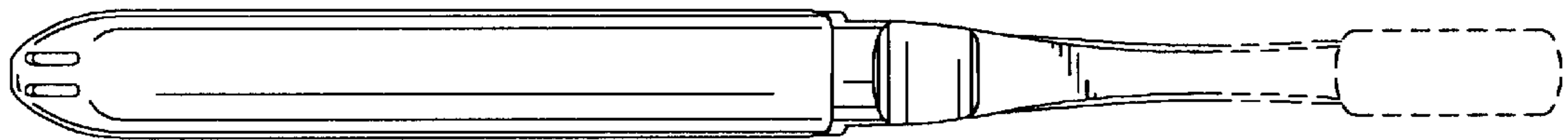
*FIG. 5*



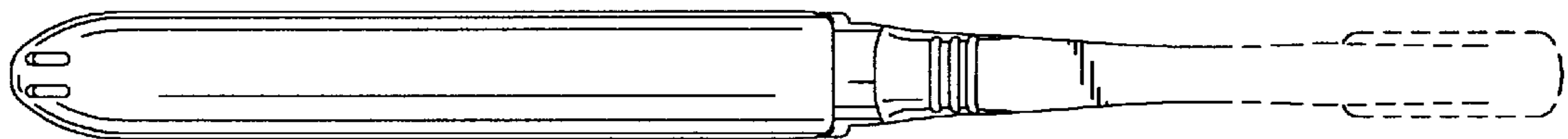
*FIG. 6*



*FIG. 7*



*FIG. 8*



*FIG. 9*