



US00D458747S

(12) **United States Design Patent**
Hields et al.

(10) **Patent No.:** **US D458,747 S**

(45) **Date of Patent:** **** Jun. 18, 2002**

(54) **FISHING ROD CASE**

(75) Inventors: **Paul W. R. Hields**, P.O. Box 502,
Avon, CO (US) 81620; **Mark Russell**
Henault, Arvada, CO (US)

(73) Assignee: **Paul W. R. Hields**, Avon, CO (US)

(**) Term: **14 Years**

(21) Appl. No.: **29/147,853**

(22) Filed: **Sep. 7, 2001**

(51) **LOC (7) Cl.** **03-01**

(52) **U.S. Cl.** **D3/260; D3/269**

(58) **Field of Search** D3/254, 255, 260,
D3/262, 269, 273, 294, 300; 206/315.11;
43/26

(56) **References Cited**

U.S. PATENT DOCUMENTS

3,349,512 A	10/1967	Walker	
3,811,216 A	5/1974	Sauvey et al.	43/26
4,171,588 A	10/1979	Hoffman et al.	43/26
D254,696 S	4/1980	Adams	D3/260
D316,327 S	4/1991	Craft	D3/260
5,046,279 A	9/1991	Smith et al.	43/26
D320,694 S	10/1991	Brant	D3/260

D321,281 S	11/1991	Cooper	D3/260
5,341,590 A	8/1994	Hepworth et al.	43/26
5,425,194 A	6/1995	Miller	43/26
D410,333 S	6/1999	Coca	D3/260
5,960,950 A	* 10/1999	Meeker et al.	206/315.11
6,062,382 A	* 5/2000	Czerkie	206/315.11
D453,622 S	* 2/2002	McClenahan et al.	D3/260

* cited by examiner

Primary Examiner—Philip S. Hyder

(74) *Attorney, Agent, or Firm*—Dorr, Carson, Sloan & Birney, P.C.

(57) **CLAIM**

The ornamental design for a fishing rod case, as shown and described.

DESCRIPTION

FIG. 1 is a top perspective view of a fishing rod case showing my new design.

FIG. 2 is a bottom perspective view thereof.

FIG. 3 is a top plan view thereof.

FIG. 4 is a right side elevational view thereof, with the left side elevational view being a mirror image of FIG. 4.

FIG. 5 is a bottom plan view thereof.

FIG. 6 is a rear elevational view thereof; and,

FIG. 7 is a front elevational view thereof.

1 Claim, 4 Drawing Sheets

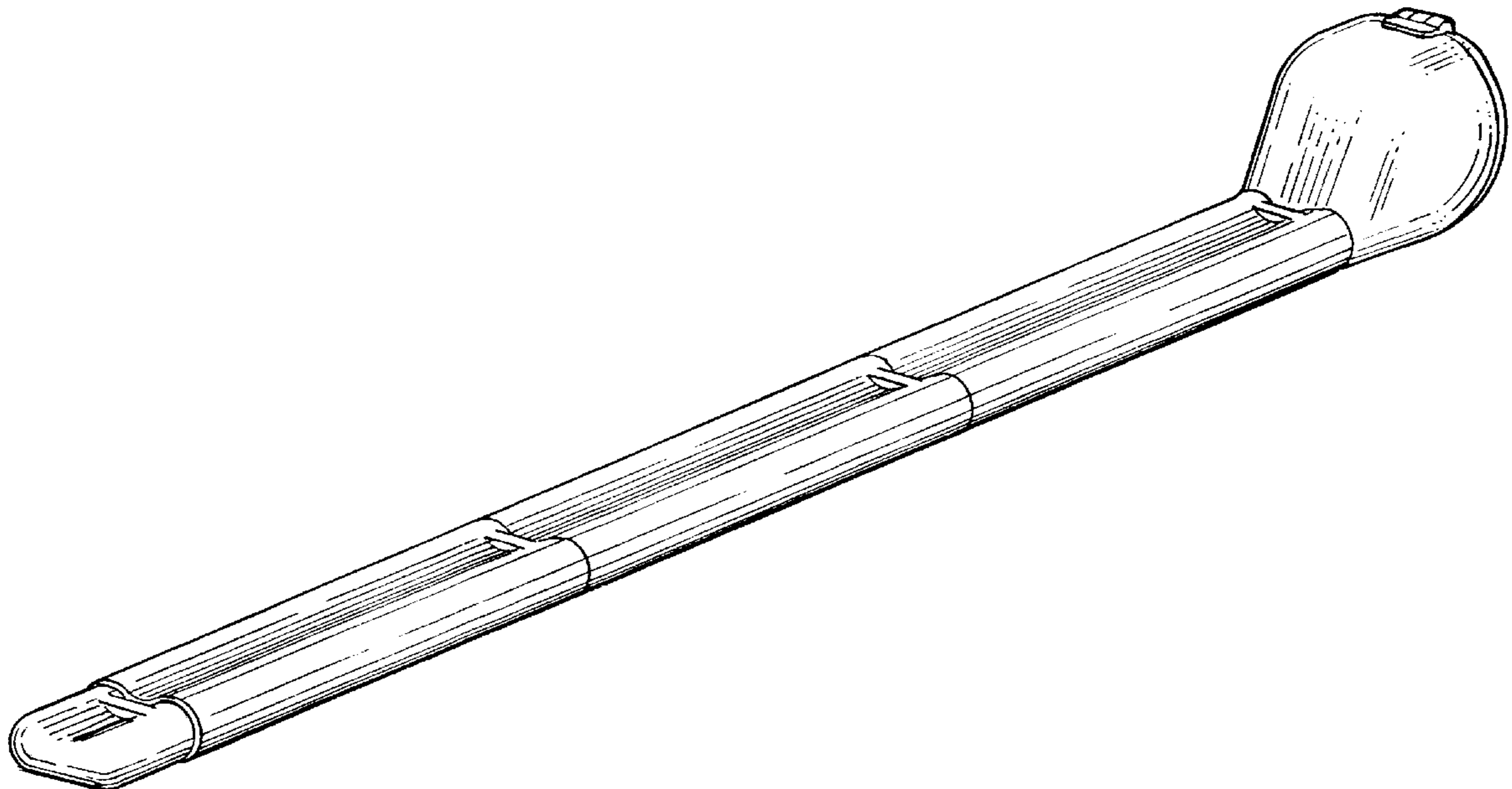

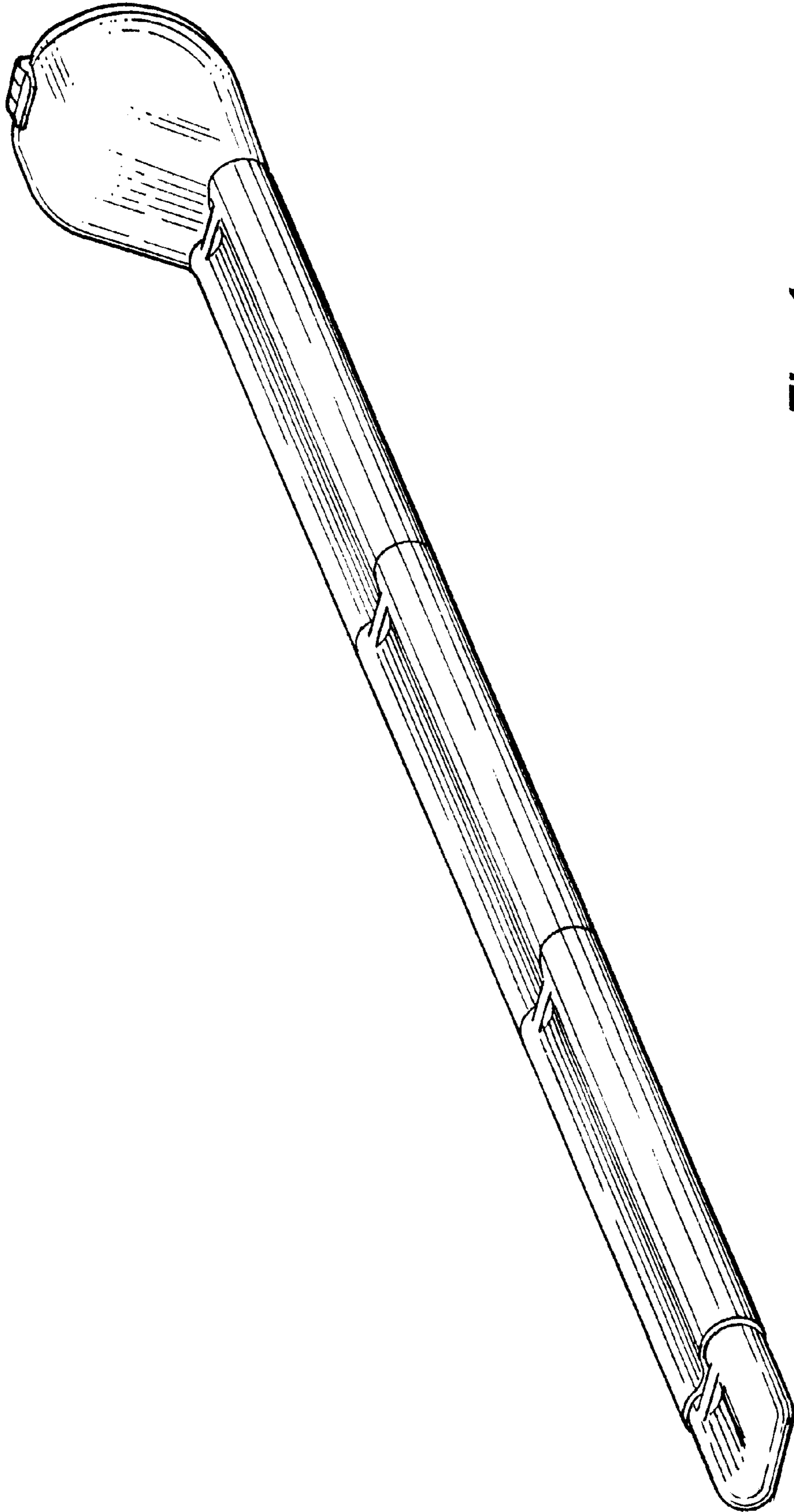

Fig. 1

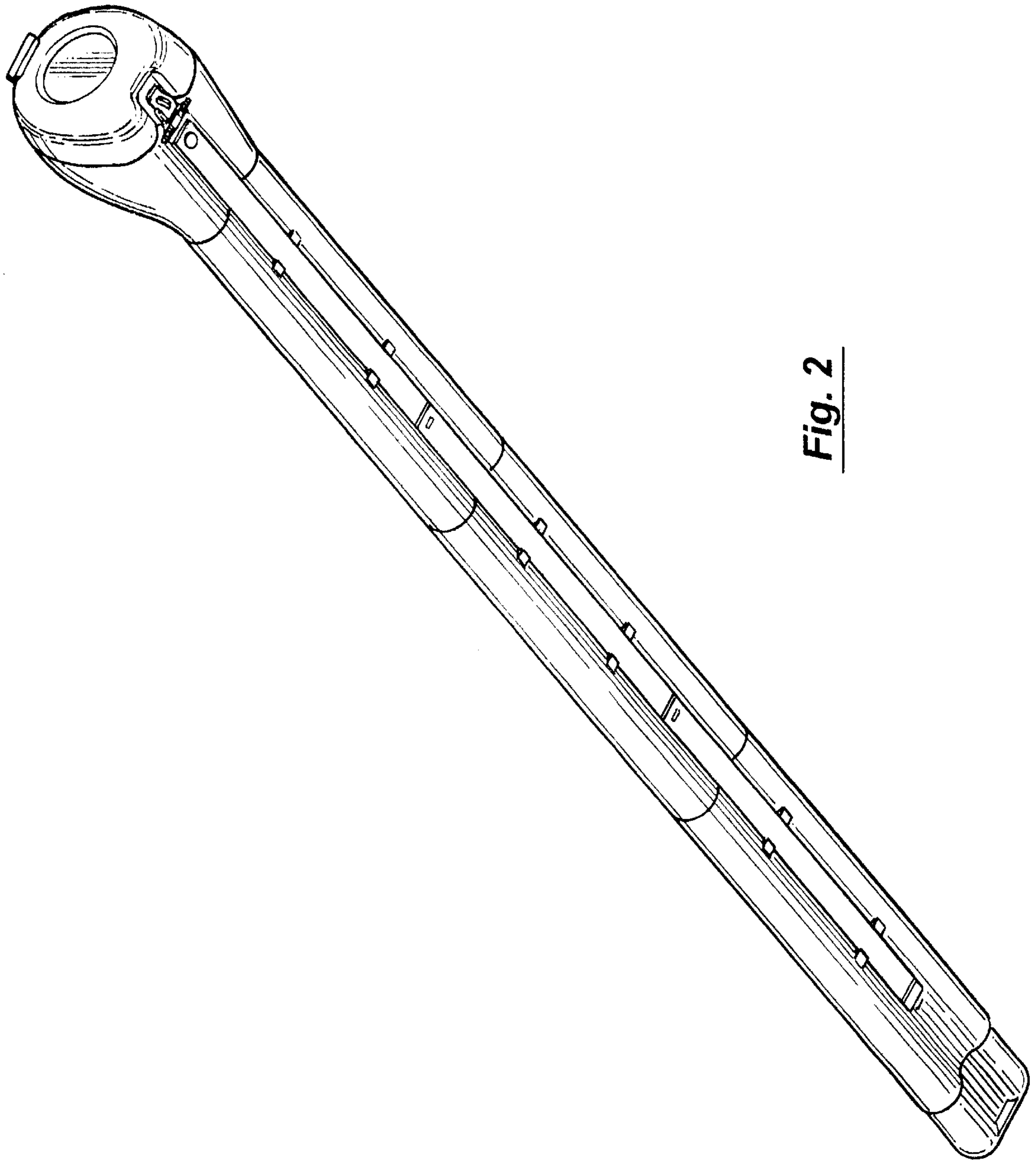

Fig. 2

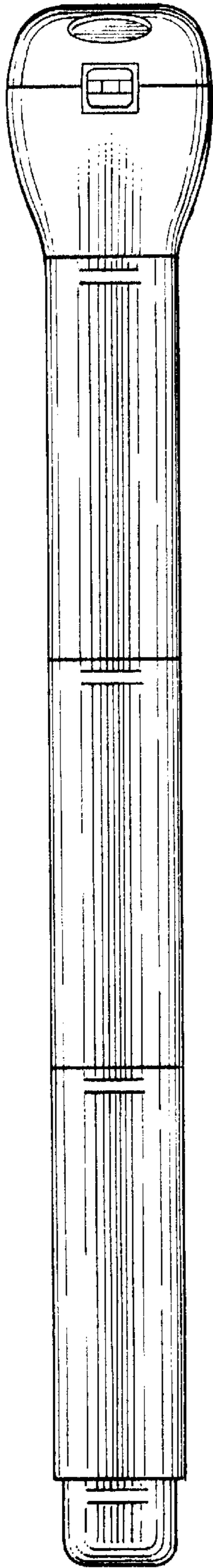

Fig. 3

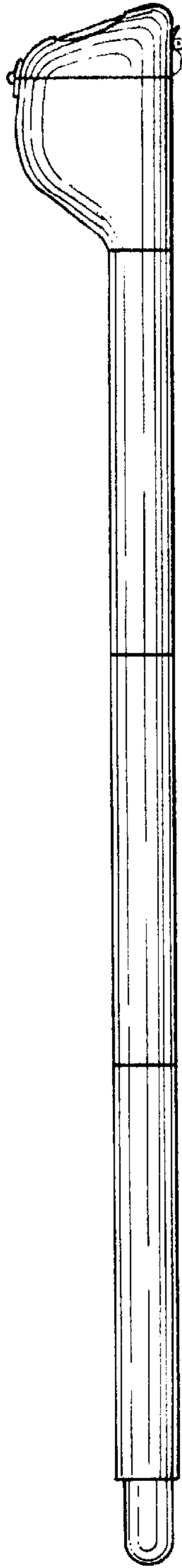

Fig. 4

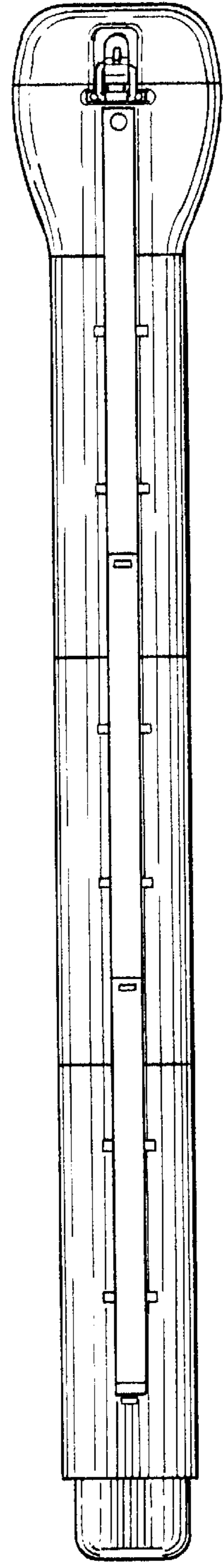

Fig. 5

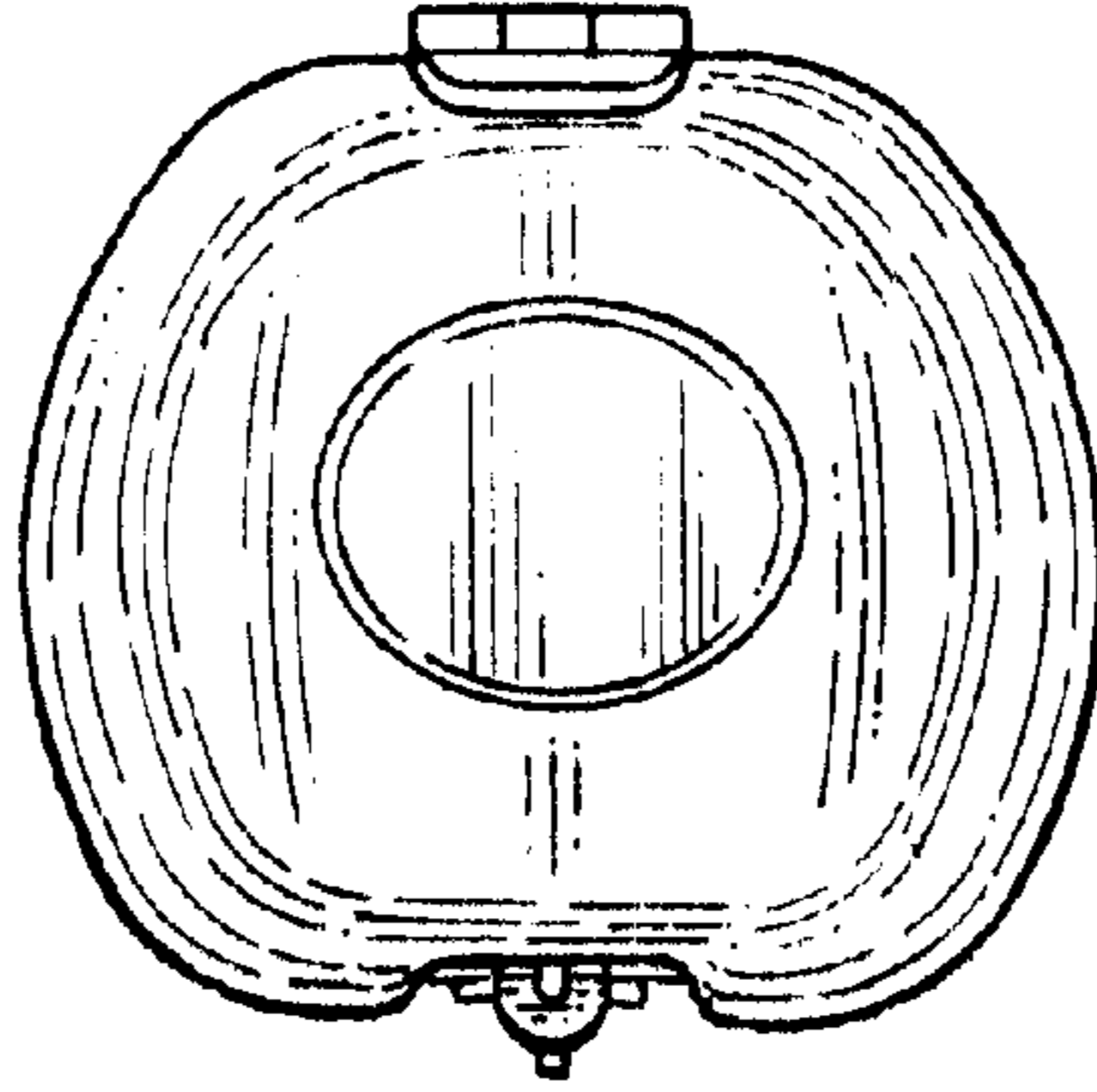

Fig. 6

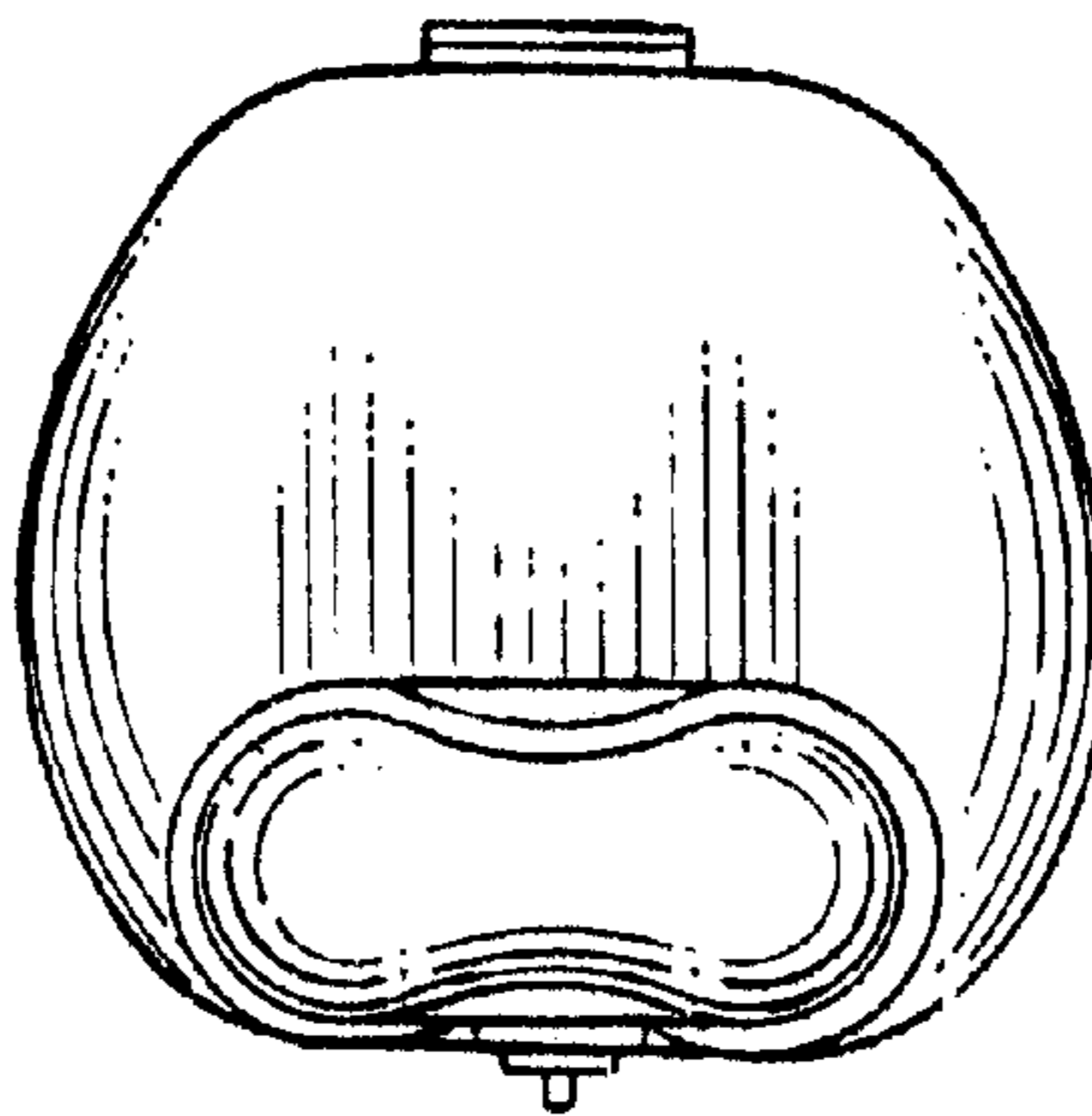

Fig. 7