



US00D458742S

(12) **United States Design Patent**
Crary et al.

(10) **Patent No.:** **US D458,742 S**
(45) **Date of Patent:** **** Jun. 18, 2002**

(54) **FOOTWEAR HEEL PORTION**
(75) Inventors: **Nathan Crary**, Los Alamitos; **Lantz Simpson**, Los Angeles, both of CA (US)
(73) Assignee: **L L International Shoe Company**, Los Angeles, CA (US)
(**) Term: **14 Years**

D383,300 S 9/1997 Teague
D391,065 S 2/1998 Kuerbis
D393,350 S 4/1998 Aveni
D398,743 S 9/1998 Rask
D404,896 S 2/1999 Cooper
D408,120 S 4/1999 Fair
D412,236 S * 7/1999 Von Conta D1/946
D418,282 S * 1/2000 Von Conta et al. D2/977
D422,128 S 4/2000 Adler
D430,723 S 9/2000 Kim
D432,292 S 10/2000 Kim
D434,547 S 12/2000 Kim
D437,675 S 2/2001 Dahlsten

(21) Appl. No.: **29/146,676**
(22) Filed: **Aug. 15, 2001**

* cited by examiner

(51) **LOC (7) Cl.** **02-99**
(52) **U.S. Cl.** **D2/977**
(58) **Field of Search** D2/896, 902, 907,
D2/946, 969, 972, 973, 977; 36/34 R, 35 R,
42, 34 A, 34 B, 25 R, 28, 32 R, 24.5

Primary Examiner—Dominic Simone
(74) *Attorney, Agent, or Firm*—Greer, Burns & Crain, Ltd.

(56) **References Cited**

(57) **CLAIM**

The ornamental design for a footwear heel portion, as shown and described.

U.S. PATENT DOCUMENTS

DESCRIPTION

D157,034 S 1/1950 Eldon
5,003,708 A 4/1991 Daley
D324,131 S 2/1992 Lucas
D325,288 S * 4/1992 Richard et al. D2/977
D325,289 S 4/1992 Aveni
D327,362 S 6/1992 Hatfield
D329,732 S 9/1992 Molet et al.
D330,798 S 11/1992 Hatfield et al.
D332,861 S * 2/1993 Worthington D2/977
D334,652 S 4/1993 Hatfield
D336,765 S 6/1993 Cohen
D336,771 S 6/1993 Hatfield et al.
D341,932 S 12/1993 Elliot
D355,527 S * 2/1995 Yoshikawa et al. D2/977
D356,884 S 4/1995 Ho
D363,813 S 11/1995 Gay
D378,011 S 2/1997 Lucas
D383,294 S 9/1997 Lozano

FIG. 1 is a perspective view from the medial side of an article of footwear heel portion comprising the design of the invention.
FIG. 2 is a perspective view of a footwear heel portion article comprising the design of the invention.
FIG. 3 is a medial side elevational view of the article of FIG. 2.
FIG. 4 is a lateral side elevational view of the article of FIG. 2.
FIG. 5 is a rear elevational view of the article of FIG. 2.
FIG. 6 is a front elevational view of the article of FIG. 2.
FIG. 7 is a top plan view of the article of FIG. 2; and, FIG. 8 is a bottom plan view of the article of FIG. 2.
The broken line showing of FIGS. 1-8 is for illustrative purposes only and forms no part of the present invention.

1 Claim, 4 Drawing Sheets

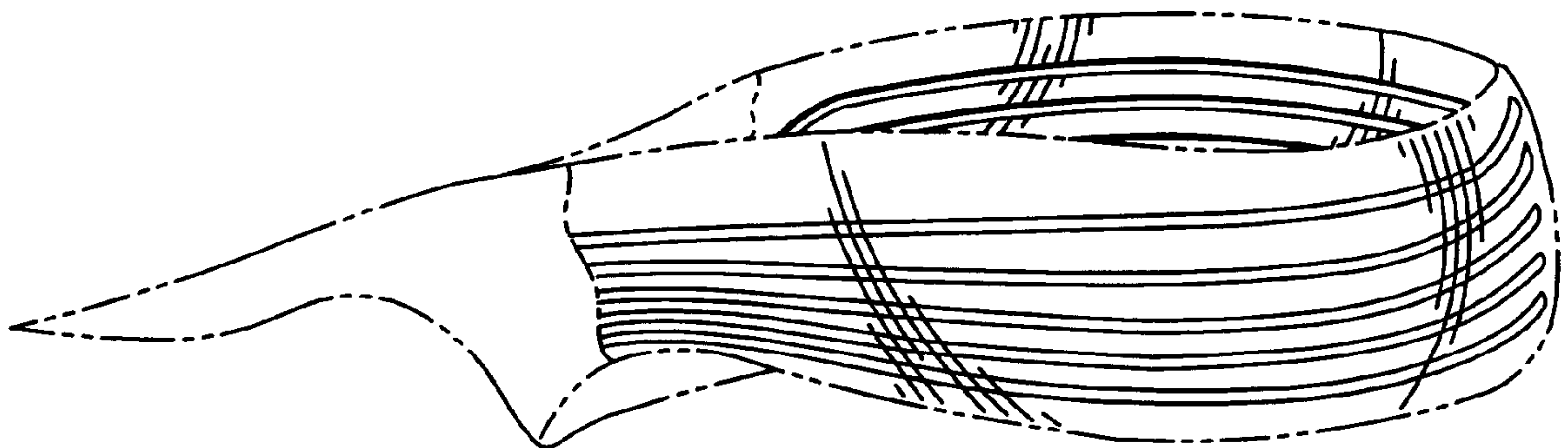

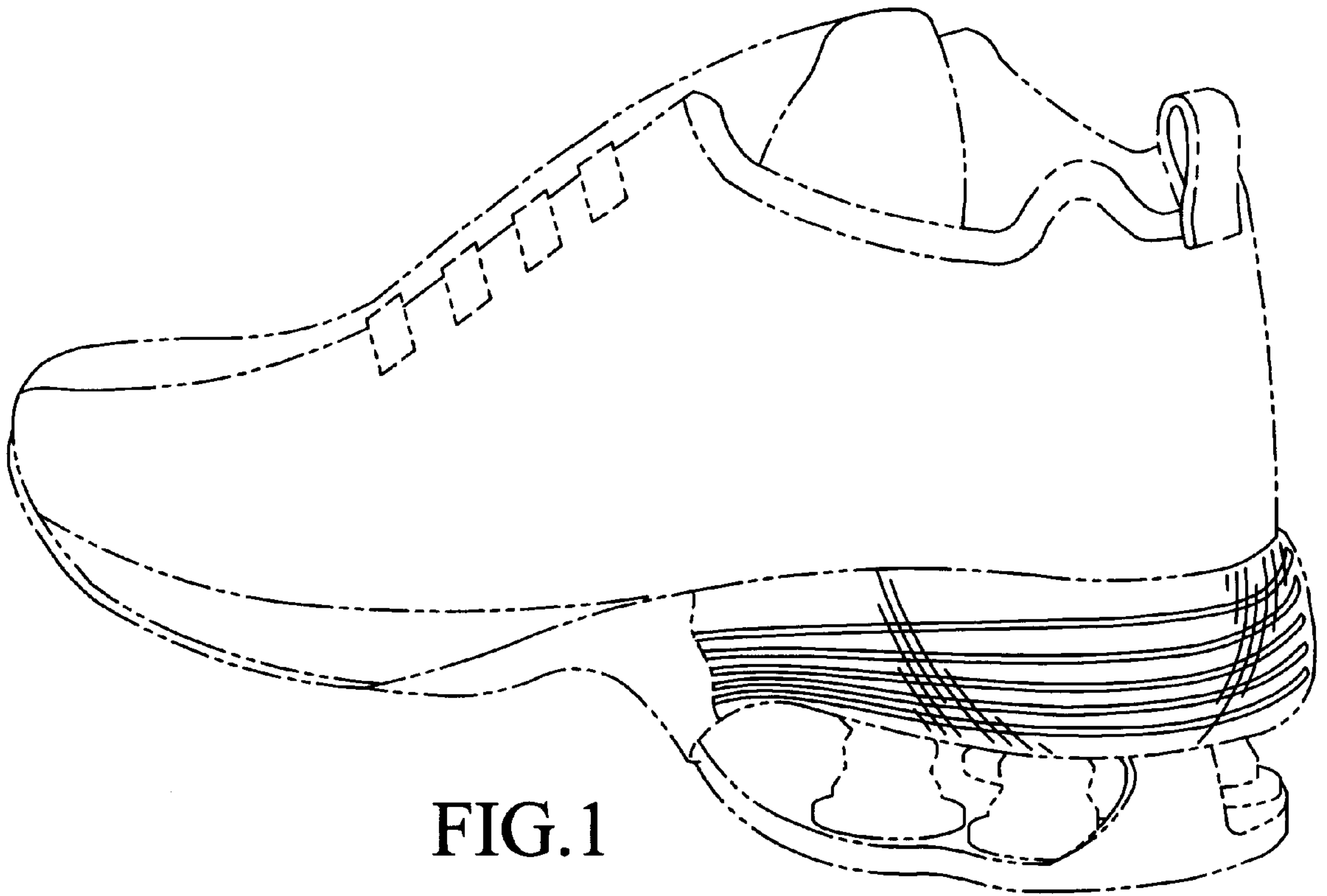

FIG. 1

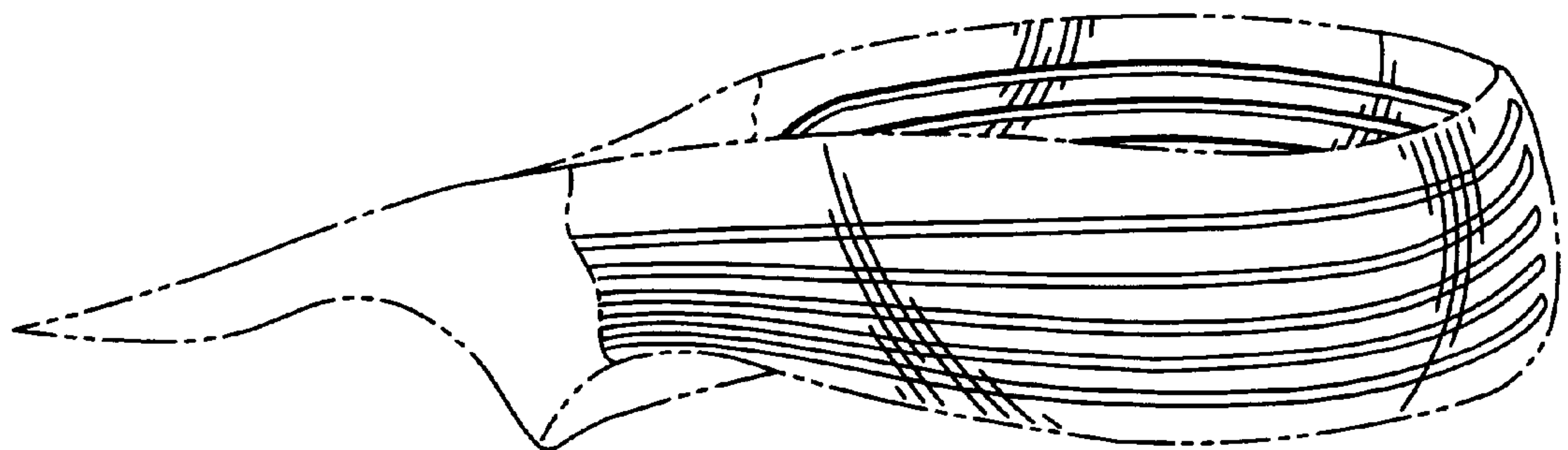

FIG. 2

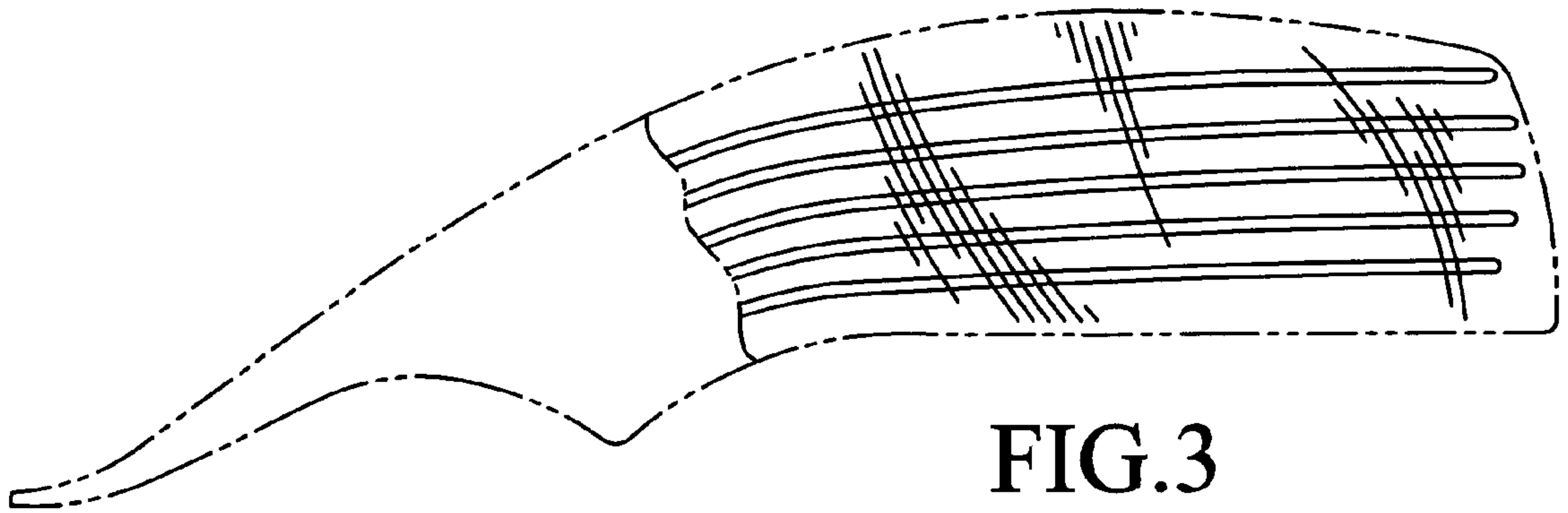

FIG. 3

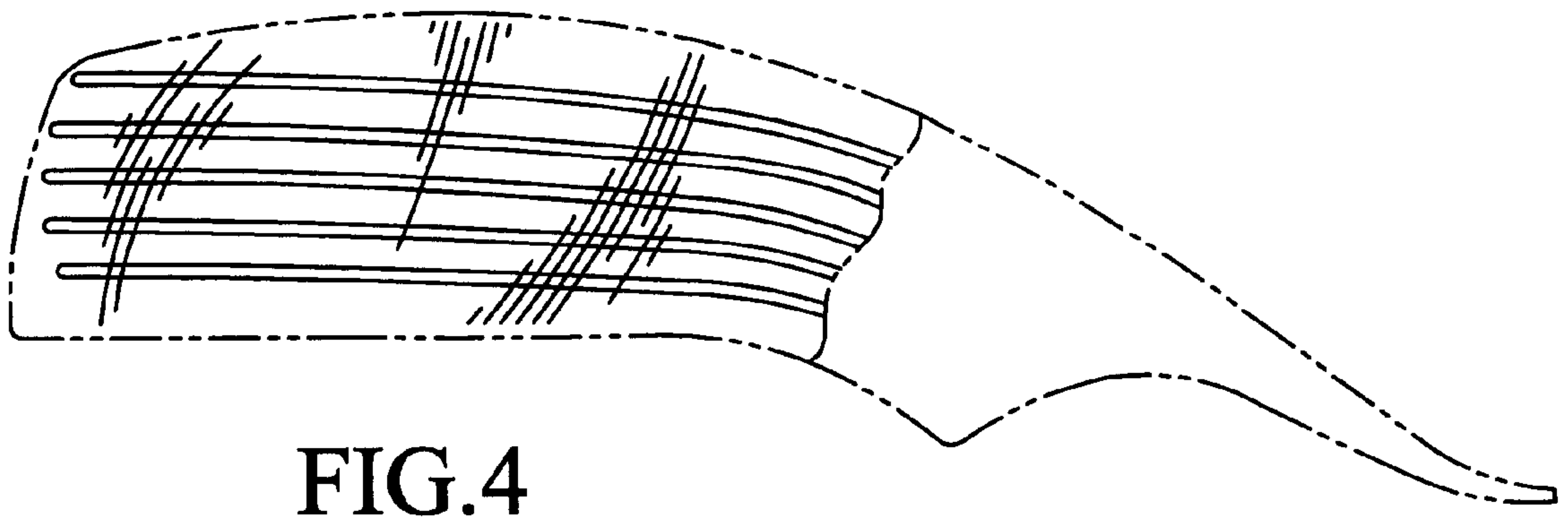

FIG. 4

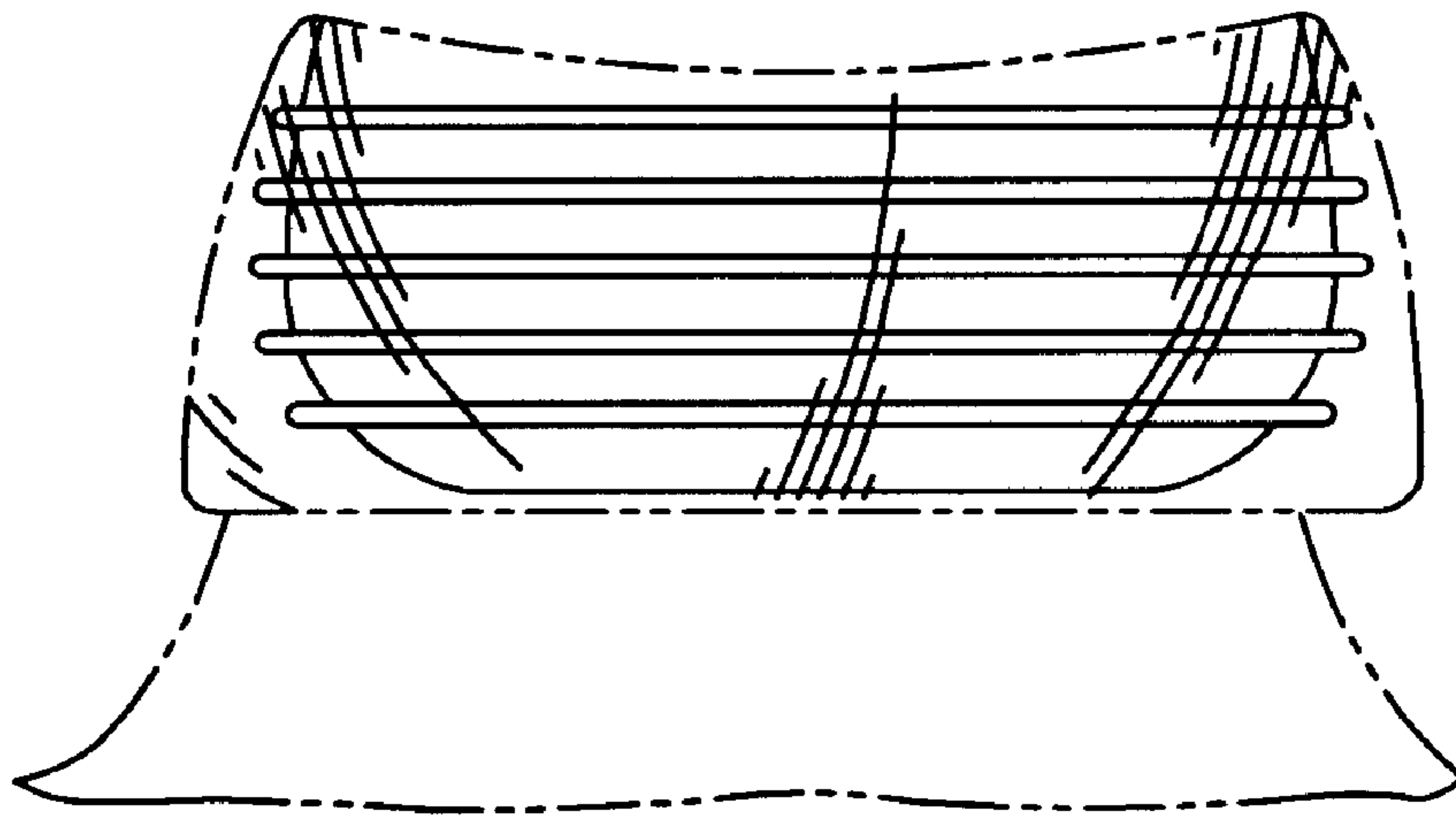

FIG. 5

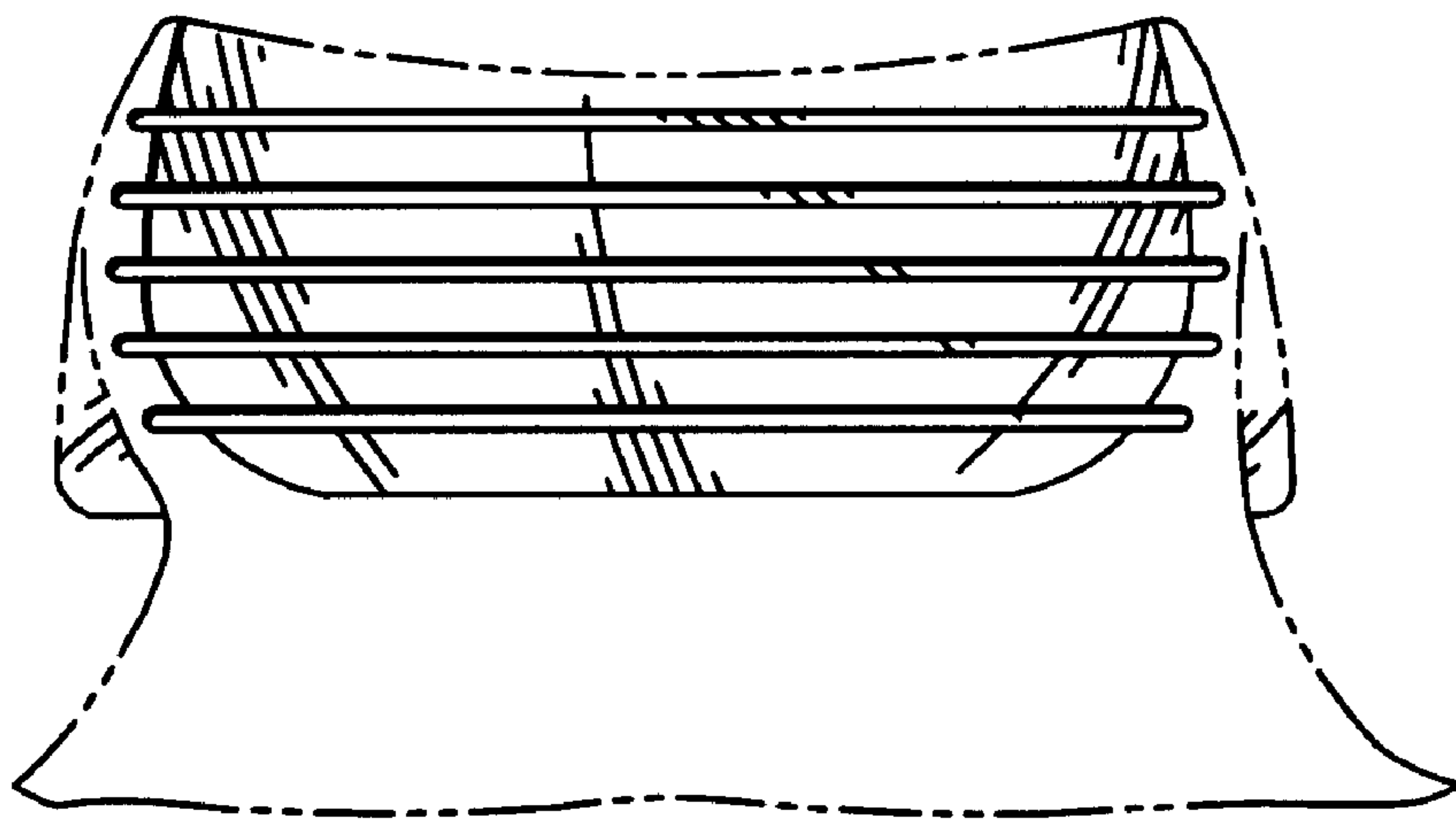

FIG. 6

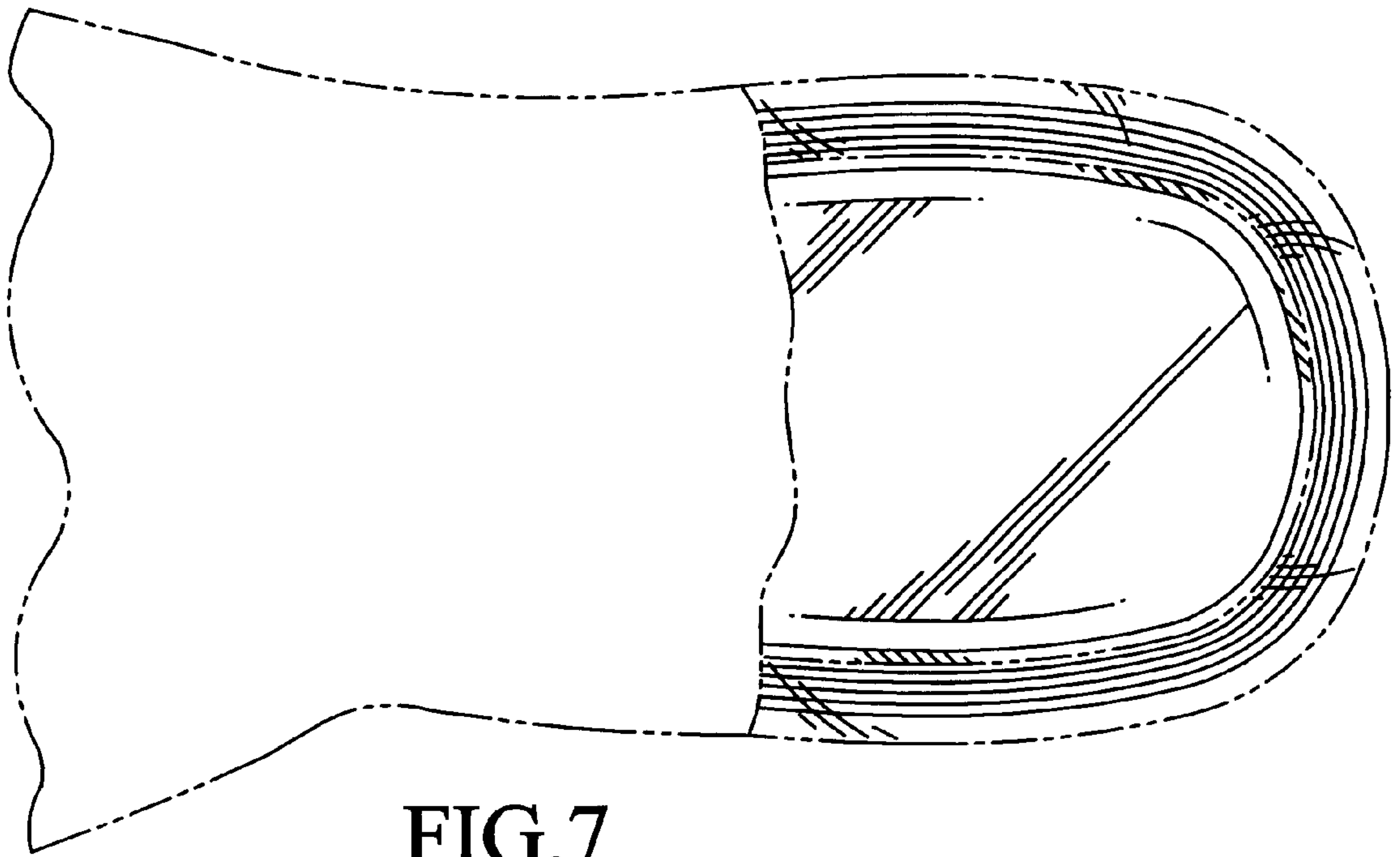

FIG. 7

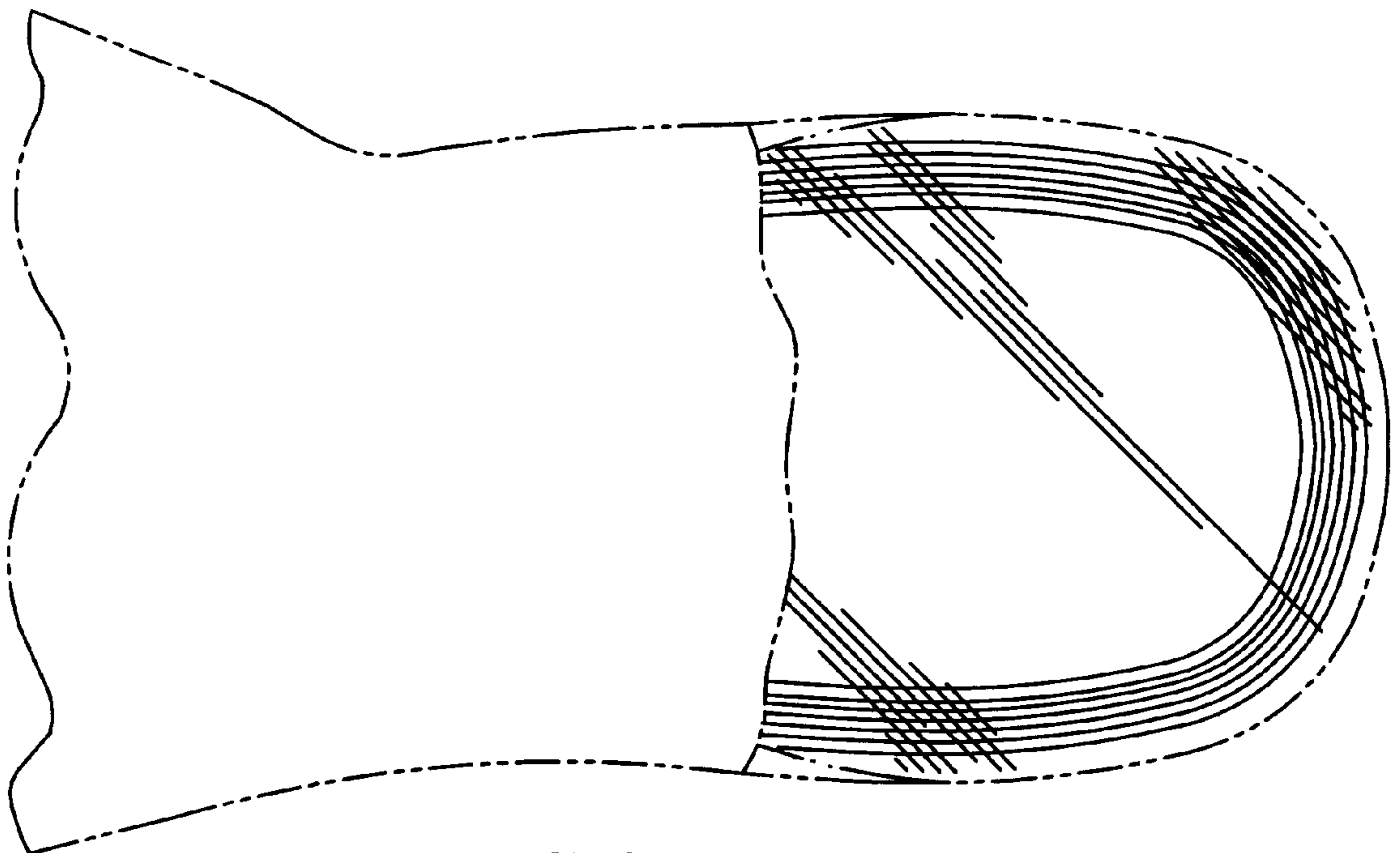

FIG. 8