



US00D458719S

(12) **United States Design Patent**
Waldron et al.

(10) **Patent No.:** **US D458,719 S**

(45) **Date of Patent:** **** Jun. 11, 2002**

(54) **POWERHEAD FOR A VACUUM CLEANER**

(75) Inventors: **Michael E. Waldron**, Chester-le-Street;
Mark Stratford, Darlington, both of
(GB); **Gabriel E. Concari**, Eldersburg;
Stacey A. Main, Baltimore, both of
MD (US)

(73) Assignee: **Black & Decker Inc.**, Newark, DE
(US)

(**) Term: **14 Years**

(21) Appl. No.: **29/144,789**

(22) Filed: **Jul. 10, 2001**

(51) **LOC (7) Cl.** **15-05**

(52) **U.S. Cl.** **D32/21; D32/18**

(58) **Field of Search** D32/21, 25, 31-33,
D32/17-18; 15/329, 344, 320, 353

(56) **References Cited**

U.S. PATENT DOCUMENTS

D220,970 S	6/1971	Rawson et al.	
D275,504 S	* 9/1984	Miura	D21/526
4,665,582 A	5/1987	Richmond et al.	
4,798,613 A	* 1/1989	Hetherington et al.	95/267
D303,170 S	* 8/1989	Hirano	D32/18
D304,104 S	10/1989	Busalt et al.	
D307,657 S	5/1990	Li	
4,928,346 A	5/1990	Elson et al.	
D315,816 S	* 3/1991	Ferrari et al.	D32/18
D355,283 S	* 2/1995	Thomas et al.	D32/24

D399,618 S	10/1998	Jacobs	
D421,671 S	3/2000	Thomas et al.	
D422,763 S	* 4/2000	Tsuda	D32/21
D437,666 S	2/2001	Park	
D441,152 S	4/2001	Stratford	
D443,119 S	* 5/2001	Sung	D32/21
D448,128 S	* 9/2001	Oh	D32/21
D452,594 S	* 12/2001	Rosa	D32/21

OTHER PUBLICATIONS

Photograph of Black & Decker 3-in-1 Vacuum Cleaner System; publication date at least as early as Jan., 1996.

* cited by examiner

Primary Examiner—Ruth McInroy

(74) *Attorney, Agent, or Firm*—Harness, Dickey & Pierce, P.L.C.

(57) **CLAIM**

We claim the ornamental design for a powerhead for a vacuum cleaner, as shown and described.

DESCRIPTION

FIG. 1 is a front-right perspective view of a powerhead for a vacuum cleaner showing our new design; FIG. 2 is a front elevational view thereof; FIG. 3 is a rear elevational view thereof; FIG. 4 is a right side elevational view thereof; FIG. 5 is a left side elevational view thereof; FIG. 6 is a top plan view thereof; and, FIG. 7 is a bottom plan view thereof.

1 Claim, 5 Drawing Sheets

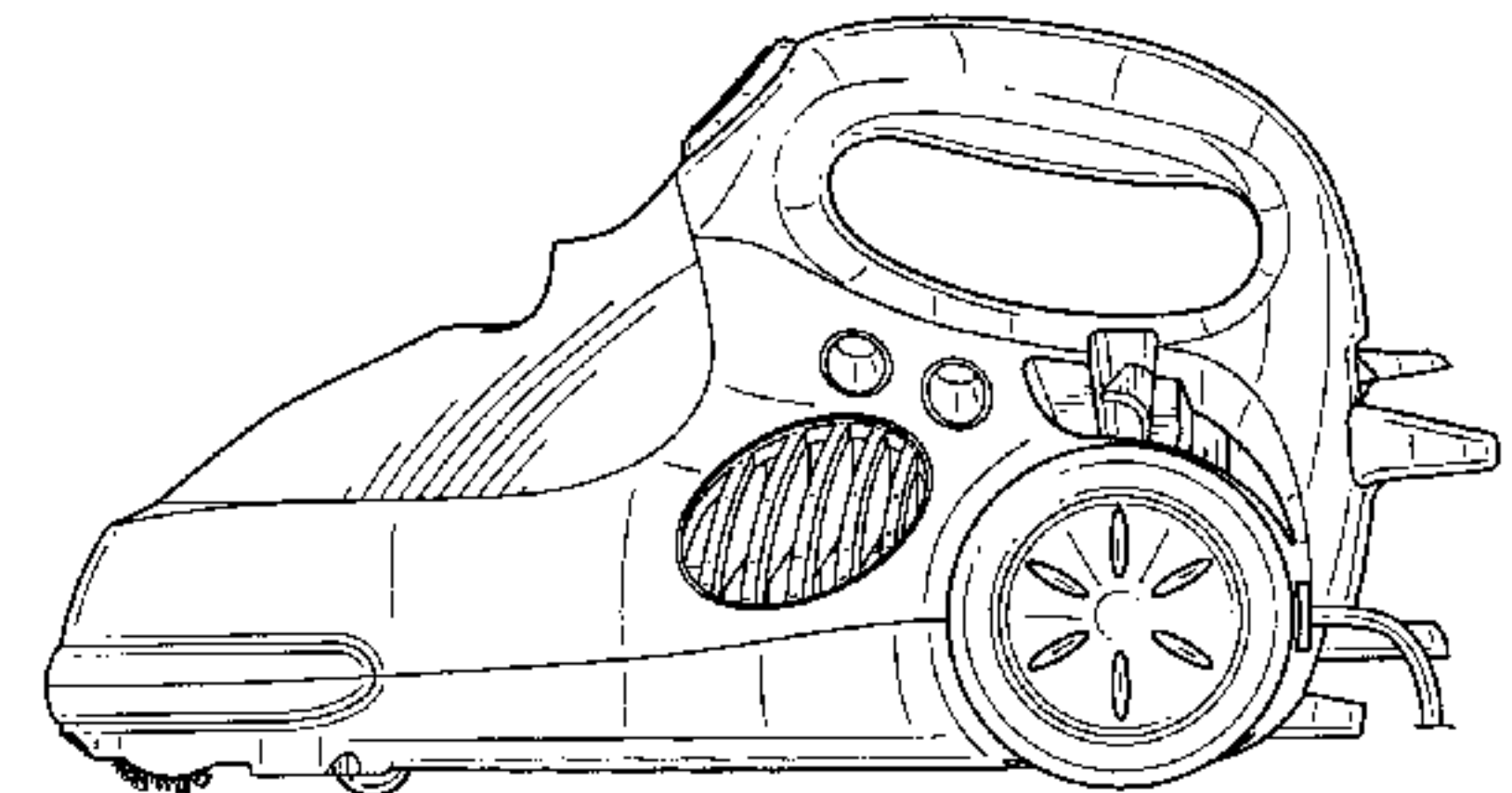
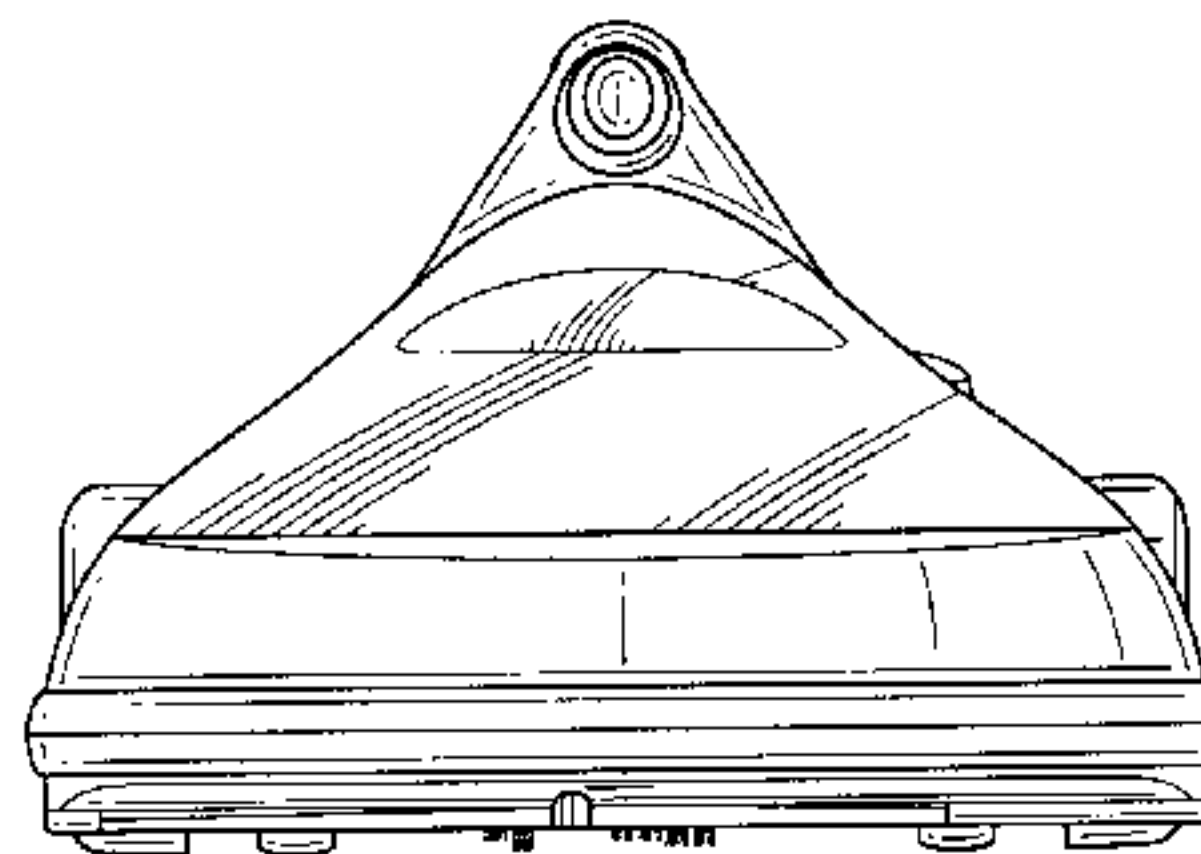
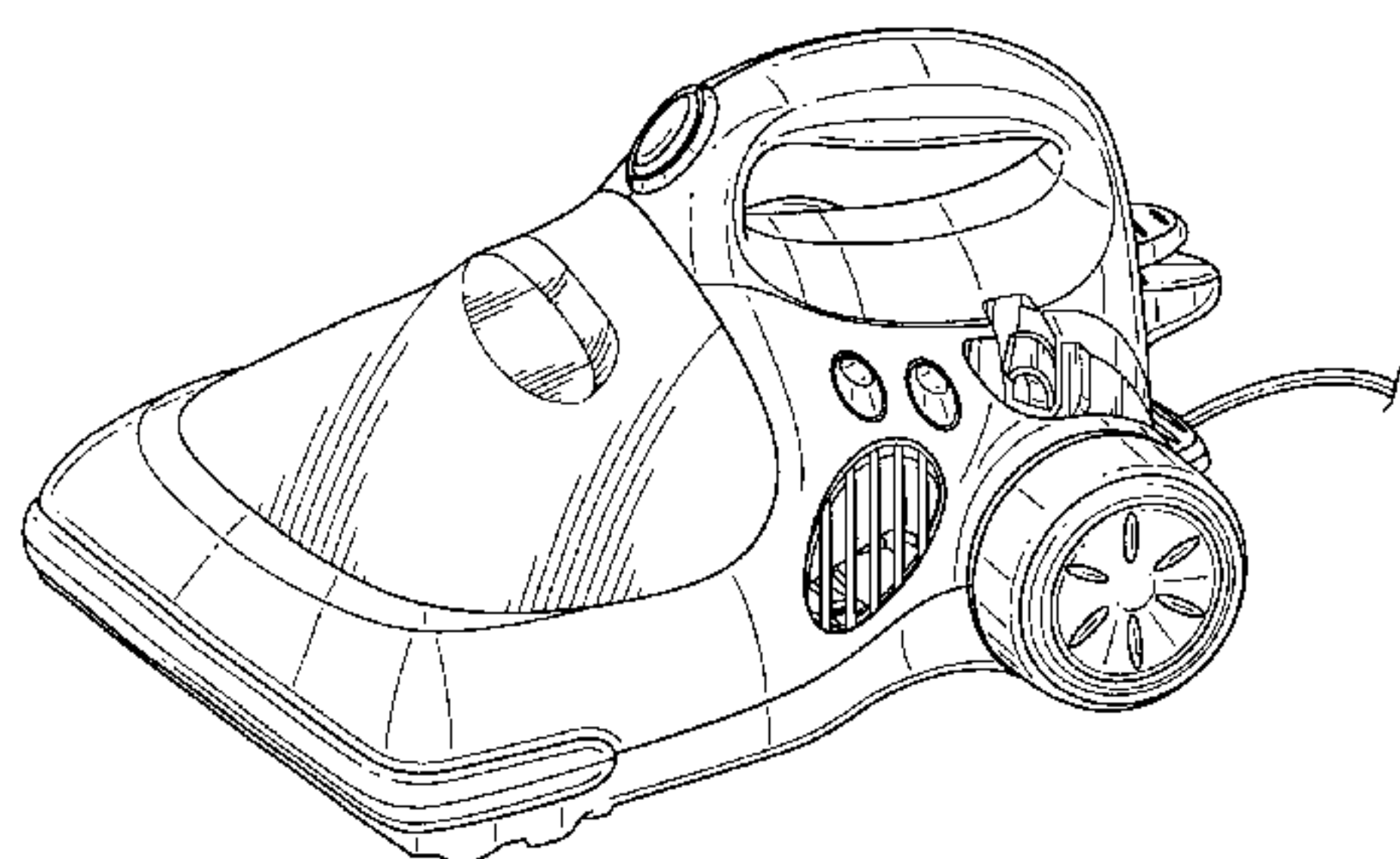

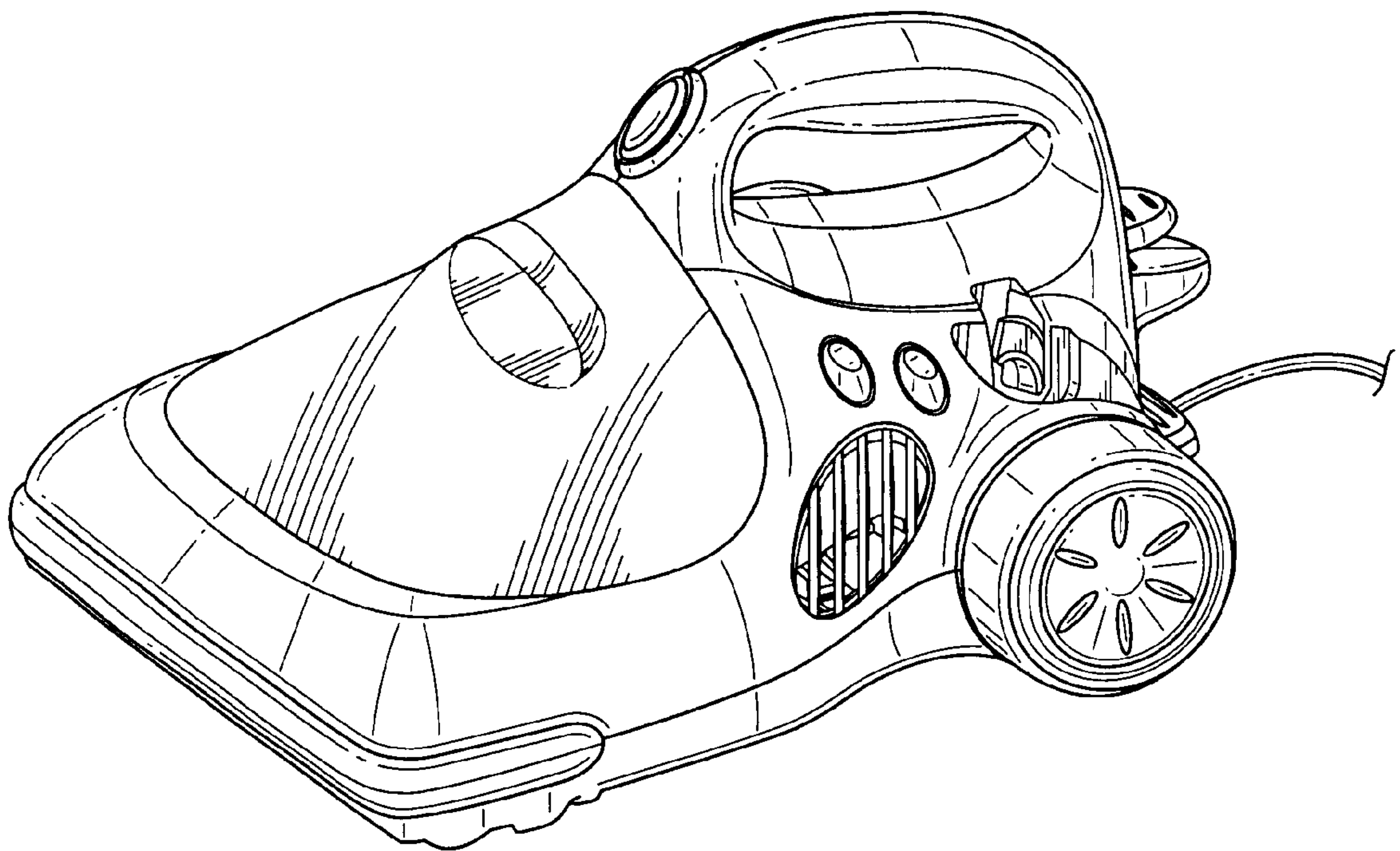

FIG. 1

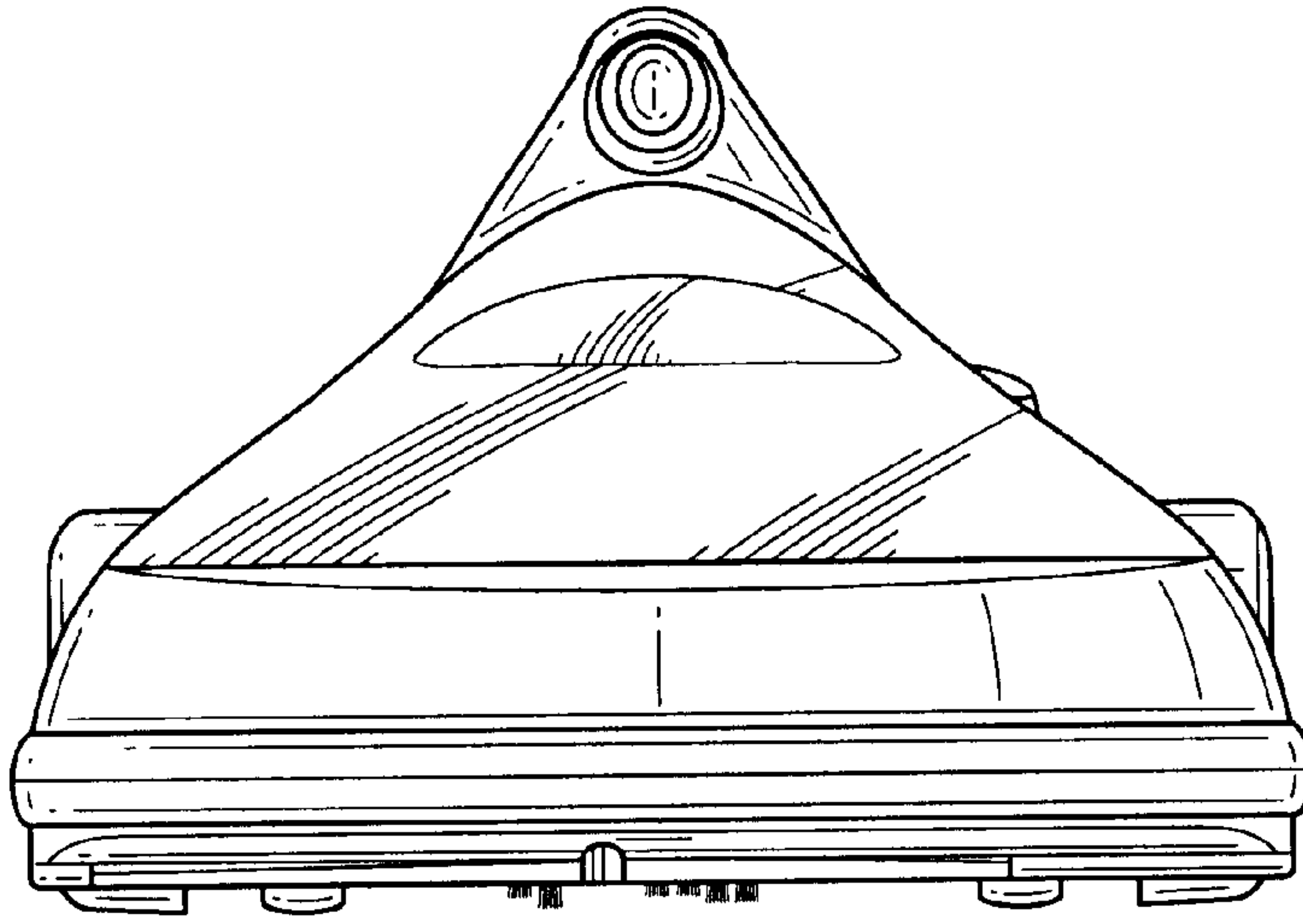

FIG. 2

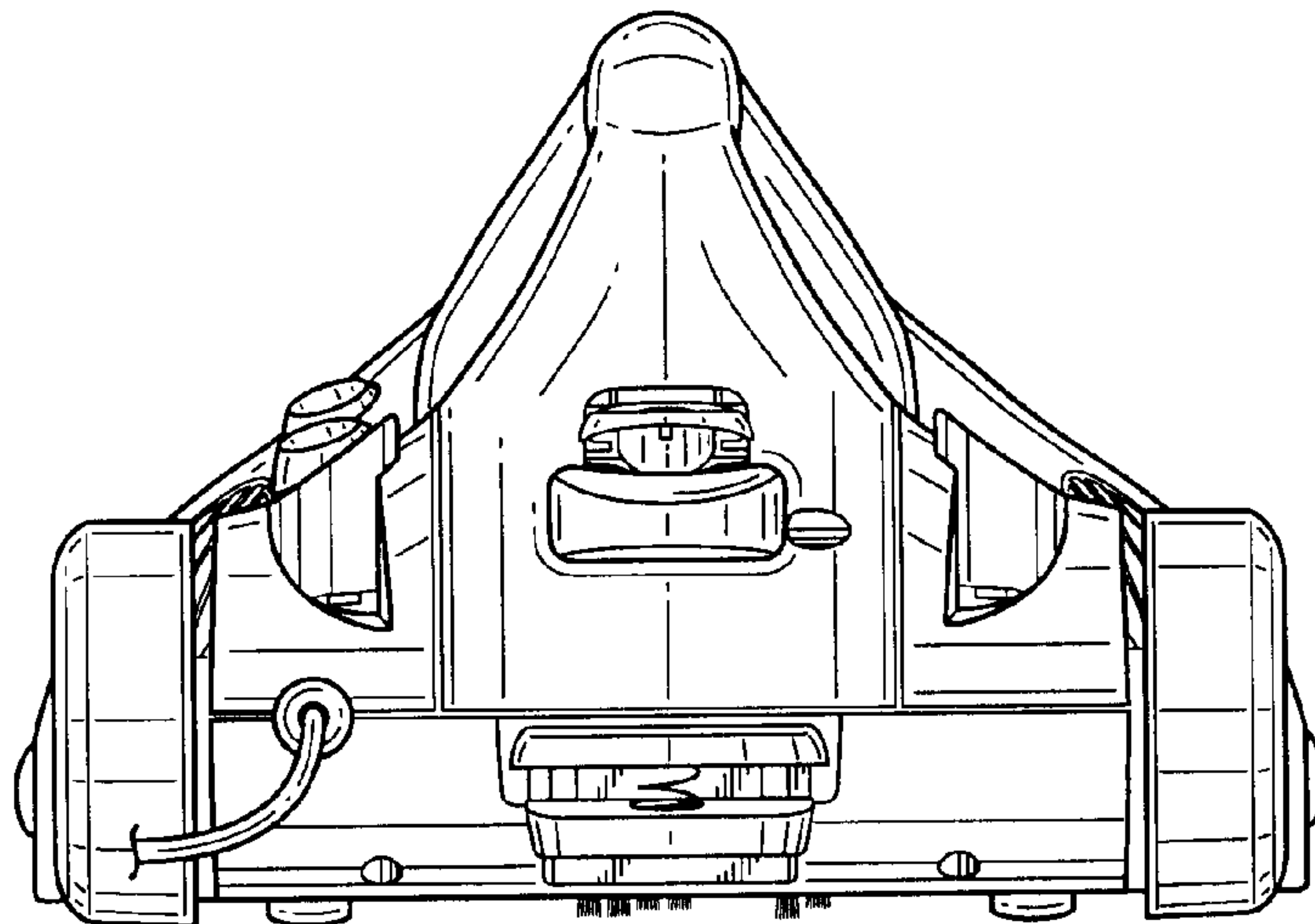

FIG. 3

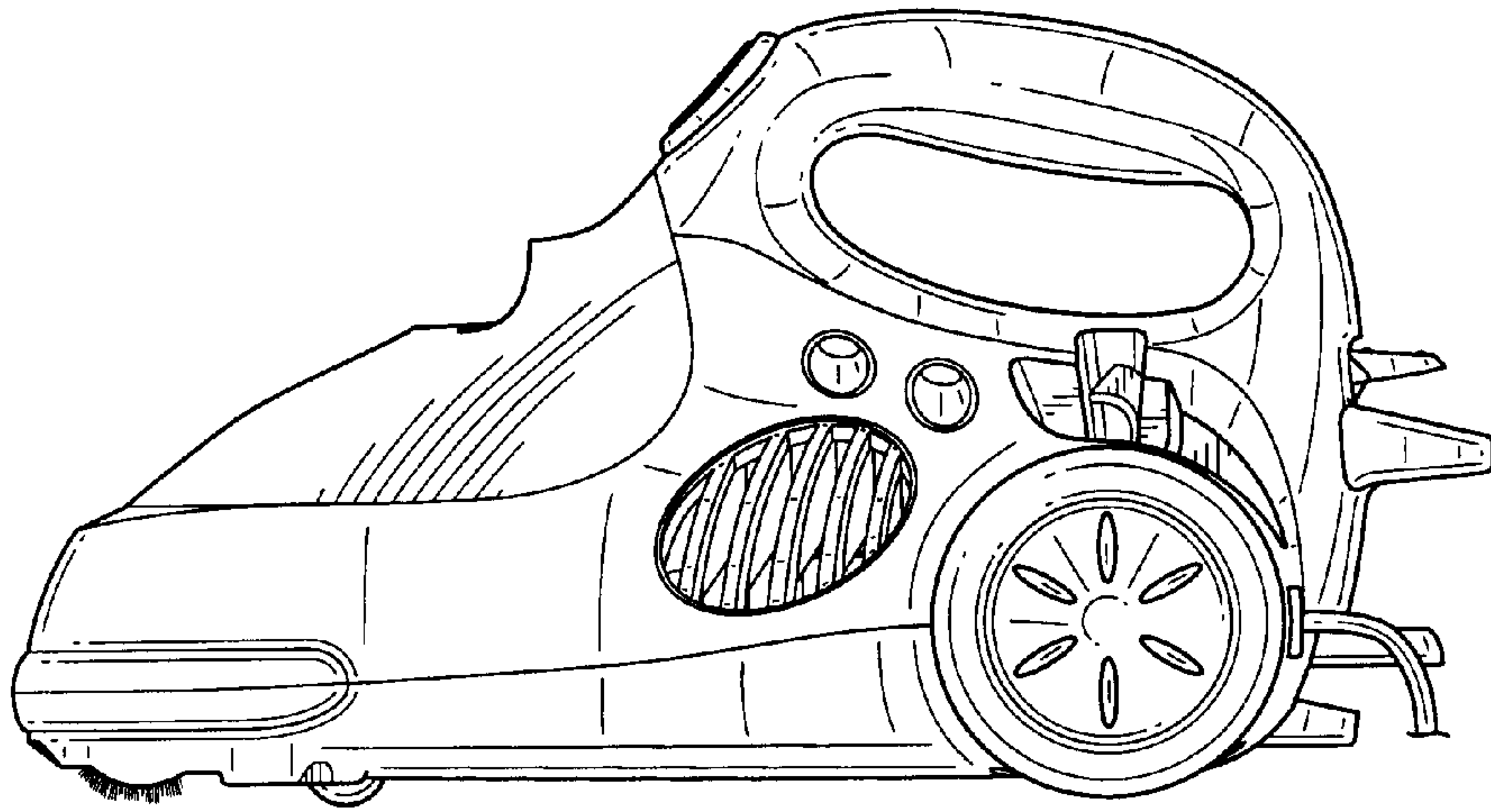

FIG. 4

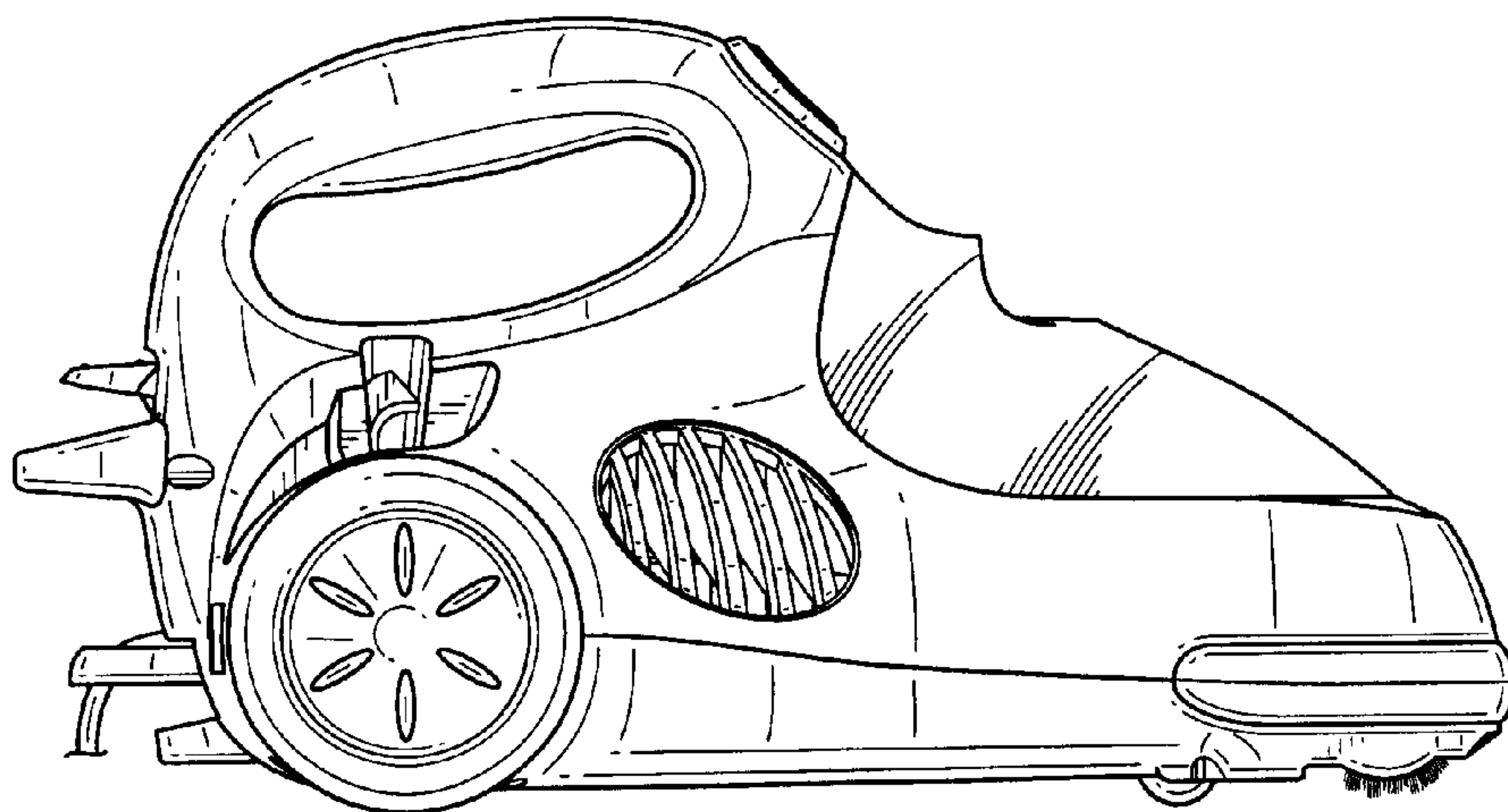

FIG. 5

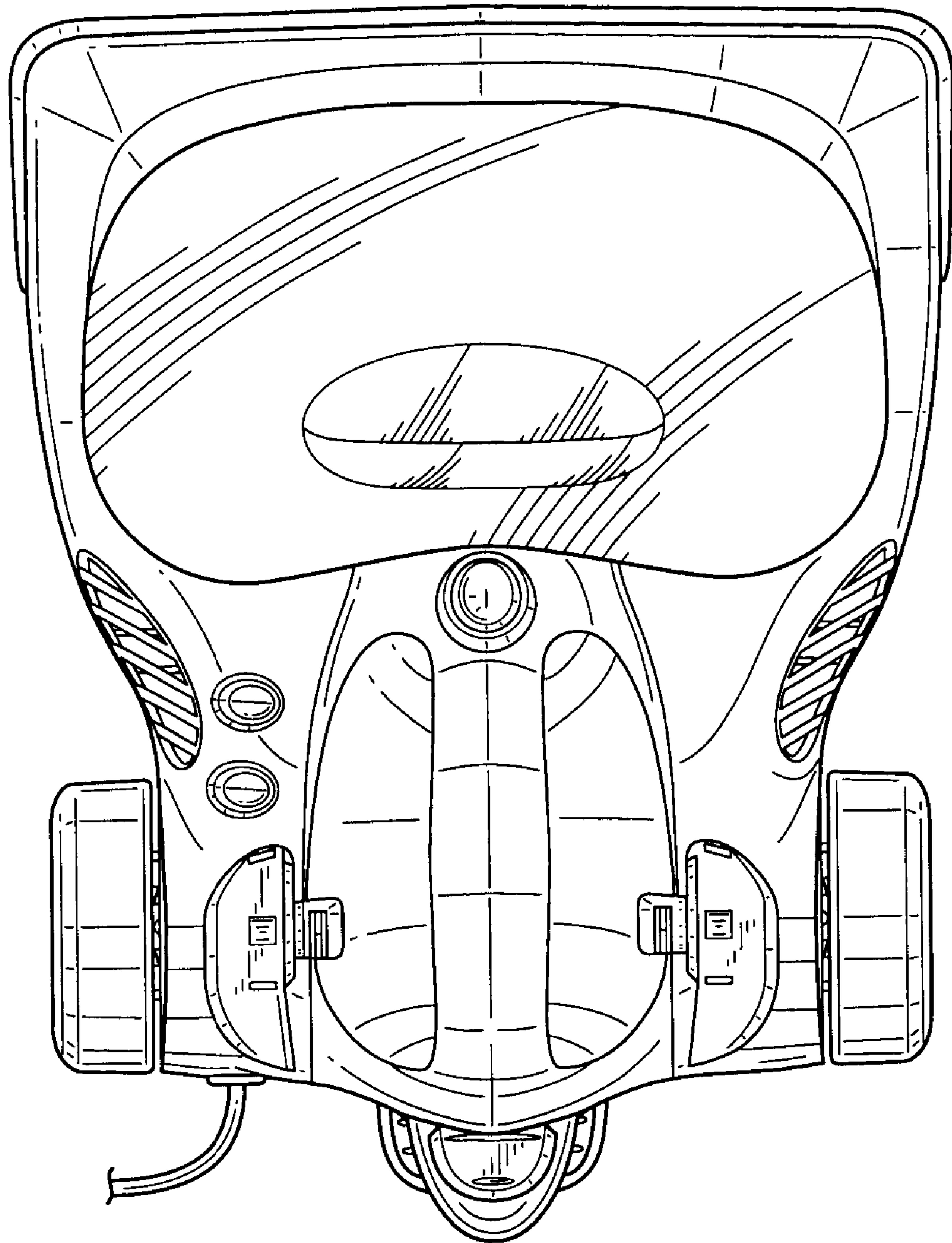

FIG. 6

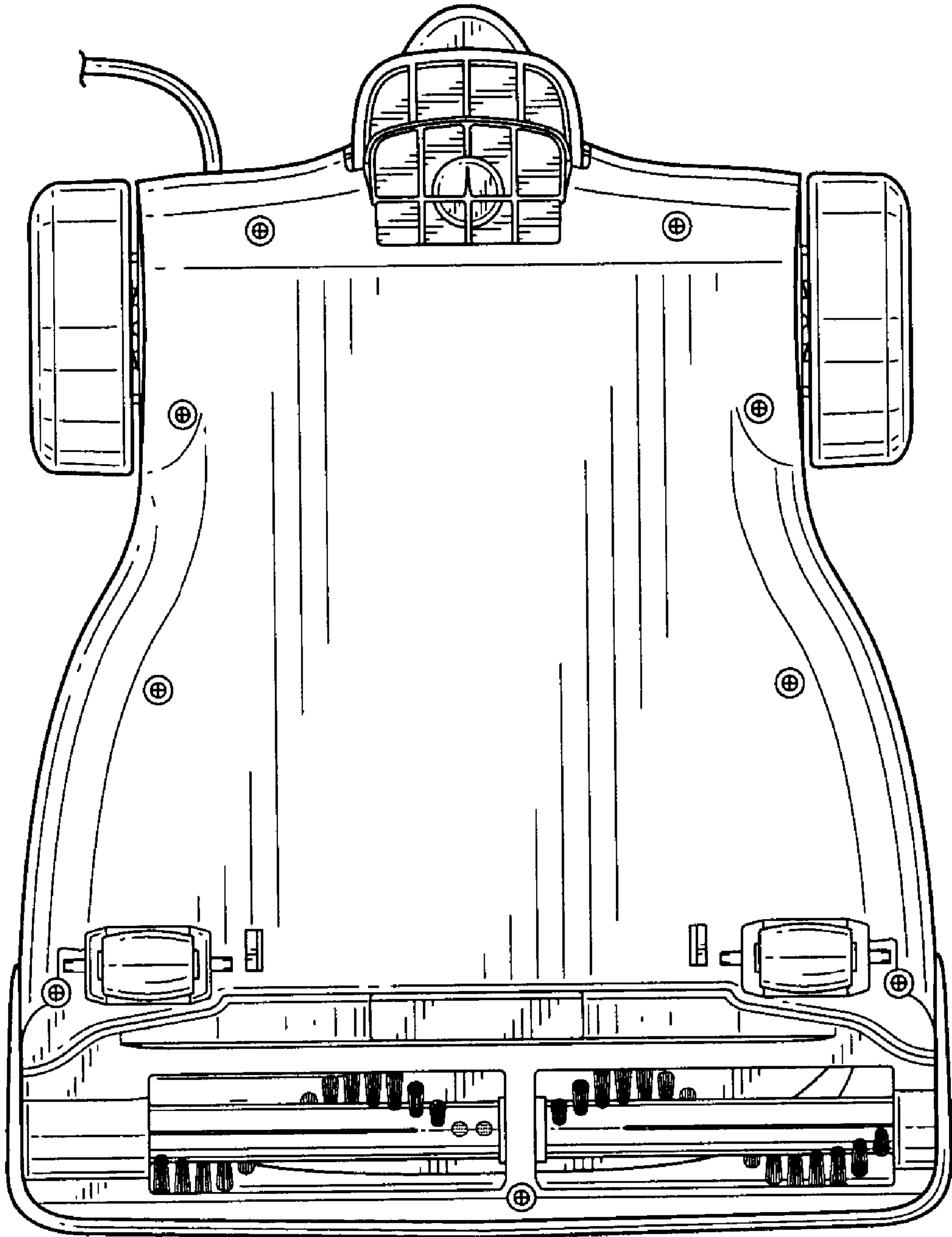

FIG. 7