



US00D458704S

(12) **United States Design Patent**
Orozco

(10) **Patent No.:** **US D458,704 S**

(45) **Date of Patent:** **** Jun. 11, 2002**

(54) **LIGHT FIXTURE**

(75) Inventor: **Sergio J. Orozco**, West New York, NJ (US)

(73) Assignee: **Quoizel, Inc.**, Goose Creek, SC (US)

(**) Term: **14 Years**

(21) Appl. No.: **29/147,742**

(22) Filed: **Sep. 5, 2001**

(51) **LOC (7) Cl.** **26-03**

(52) **U.S. Cl.** **D26/92**

(58) **Field of Search** D26/72-74, 80-87,
D26/92; 362/147, 432, 363, 367, 368

(56) **References Cited**

U.S. PATENT DOCUMENTS

D438,324 S * 2/2001 Pham D26/72

OTHER PUBLICATIONS

Framburg Catalog 2000, p. 159, item No. 8568.*

* cited by examiner

Primary Examiner—Alan P. Douglas

Assistant Examiner—Clare E. Heflin

(74) *Attorney, Agent, or Firm*—Nelson Mullins Riley & Scarborough

(57) **CLAIM**

The ornamental design of a light fixture, substantially as shown and described.

DESCRIPTION

FIG. 1 is a perspective view of a light fixture embodying the design of the present invention.

FIG. 2 is a right side elevational view of the light fixture illustrated in FIG. 1, with the left side elevational view being identical thereto.

FIG. 3 is a front side elevational view of the light fixture of FIG. 1.

FIG. 4 is a back side elevational view of the light fixture of FIG. 1.

FIG. 5 is a top view of the light fixture of FIG. 1; and,

FIG. 6 is a bottom view of the light fixture of FIG. 1.

The mounting bracket shown in broken lines does not form a part of the claimed design.

1 Claim, 6 Drawing Sheets

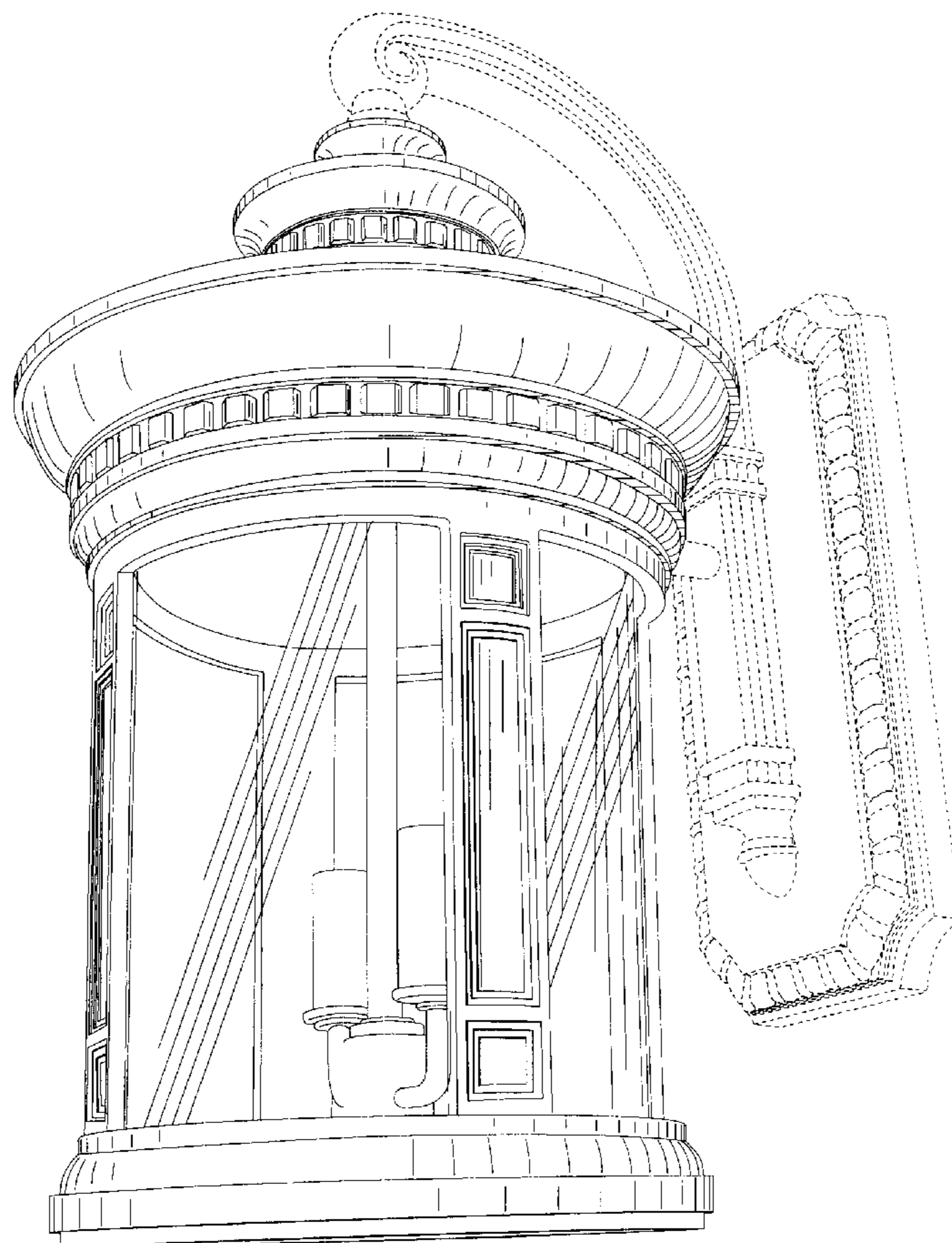

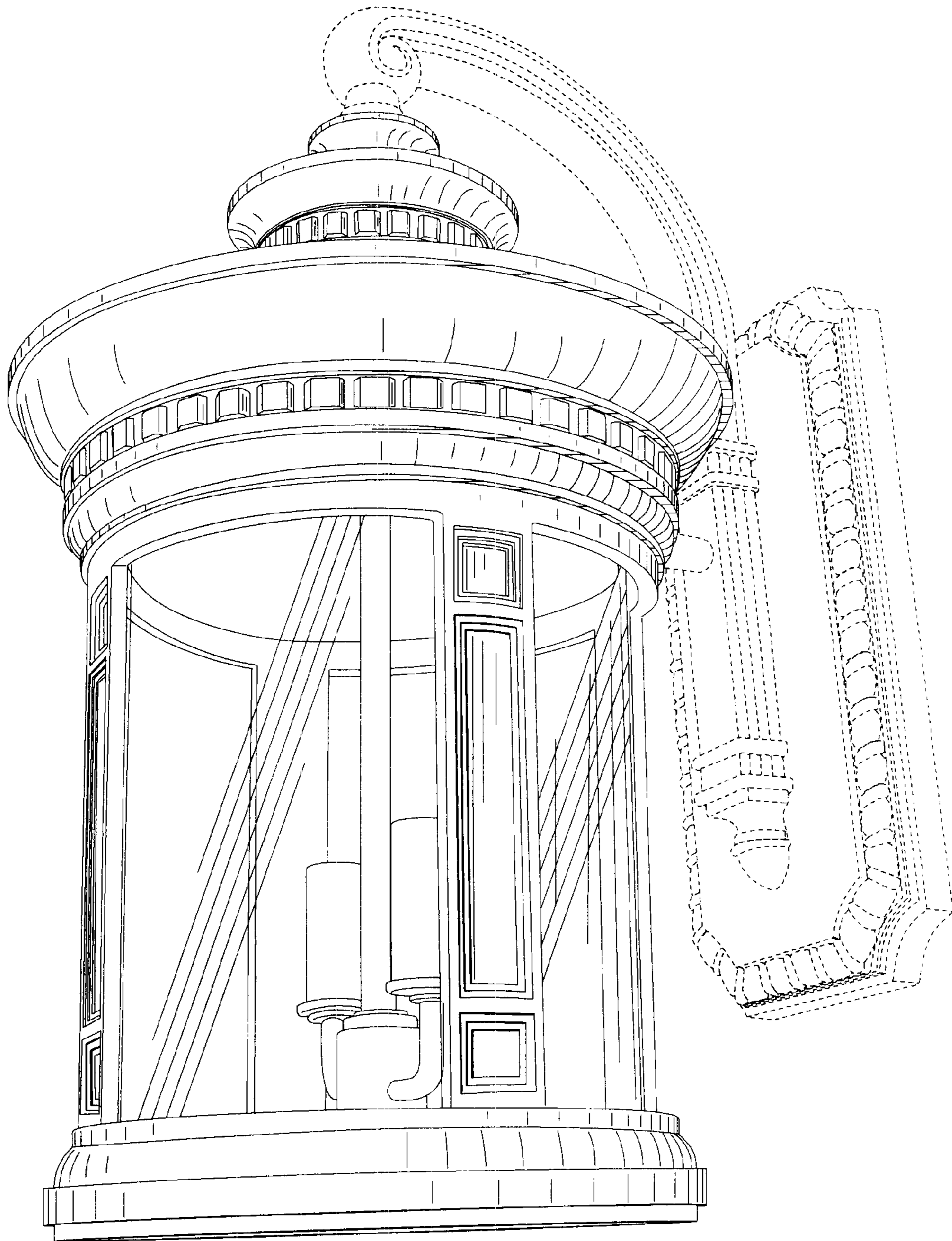

FIG. 1.

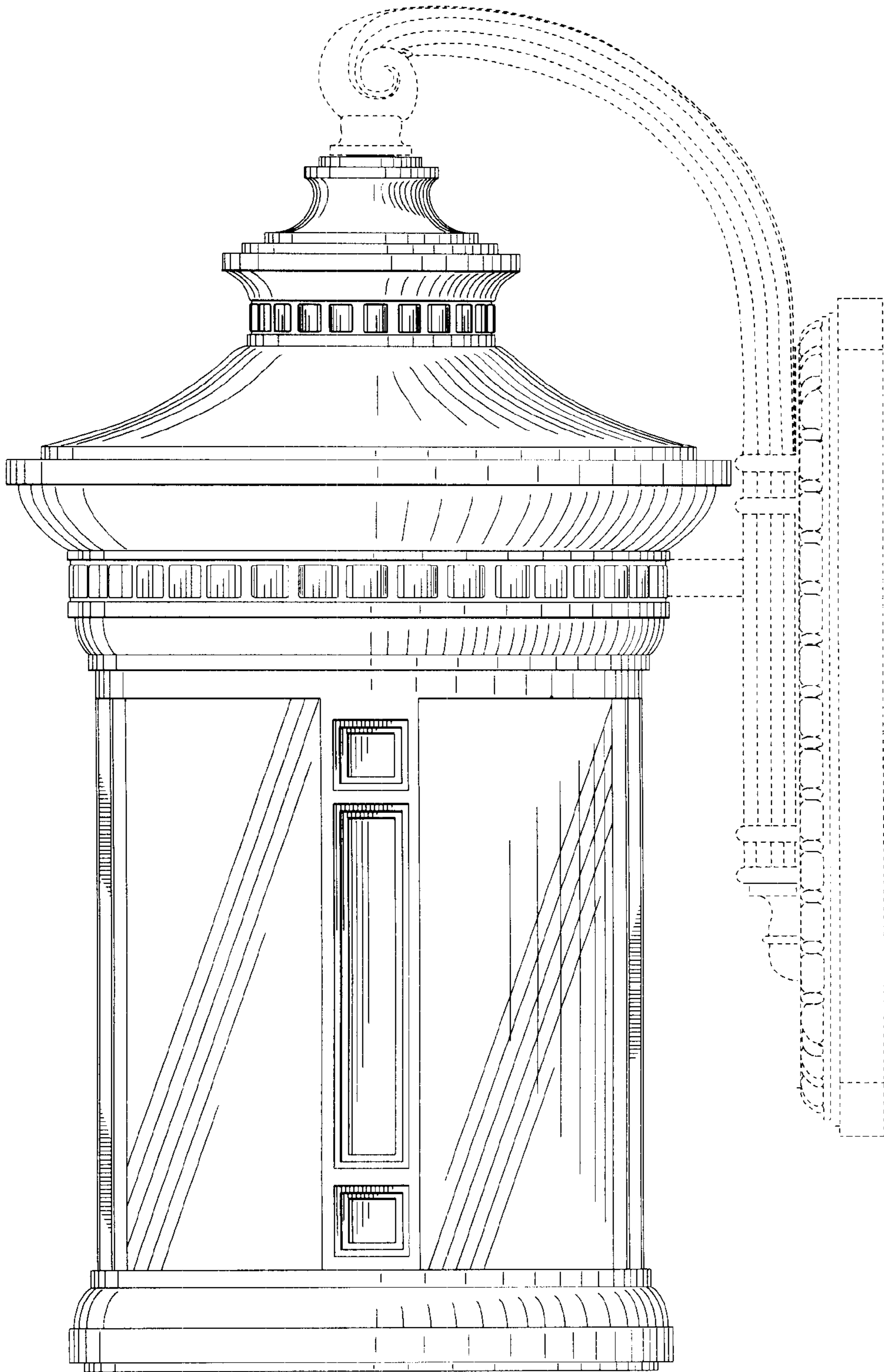

FIG. 2.

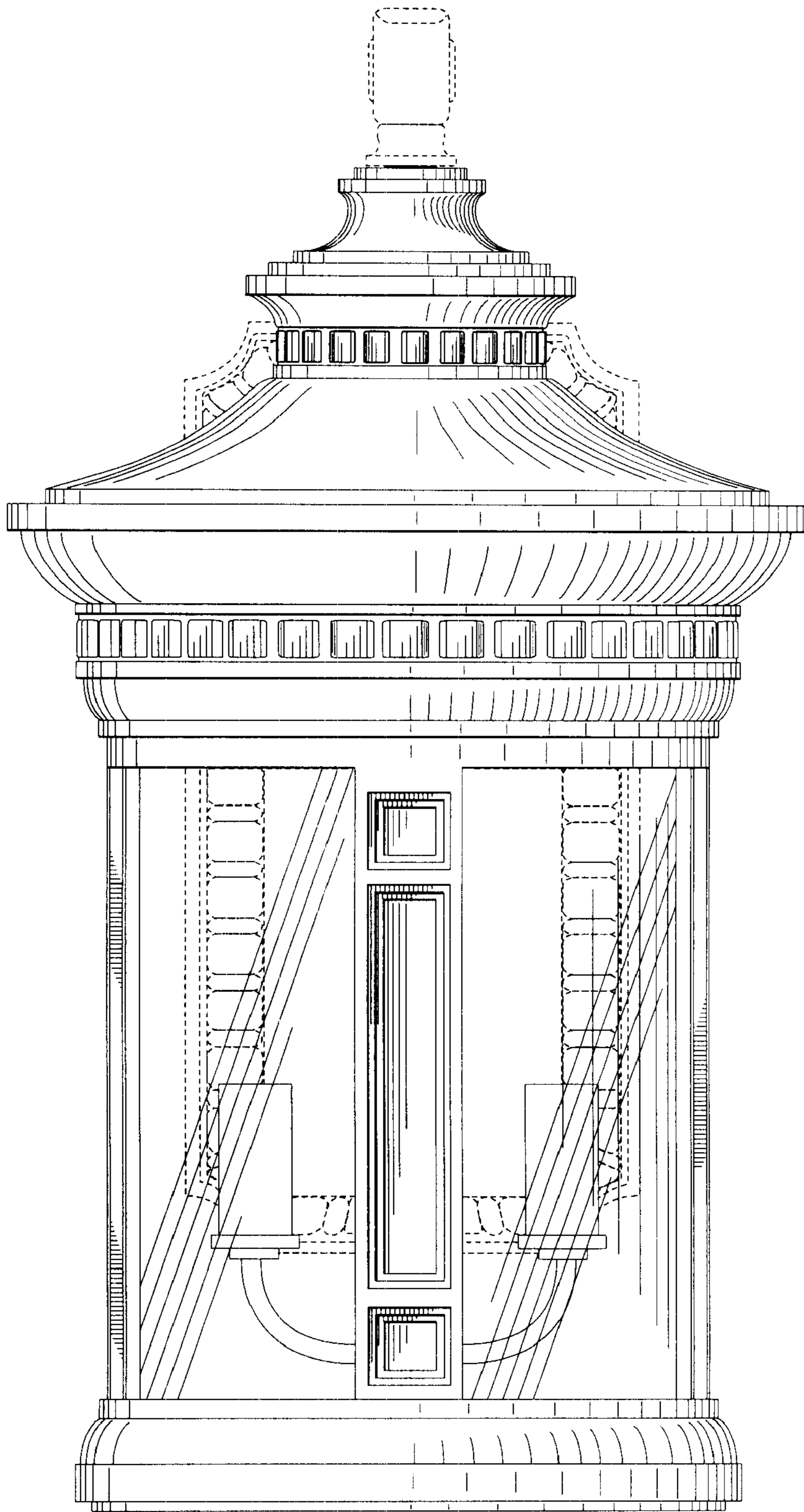

FIG. 3.

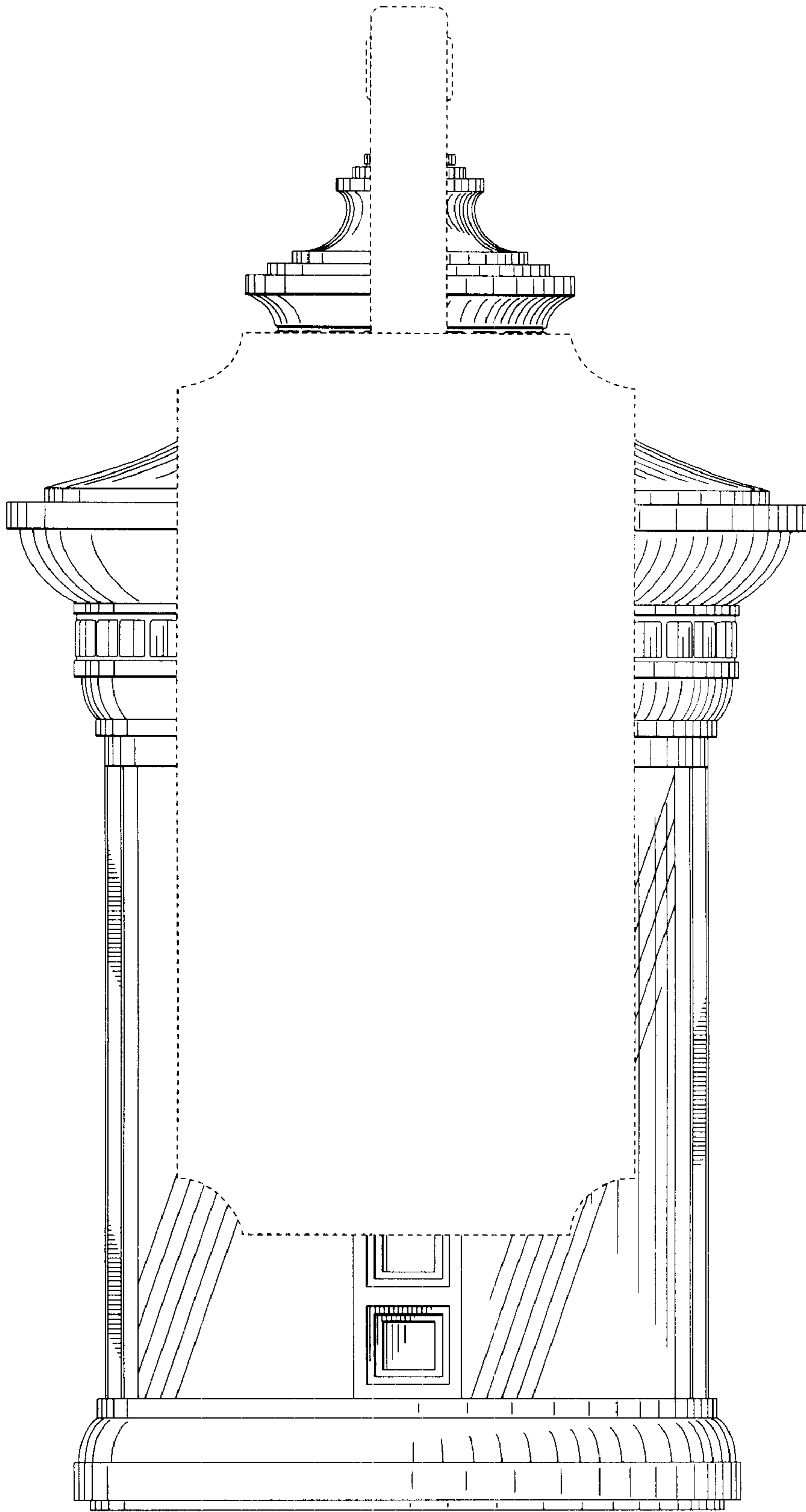

FIG. 4.

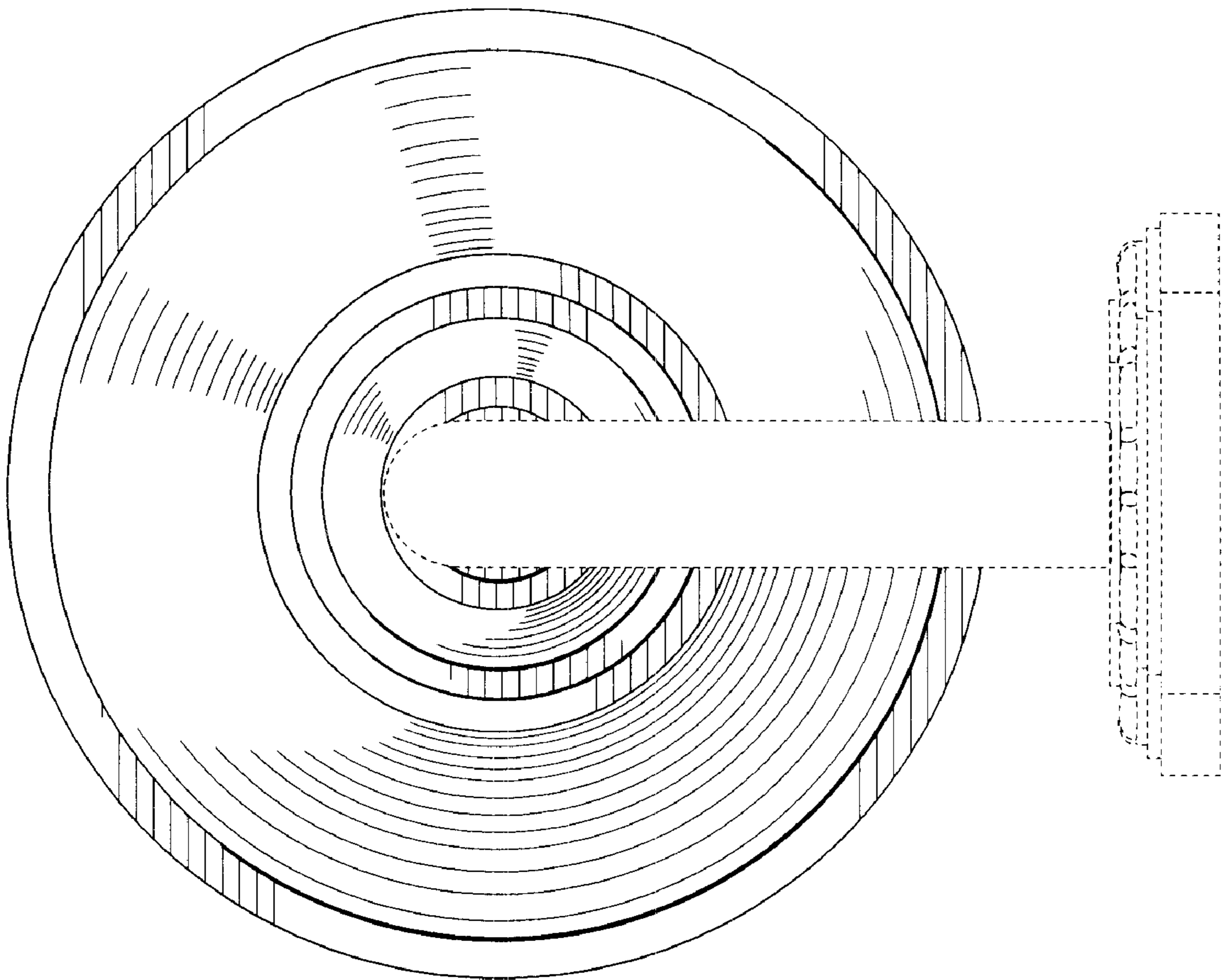

FIG. 5.

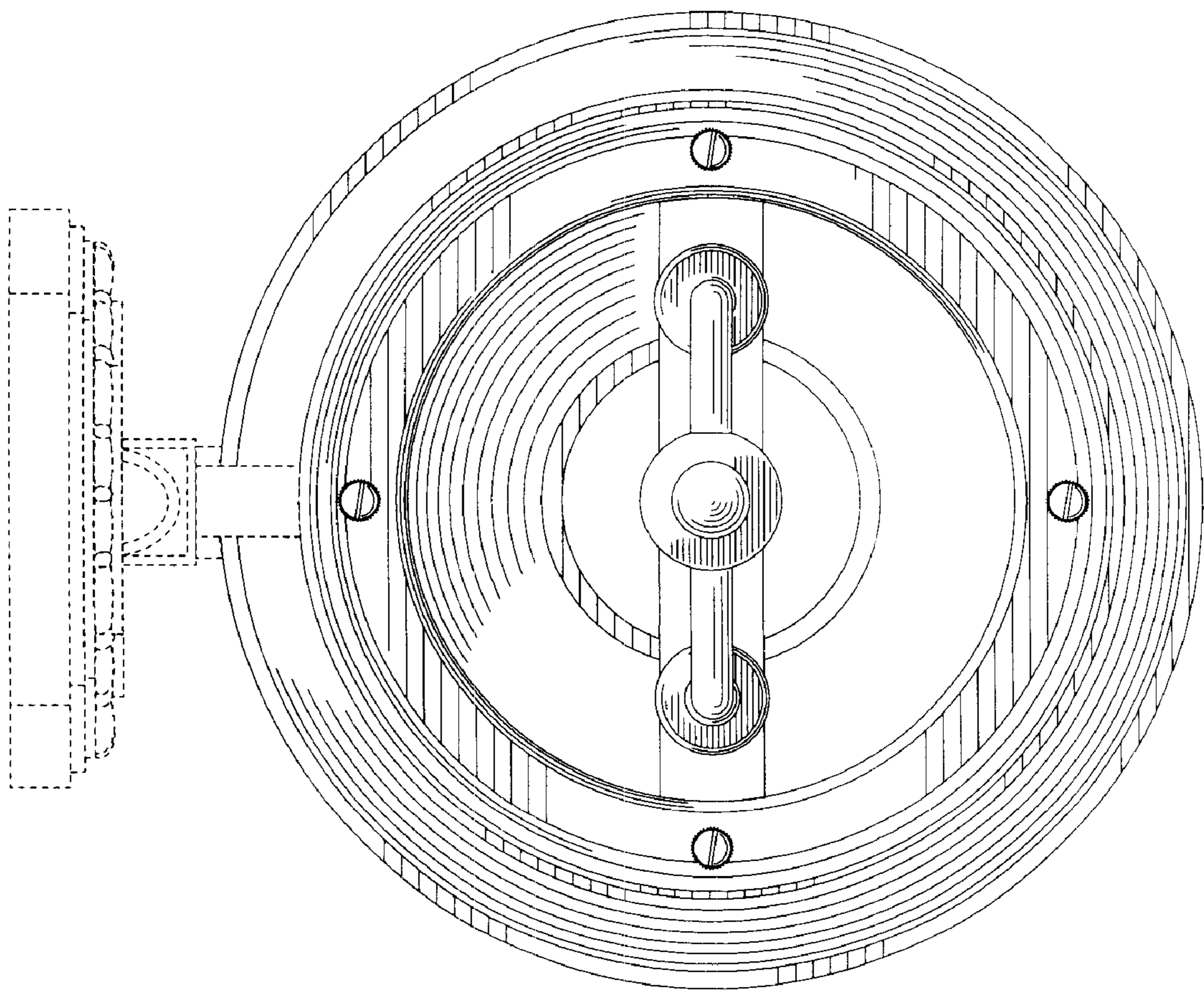

FIG. 6.