



US00D458700S

(12) **United States Design Patent**
Yancy

(10) **Patent No.:** **US D458,700 S**

(45) **Date of Patent:** **** Jun. 11, 2002**

(54) **NIGHT LIGHT**

D435,124 S * 12/2000 Yuen D26/26

(76) Inventor: **Ronald B. Yancy**, 2721 Old Orchard Rd., Lancaster, PA (US) 17601

* cited by examiner

Primary Examiner—Marcus A. Jackson

(**) Term: **14 Years**

(57) **CLAIM**

(21) Appl. No.: **29/146,894**

The ornamental design for a night light, as shown and described.

(22) Filed: **Jun. 30, 2001**

DESCRIPTION

(51) **LOC (7) Cl.** **26-04**

(52) **U.S. Cl.** **D26/26**

(58) **Field of Search** D26/26, 72, 80-92,
D26/118; 362/147, 226, 432

FIG. 1 is a front elevation view of the night light showing the design;

FIG. 2 is a rear elevation view thereof;

FIG. 3 is a top plan view thereof;

FIG. 4 is a bottom plan view thereof;

FIG. 5 is an left side elevation view thereof; and,

FIG. 6 is an right side elevation view thereof.

(56) **References Cited**

U.S. PATENT DOCUMENTS

D377,837 S * 2/1997 Hollinger D26/26

1 Claim, 2 Drawing Sheets

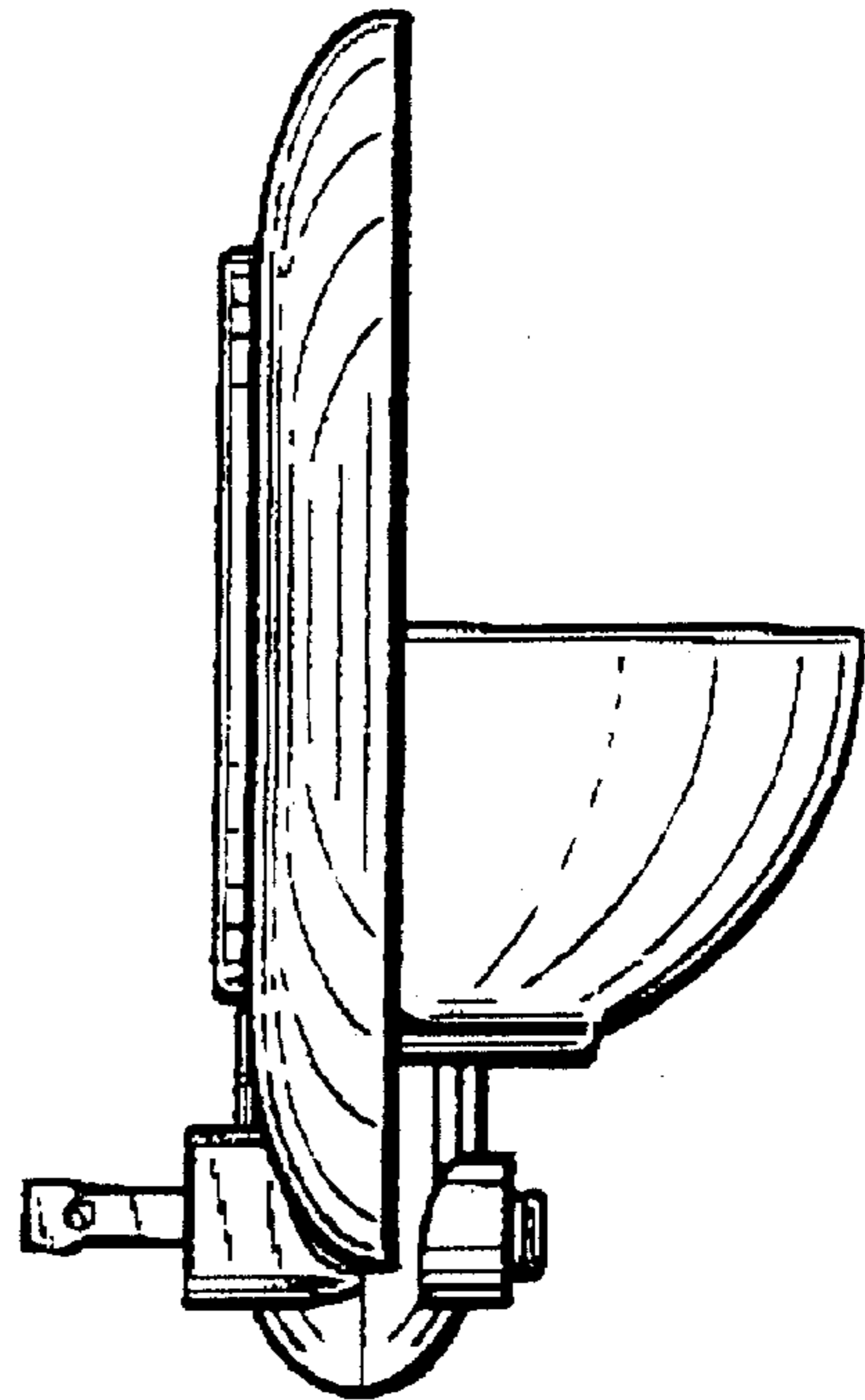
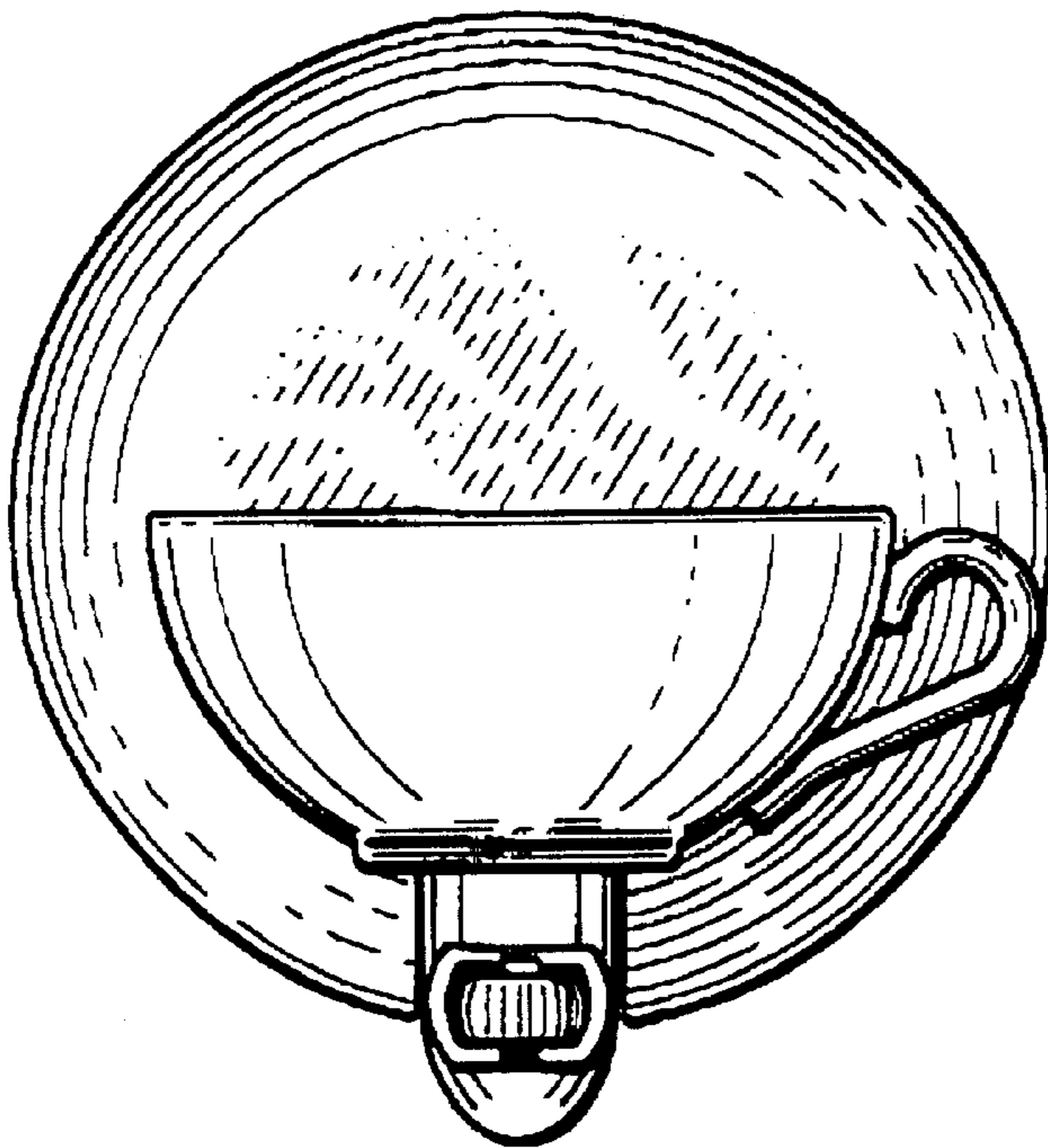

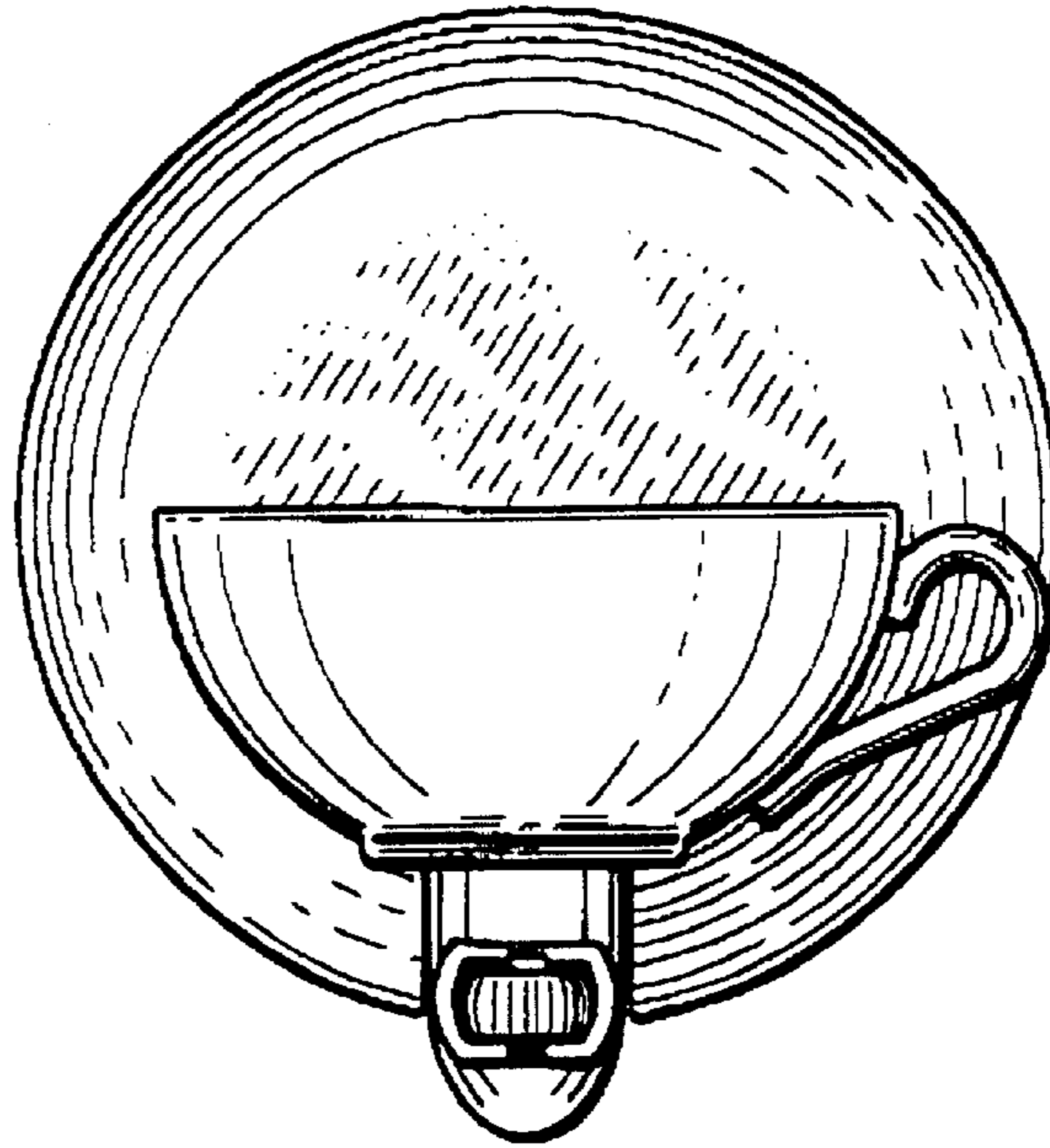

Fig. 1

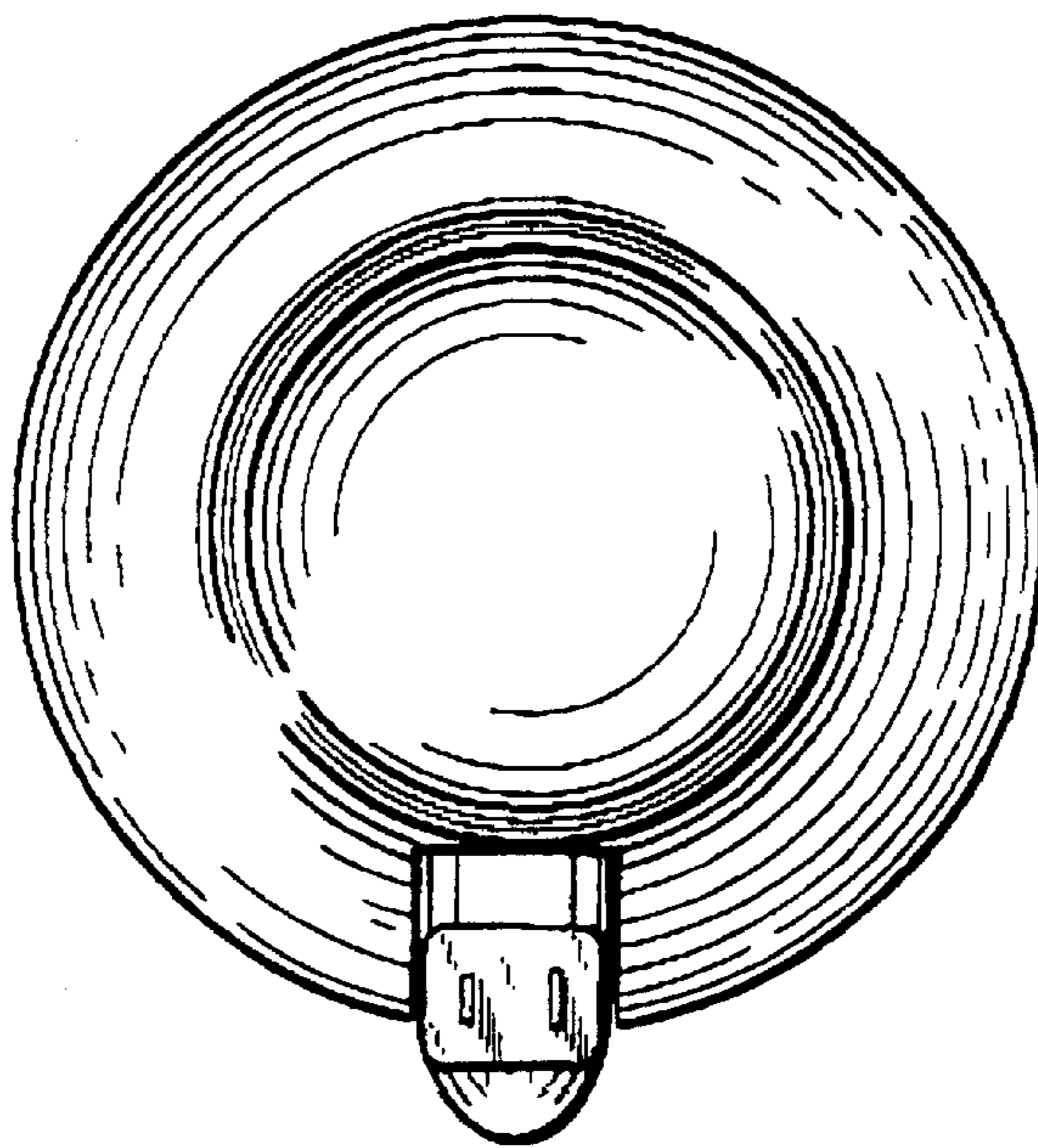

Fig. 2

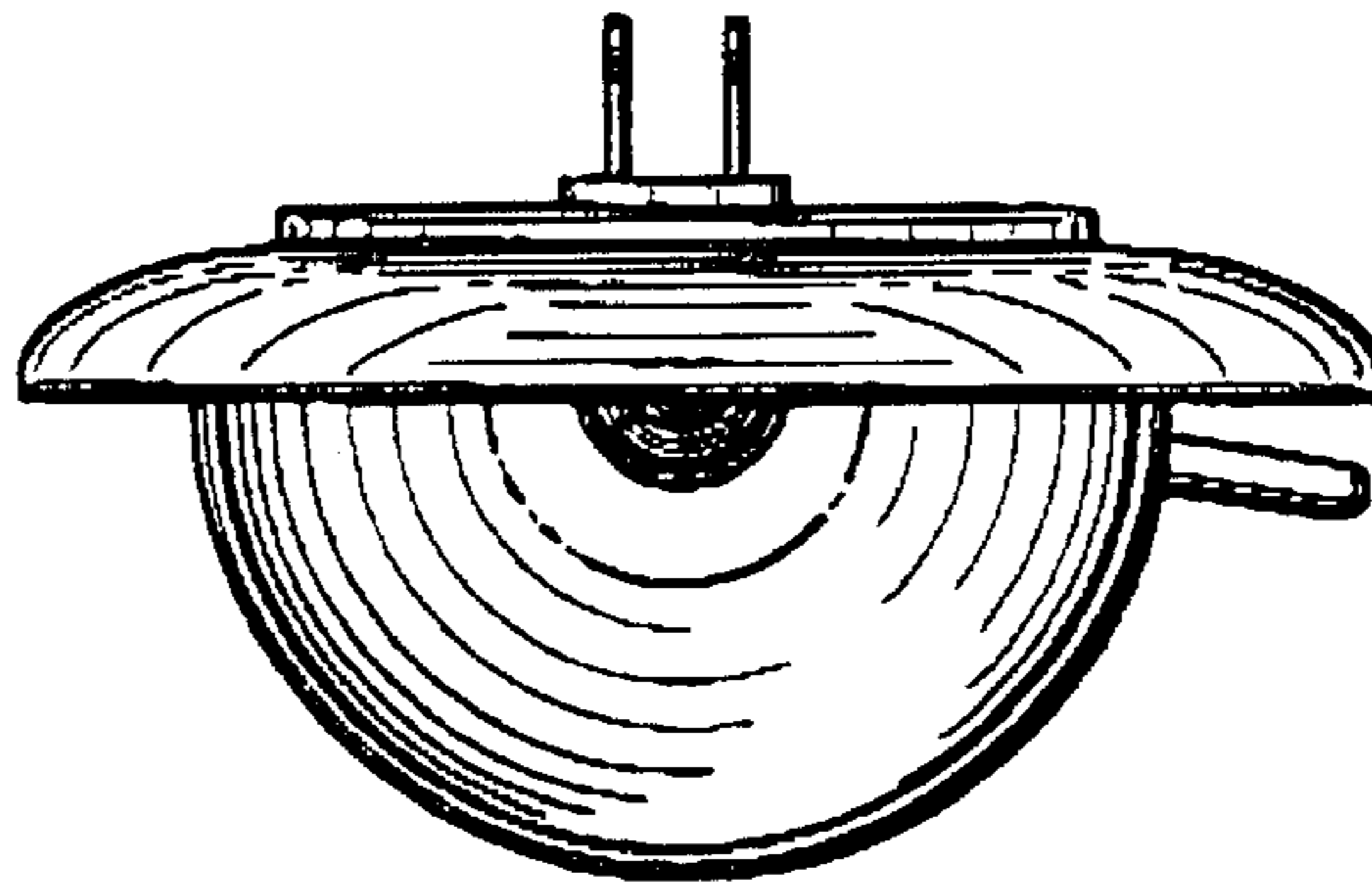

Fig. 3

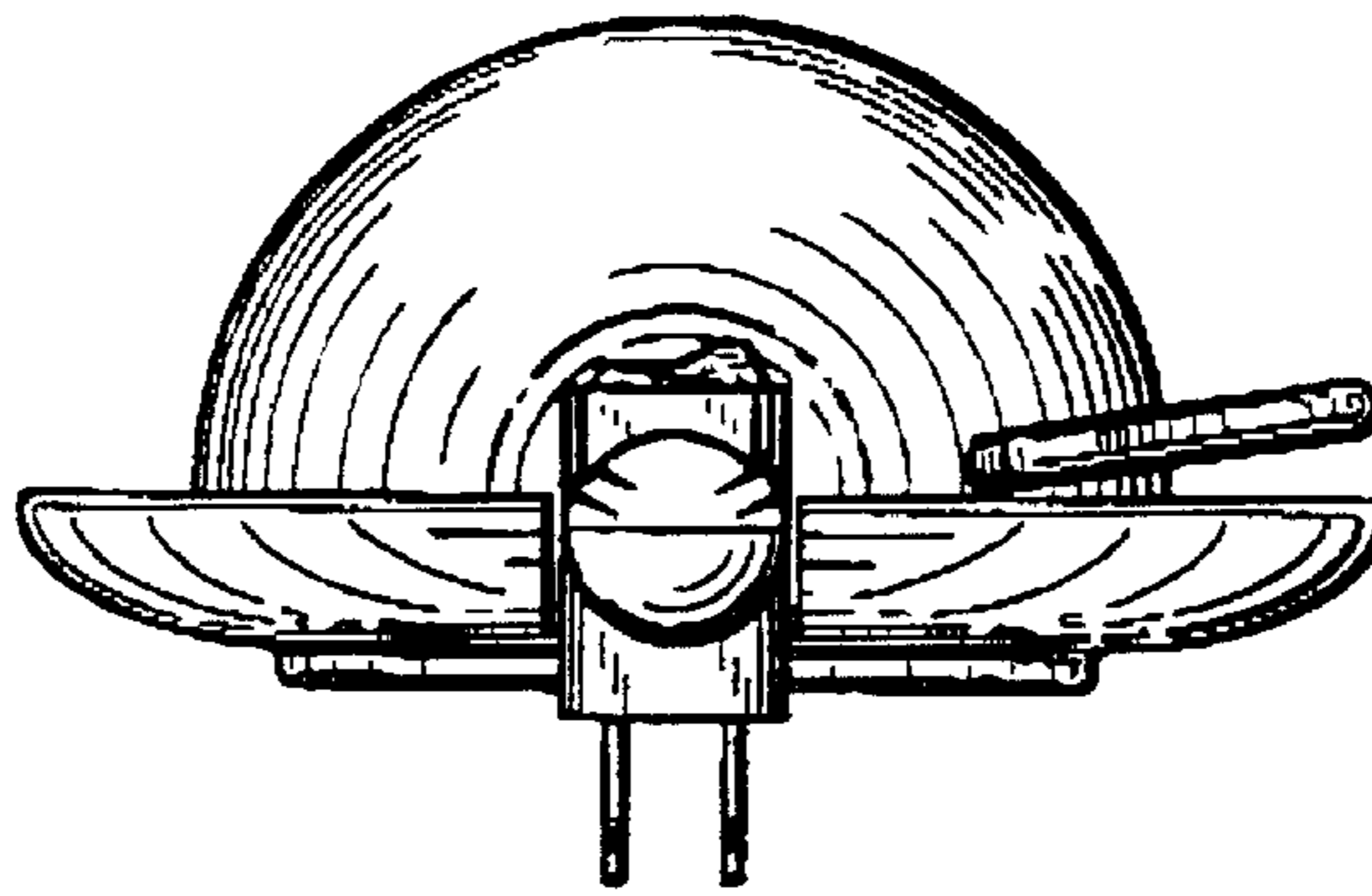

Fig. 4

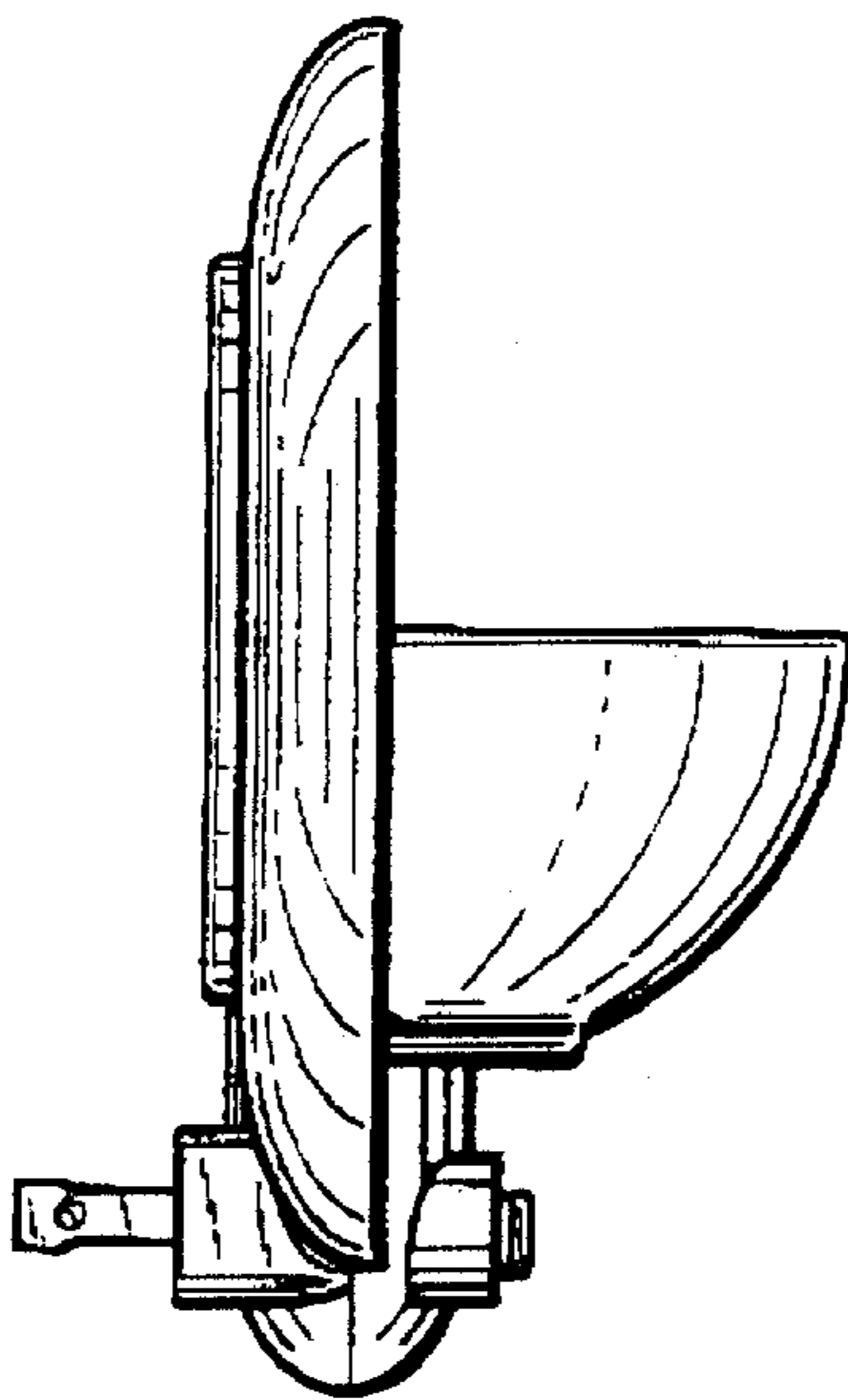

Fig. 5

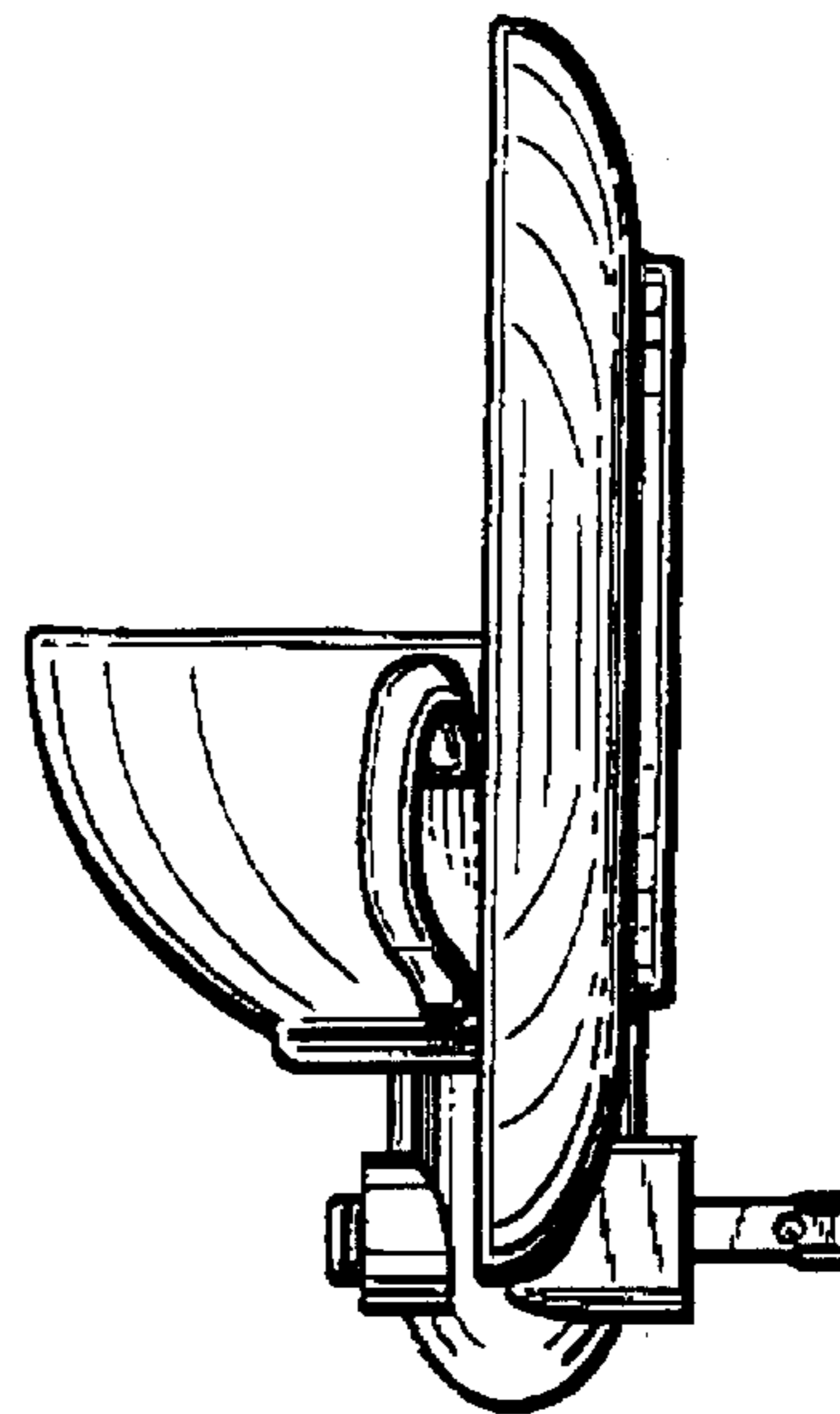

Fig. 6