



US00D458681S

(12) **United States Design Patent**
Sherlock et al.

(10) **Patent No.:** **US D458,681 S**
(45) **Date of Patent:** **** Jun. 11, 2002**

(54) **INTRAVAGINAL DEVICE**

(75) Inventors: **Roy Sherlock**, Swanton Morley;
George Lee Bulbrook, Billinford, both
of (GB)

(73) Assignee: **Neen Design Limited** (GB)

(**) Term: **14 Years**

(21) Appl. No.: **29/131,487**

(22) Filed: **Oct. 23, 2000**

(30) **Foreign Application Priority Data**

Apr. 26, 2000 (GB) 2092373

(51) **LOC (7) Cl.** **24-02**

(52) **U.S. Cl.** **D24/141; D24/133**

(58) **Field of Search** D24/133, 140,
D24/135, 188, 141; 600/6, 119, 193, 29,
30; 482/105, 148, 93

(56) **References Cited**

U.S. PATENT DOCUMENTS

- D272,945 S * 3/1984 Suhel et al. D24/214
- 4,554,909 A * 11/1985 Torres 600/6
- 4,574,791 A * 3/1986 Mitchener 600/38
- D291,918 S * 9/1987 Spits D24/141
- 5,213,557 A * 5/1993 Firth 485/105

- 5,865,715 A * 2/1999 Wallick 482/124
- 6,030,338 A * 2/2000 Benderev 600/30
- D421,497 S * 3/2000 Wattiez D24/141
- 6,068,581 A * 5/2000 Anderson 600/591
- 6,110,099 A * 8/2000 Benderev 600/30

* cited by examiner

Primary Examiner—Ian Simmons

(74) *Attorney, Agent, or Firm*—Shaftal and Associates, Ltd.

(57) **CLAIM**

The ornamental design for the intravaginal device, as shown and described.

DESCRIPTION

FIG. 1 is a perspective view of the intravaginal device showing a new ornamental design thereof;
 FIG. 2 is a left side view thereof, the right side view being a mirror image thereto;
 FIG. 3 is a plan view;
 FIG. 4 is a rear view thereof;
 FIG. 5 is a bottom view;
 FIG. 6 is a front view thereof;
 FIG. 7 is a cross-sectional view thereof taken along line 7—7 of FIG. 3; and,
 FIG. 8 is a cross-sectional view thereof taken along line 8—8 of FIG. 3.

1 Claim, 3 Drawing Sheets

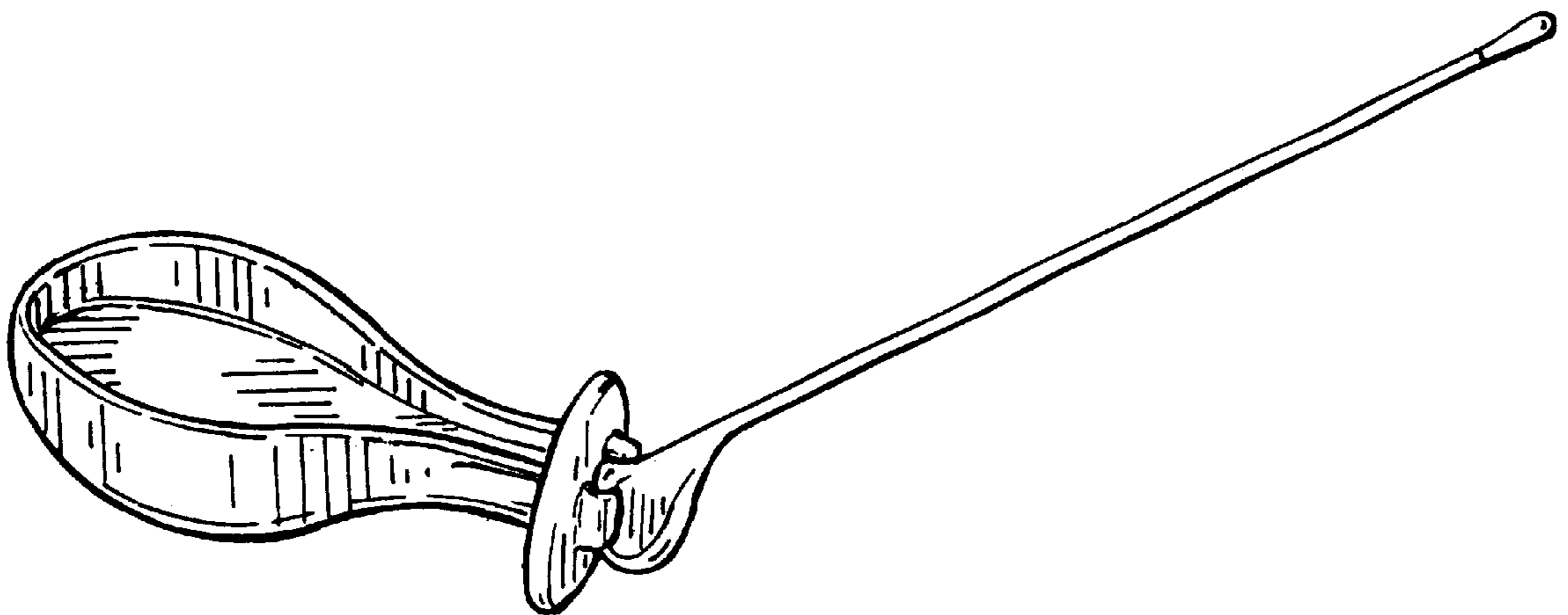

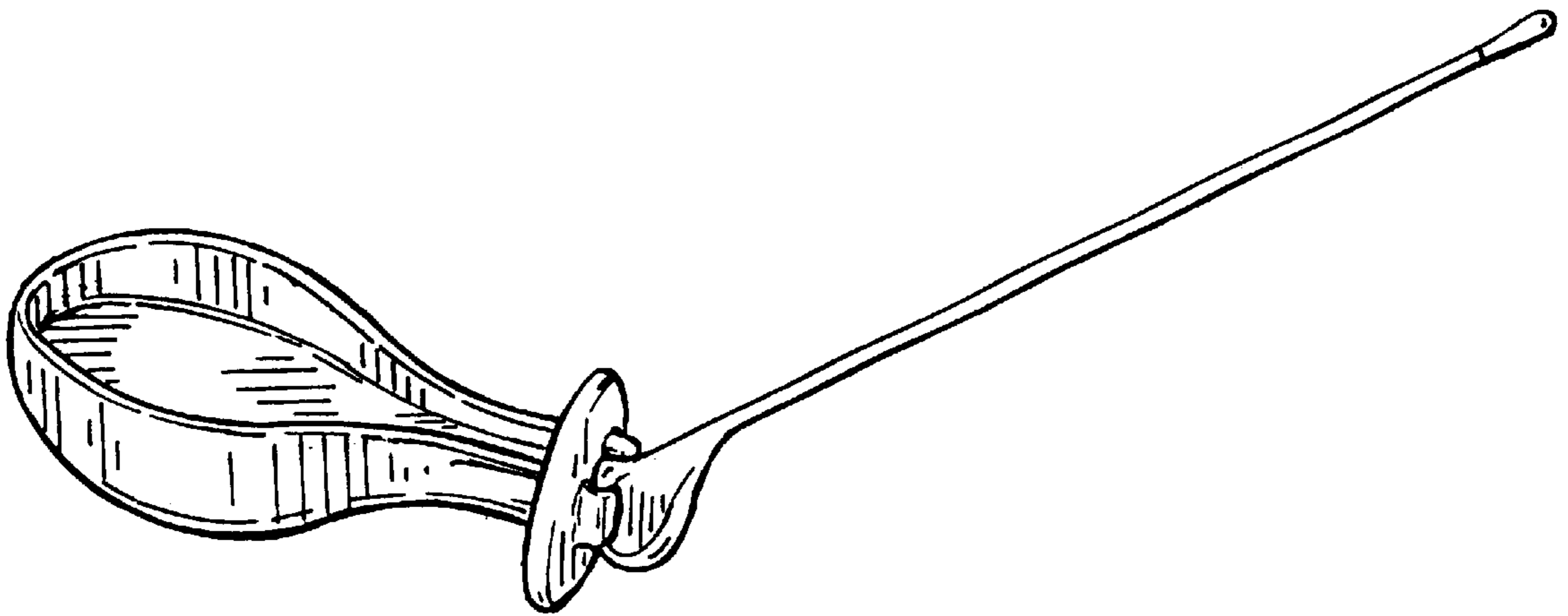

Fig. 1

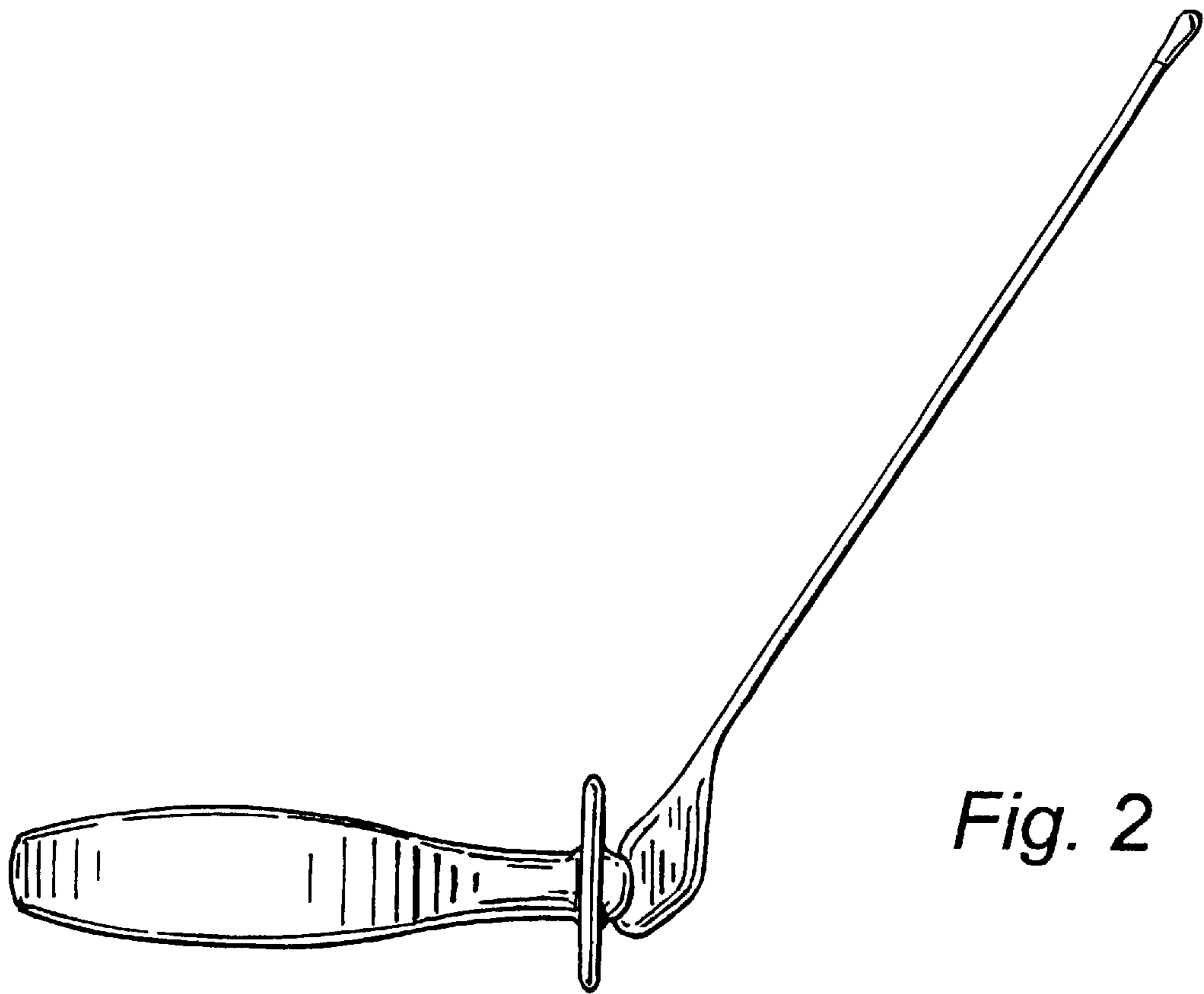

Fig. 2

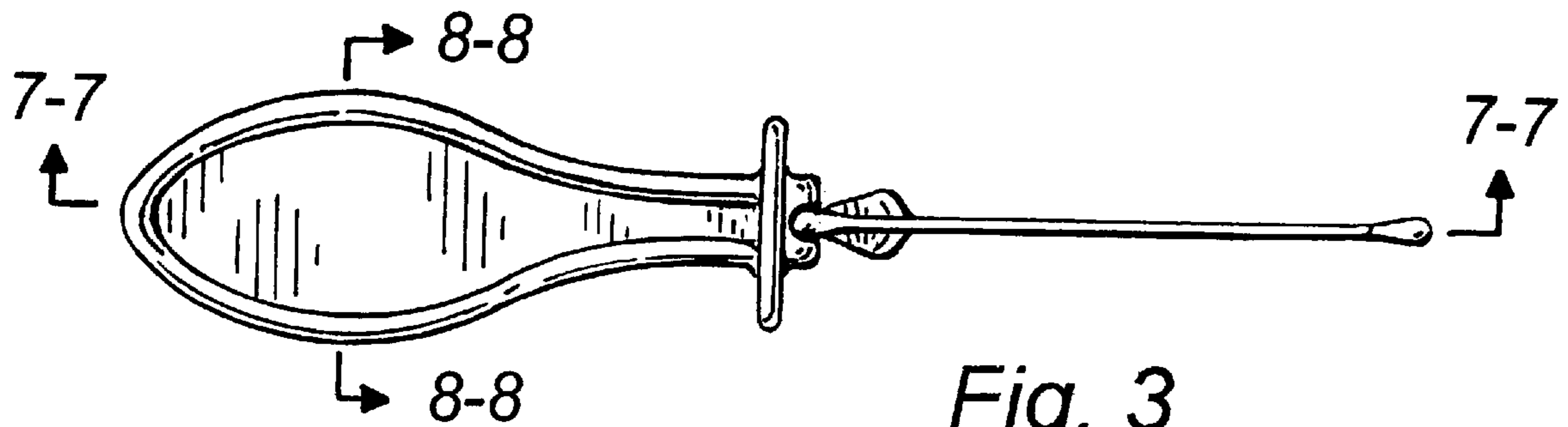

Fig. 3

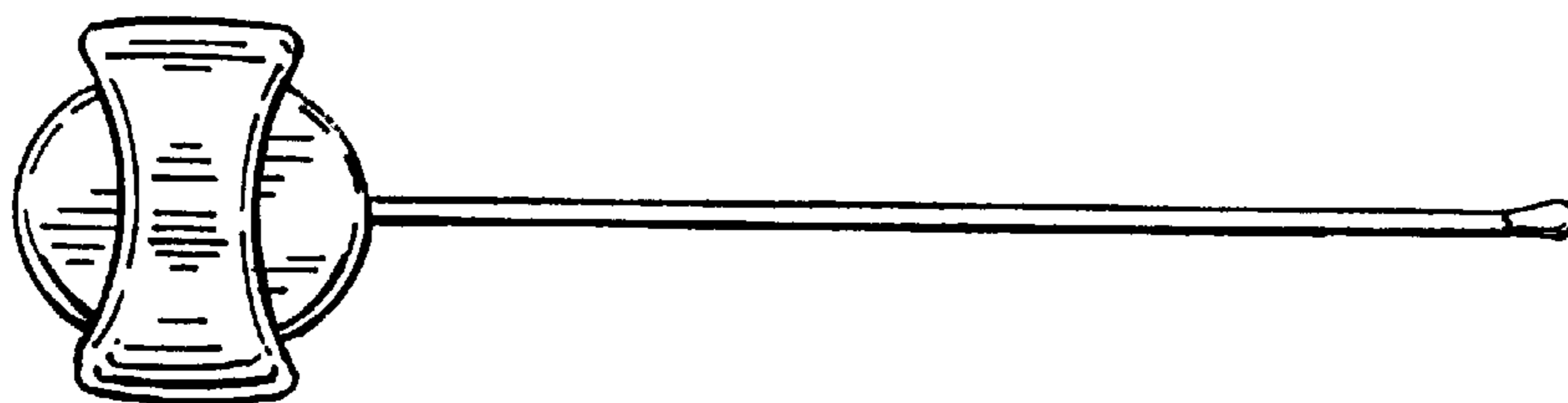

Fig. 4

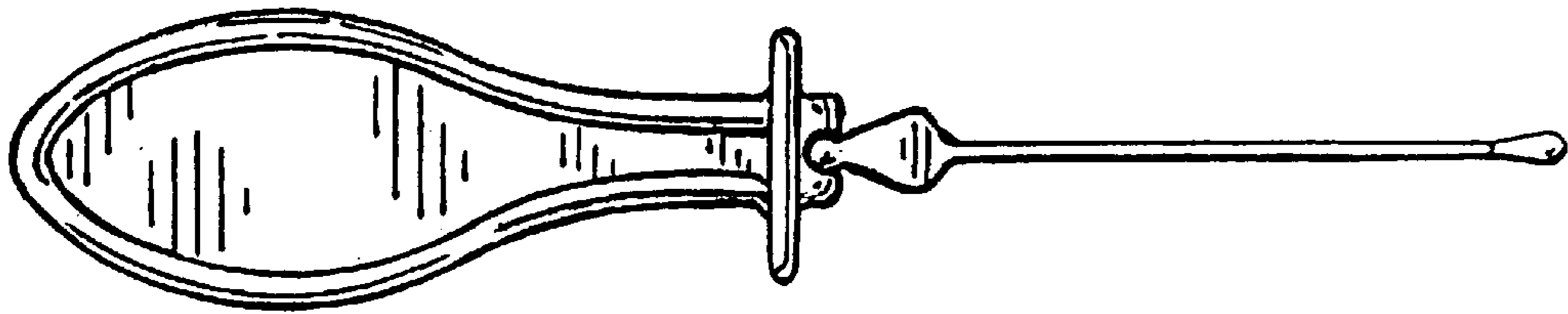

Fig. 5

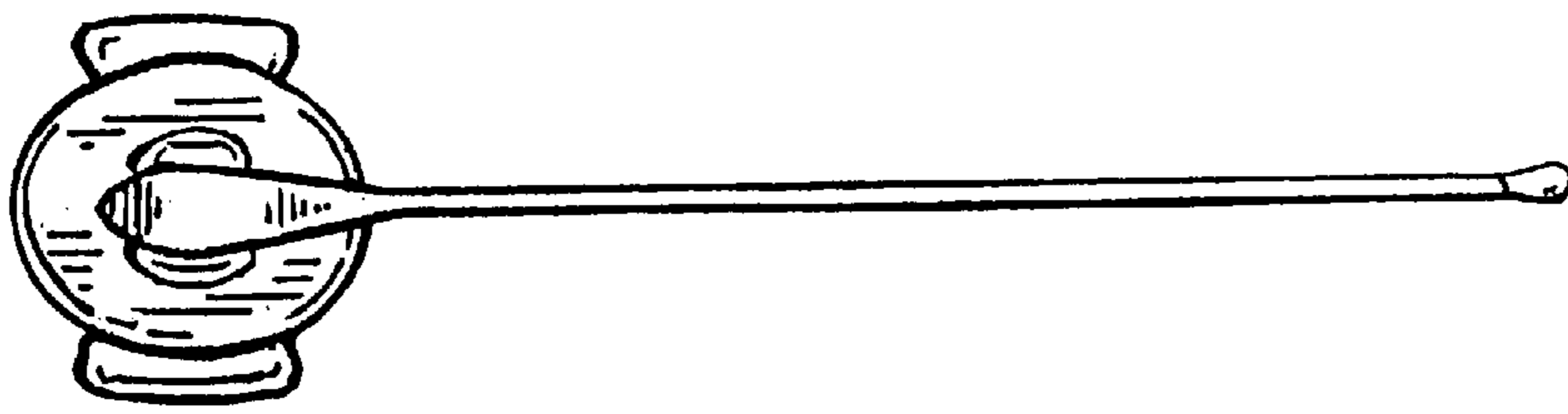

Fig. 6

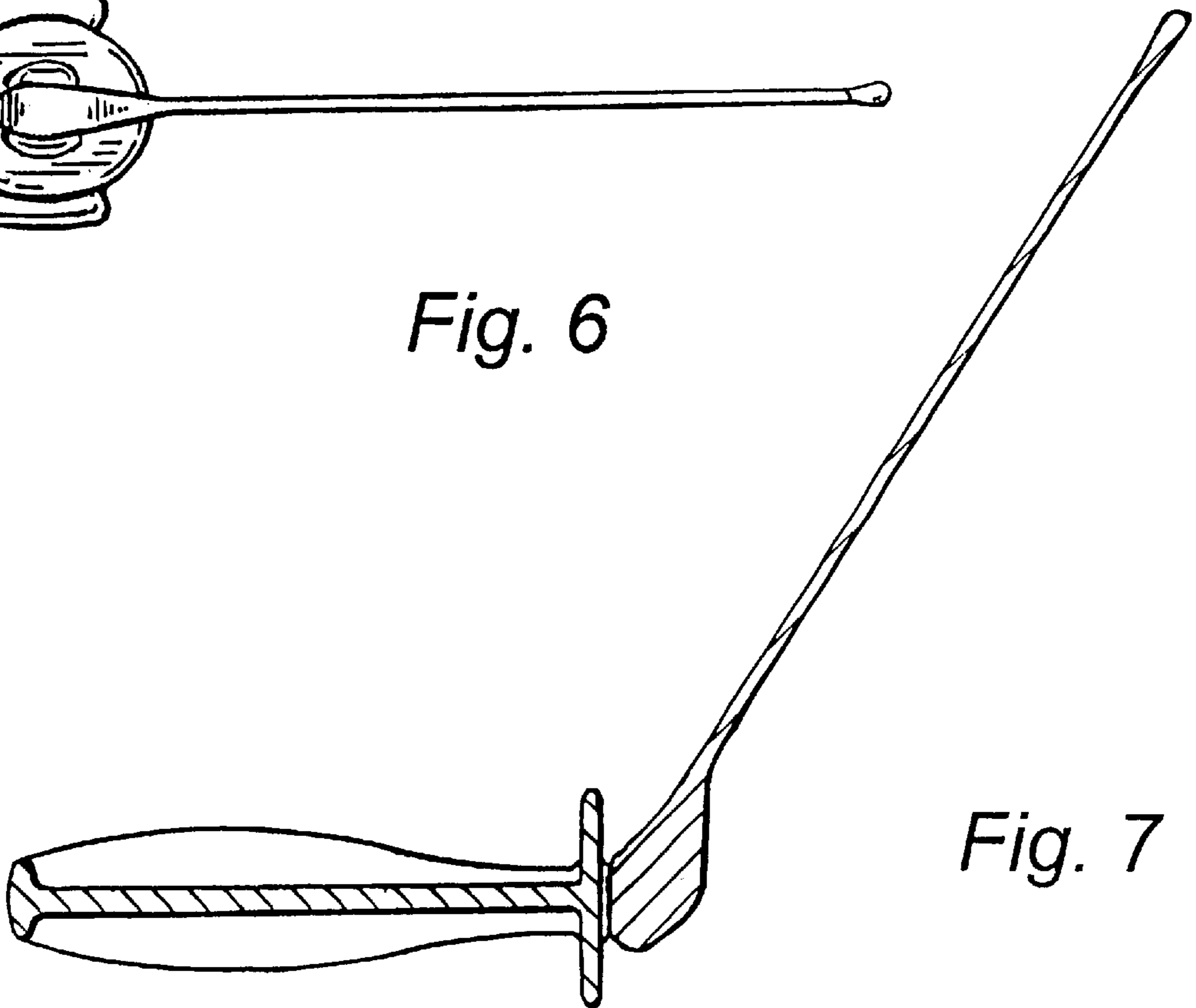

Fig. 7

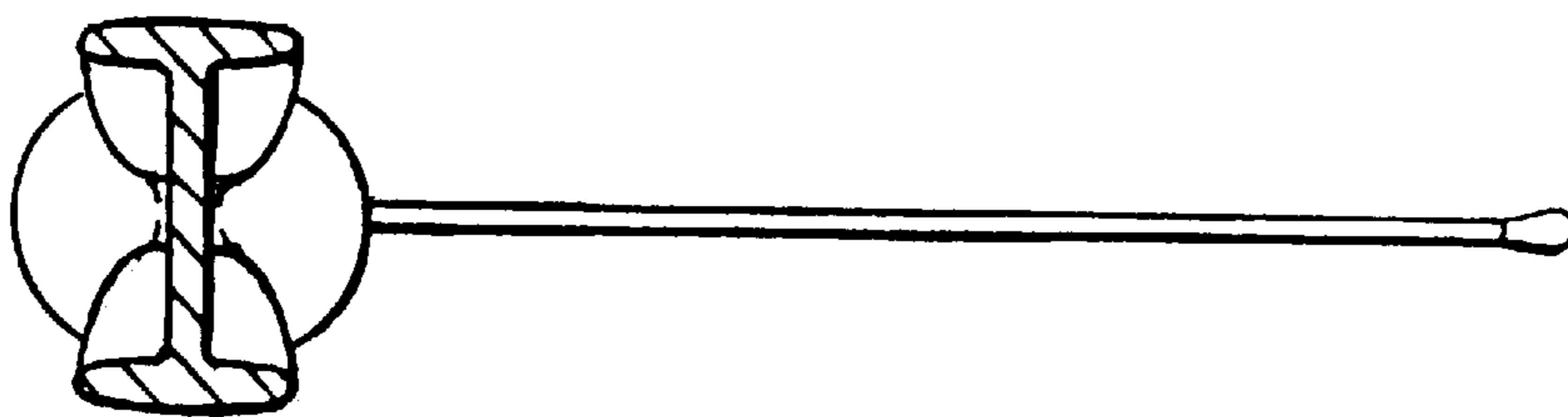

Fig. 8