



US00D458664S

(12) **United States Design Patent**
Wang

(10) **Patent No.:** **US D458,664 S**

(45) **Date of Patent:** **** Jun. 11, 2002**

(54) **SPRAY GUN HANDLE**

D441,424 S * 5/2001 Guo D23/226

(75) Inventor: **Gary Wang**, Ontario, CA (US)

* cited by examiner

(73) Assignee: **Aquastar Industries, Inc.**, Ontario, CA (US)

Primary Examiner—Robin V. Taylor

(74) *Attorney, Agent, or Firm*—Troxell Law Office PLLC

(**) Term: **14 Years**

(57) **CLAIM**

The ornamental design for the spray gun handle, as shown and described.

(21) Appl. No.: **29/139,258**

(22) Filed: **Mar. 28, 2001**

DESCRIPTION

(51) **LOC (7) Cl.** **23-01**

(52) **U.S. Cl.** **D23/226**

(58) **Field of Search** D23/213, 223,
D23/226; 239/525, 526, 527

FIG. 1 is a perspective view of a spray gun handle showing my new design;

FIG. 2 is a front view thereof;

FIG. 3 is a rear view thereof;

FIG. 4 is a left side view thereof;

FIG. 5 is a right side view thereof;

FIG. 6 is a top view thereof; and,

FIG. 7 is a bottom view thereof.

(56) **References Cited**

U.S. PATENT DOCUMENTS

D376,839 S * 12/1996 Hung D23/226

D394,491 S * 5/1998 Guo D23/226

1 Claim, 4 Drawing Sheets

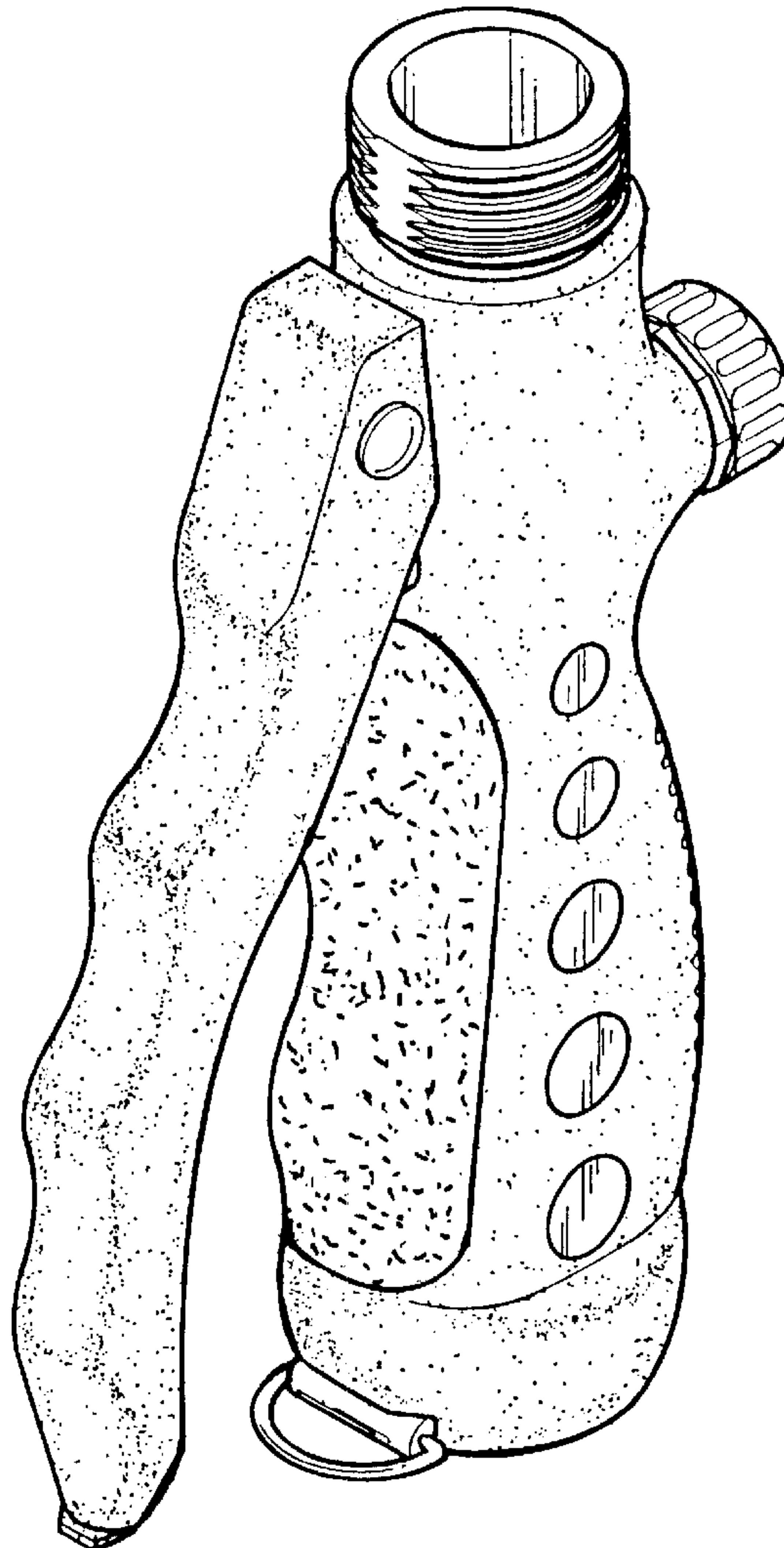

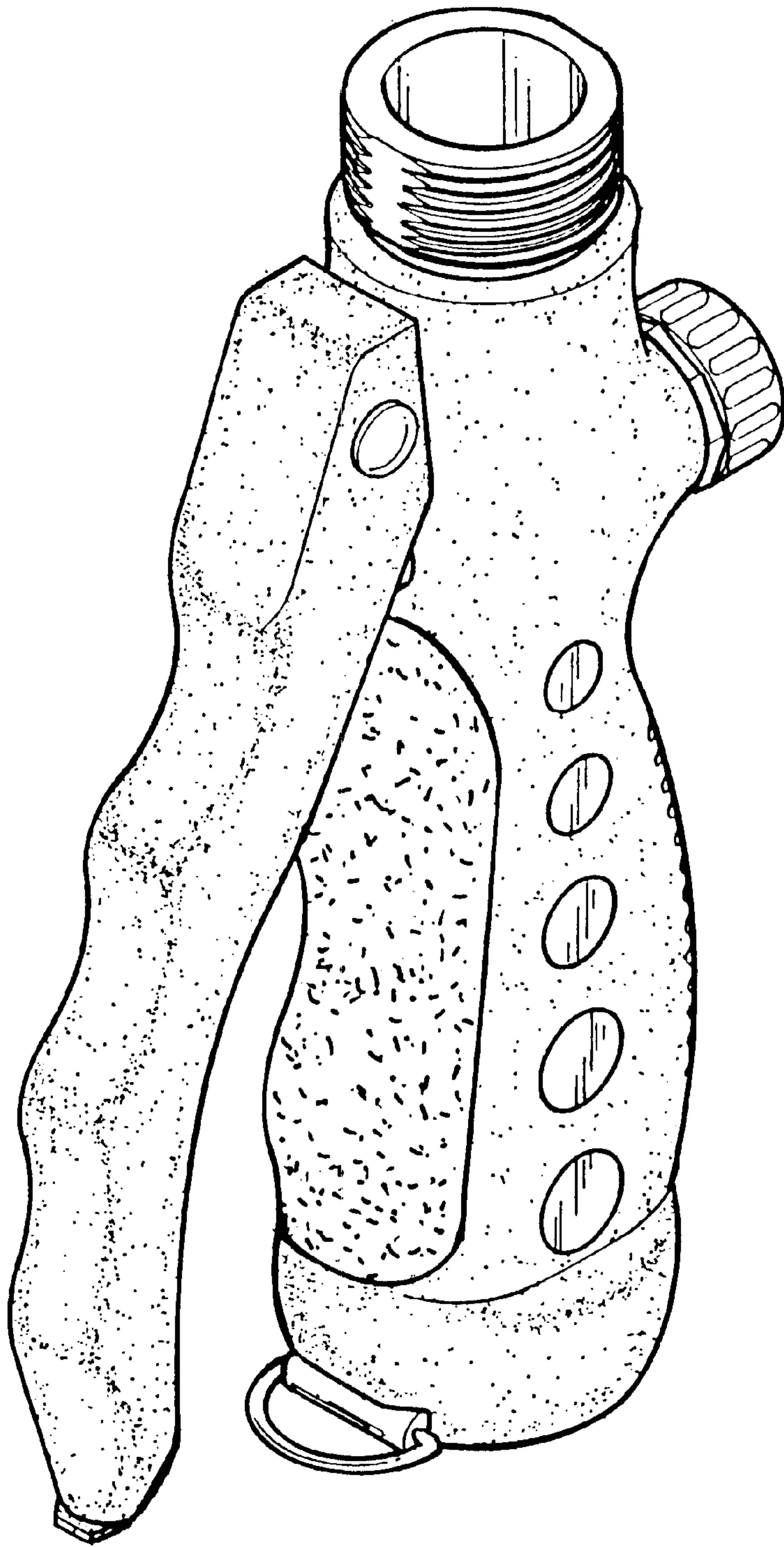

FIG. 1

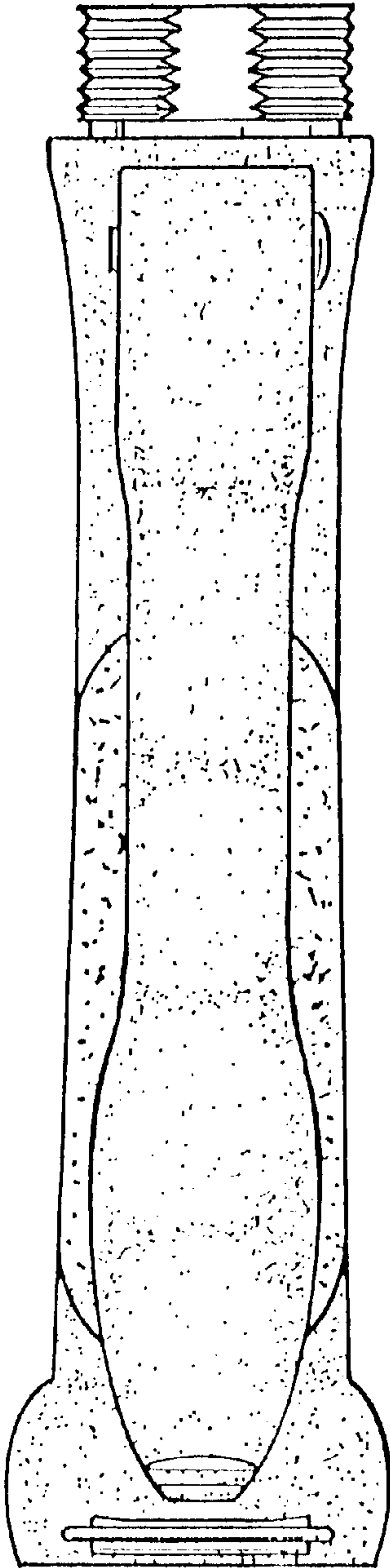

FIG. 2

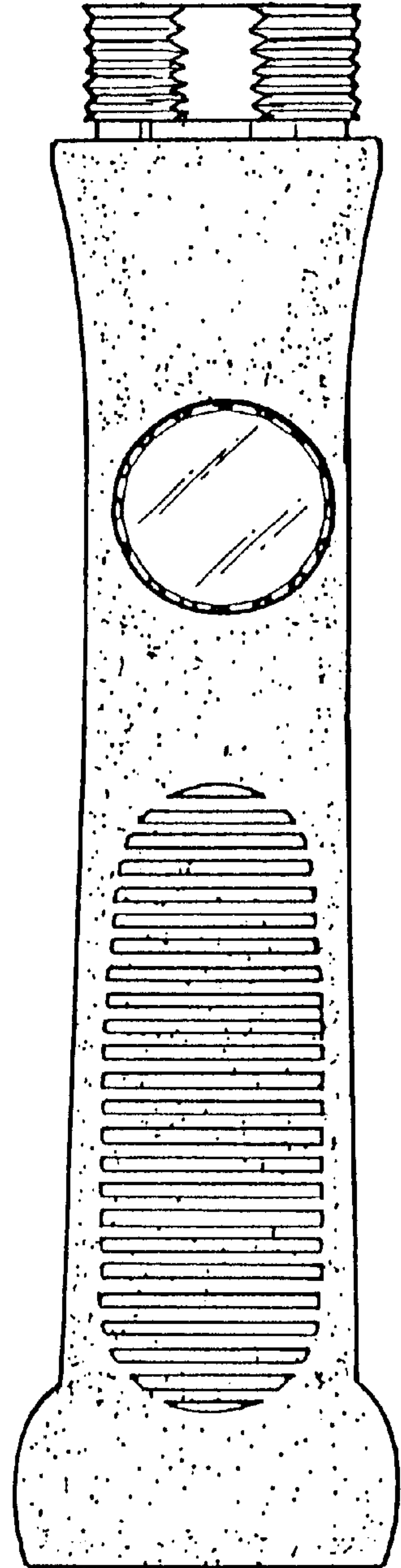

FIG. 3

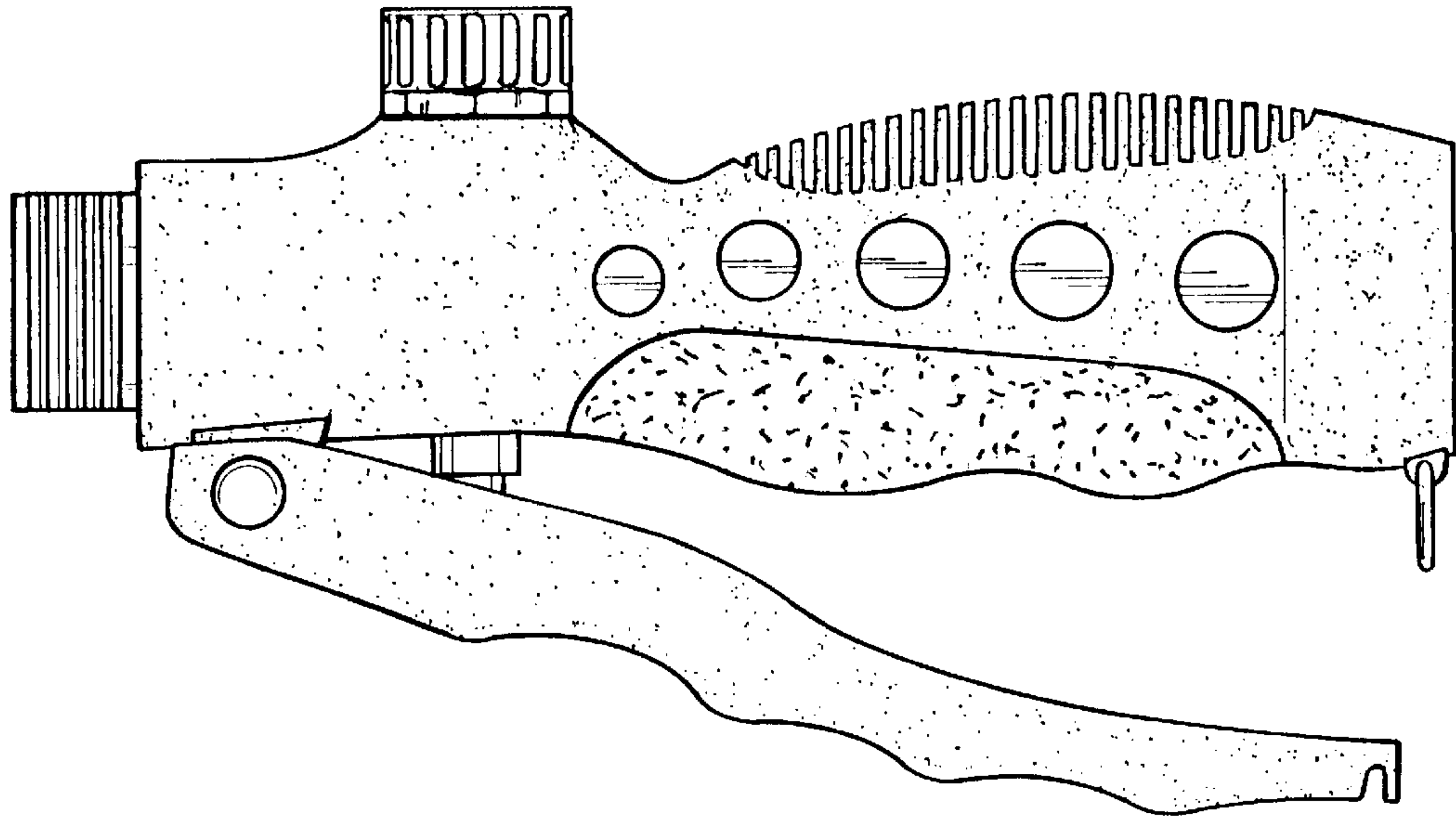

FIG. 5

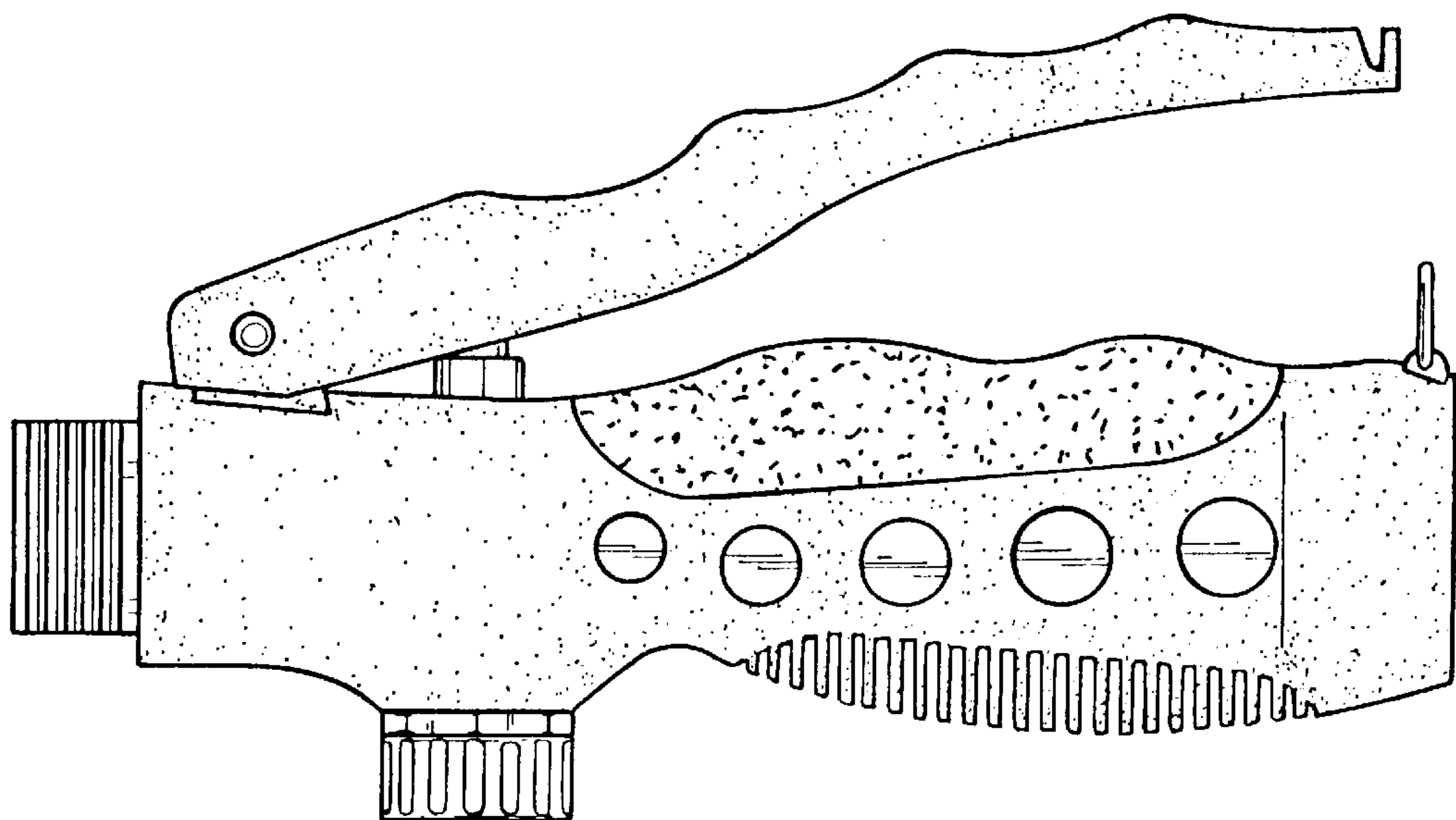

FIG. 4

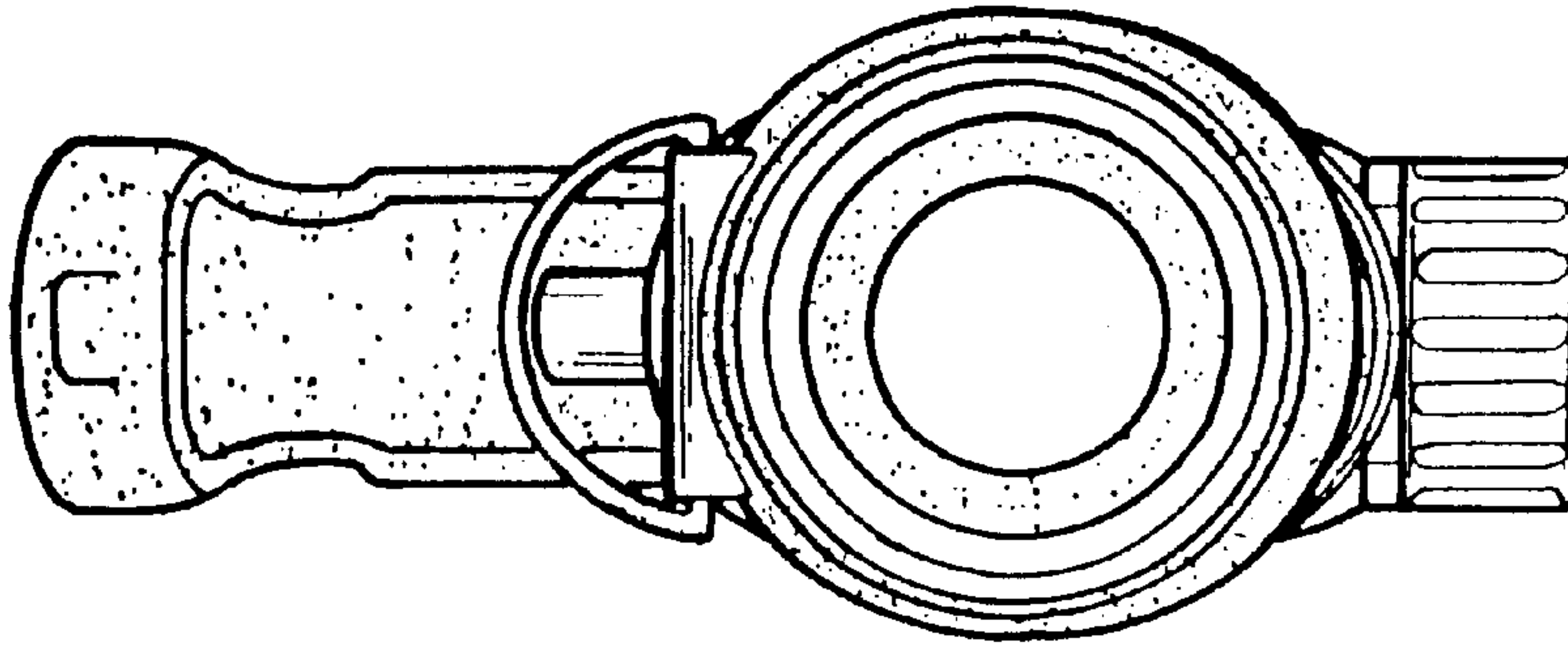

FIG. 7

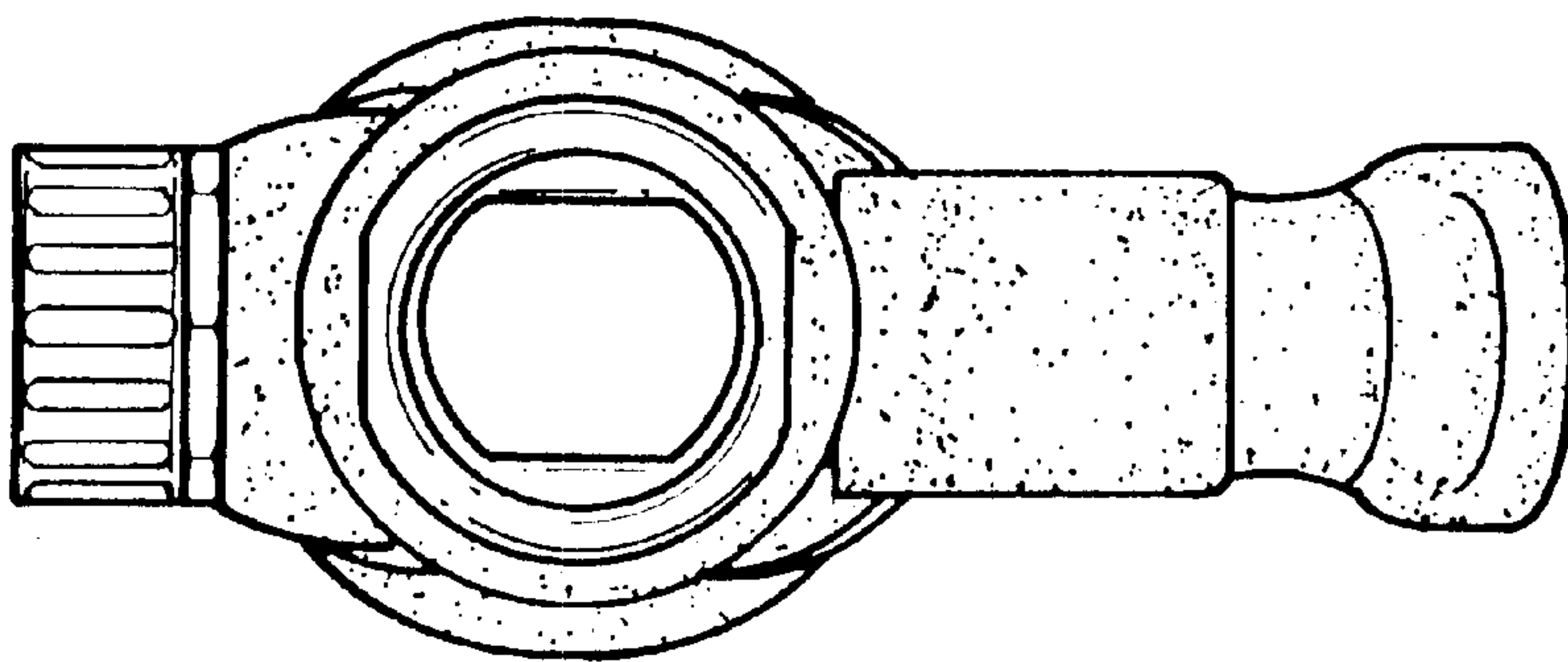

FIG. 6