



US00D458345S

(12) **United States Design Patent**
Gottwald

(10) **Patent No.:** **US D458,345 S**

(45) **Date of Patent:** **** Jun. 4, 2002**

(54) **FAUCET HANDLE**

(75) **Inventor:** **Adolf Gottwald, Iserlohn (DE)**

(73) **Assignee:** **Friedrich Grohe AG & Co. KG.,
Hemer (DE)**

(**) **Term:** **14 Years**

(21) **Appl. No.:** **29/141,945**

(22) **Filed:** **May 16, 2001**

(30) **Foreign Application Priority Data**

Dec. 6, 2000 (DE) 4 00 11 368

(51) **LOC (7) Cl.** **23-01**

(52) **U.S. Cl.** **D23/252**

(58) **Field of Search** D23/238-245,
D23/249-257; D8/300-310, 350-354; 4/675-678;
16/110 R-121; 137/801

(56) **References Cited**

U.S. PATENT DOCUMENTS

D390,922 S * 2/1998 Oswaks et al. D23/252

D406,322 S * 3/1999 Pitsch D23/252

D430,651 S * 9/2000 Fiegl et al. D23/252

D442,264 S * 5/2001 Mullenmeister D23/252

* cited by examiner

Primary Examiner—Louis S. Zarfaz

Assistant Examiner—Gregory Andoll

(74) *Attorney, Agent, or Firm*—Herbert Dubno

(57) **CLAIM**

The ornamental design for a faucet handle, as shown and described.

DESCRIPTION

FIG. 1 is a top, front, left-side perspective view of a faucet handle showing my new design;

FIG. 2 is a front elevational view thereof;

FIG. 3 is a rear elevational view thereof;

FIG. 4 is a top plan view thereof;

FIG. 5 is a left side elevational view thereof, the right side elevational view being mirror symmetrical thereto; and,

FIG. 6 is a bottom plan view thereof.

1 Claim, 2 Drawing Sheets

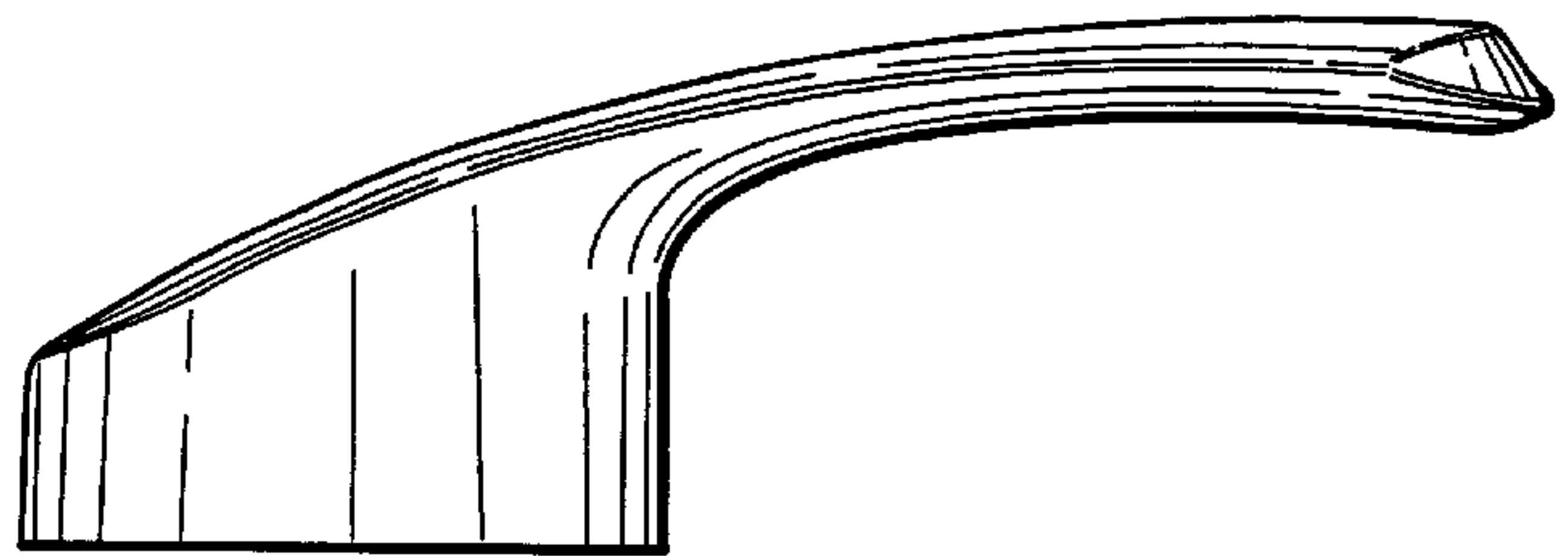
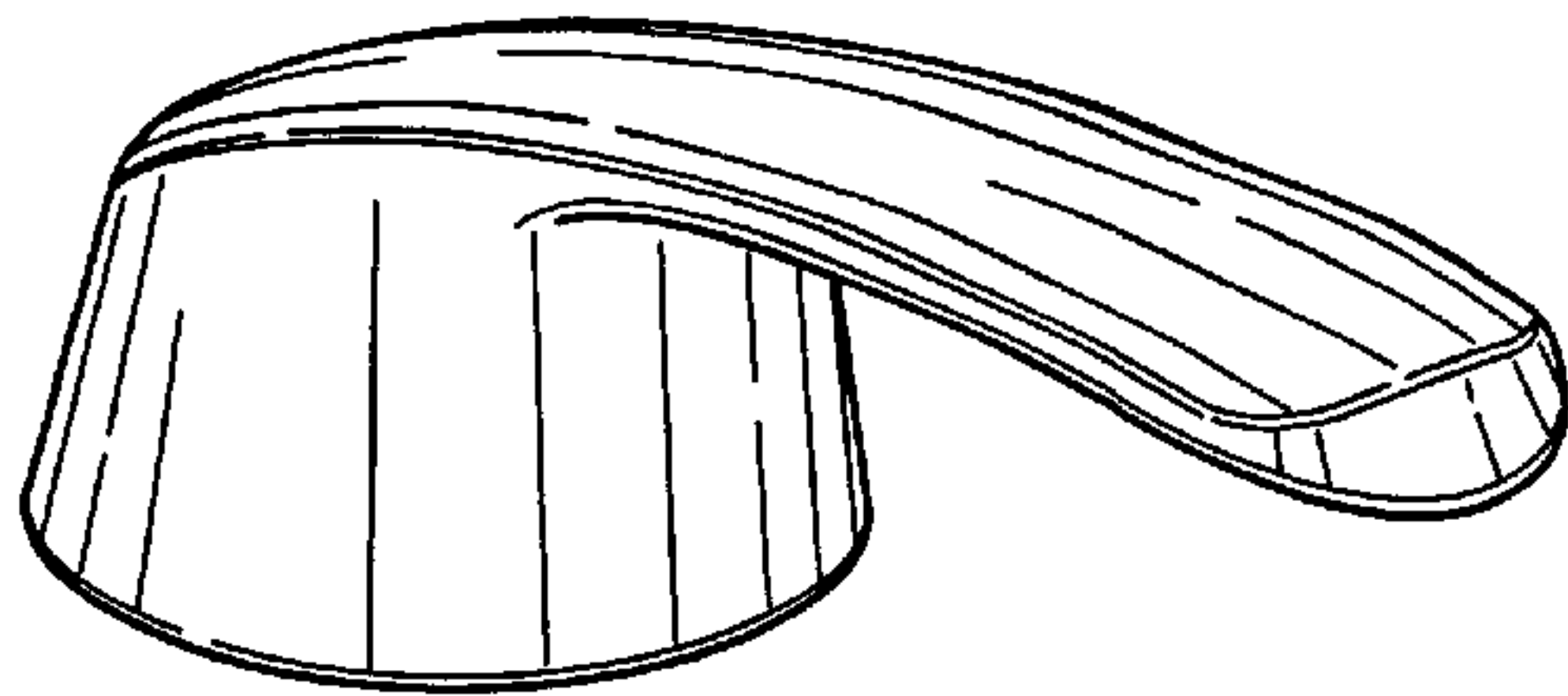

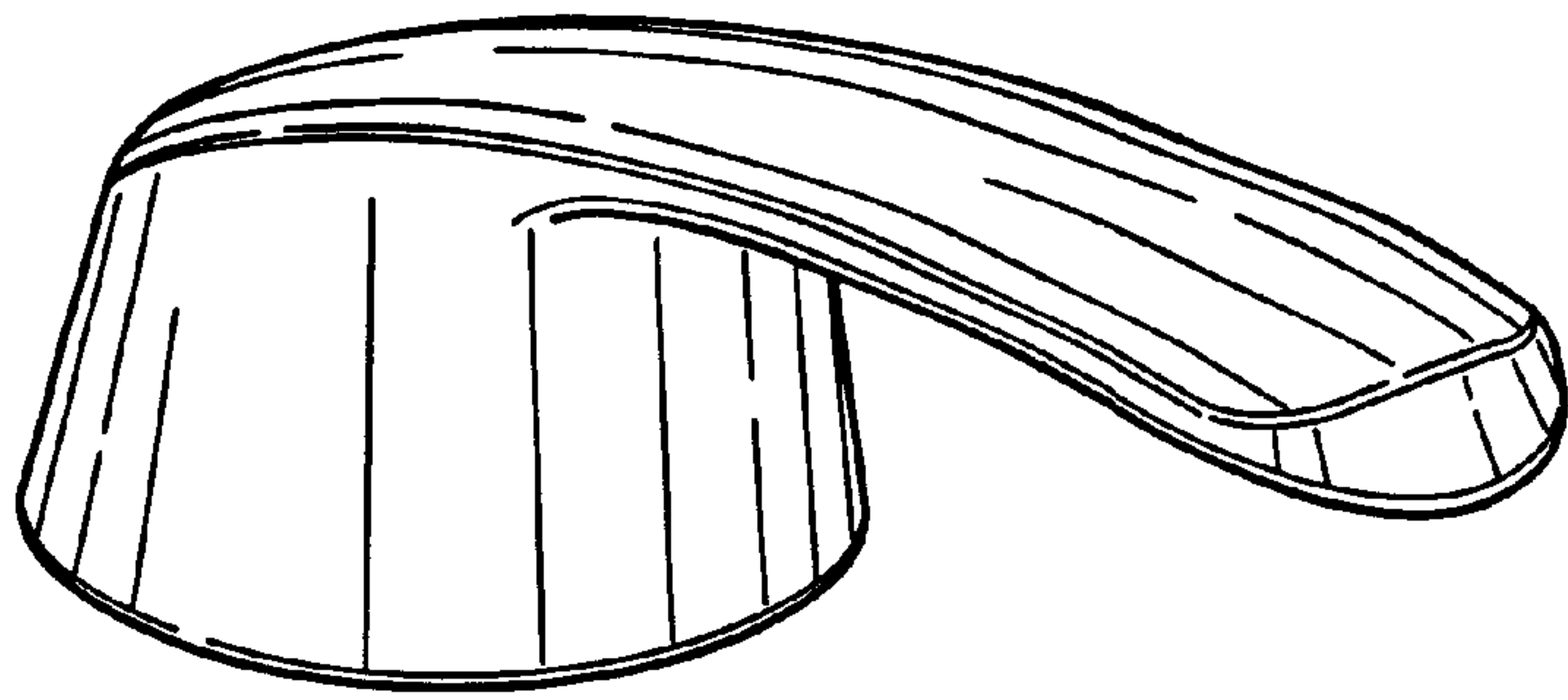

FIG. 1

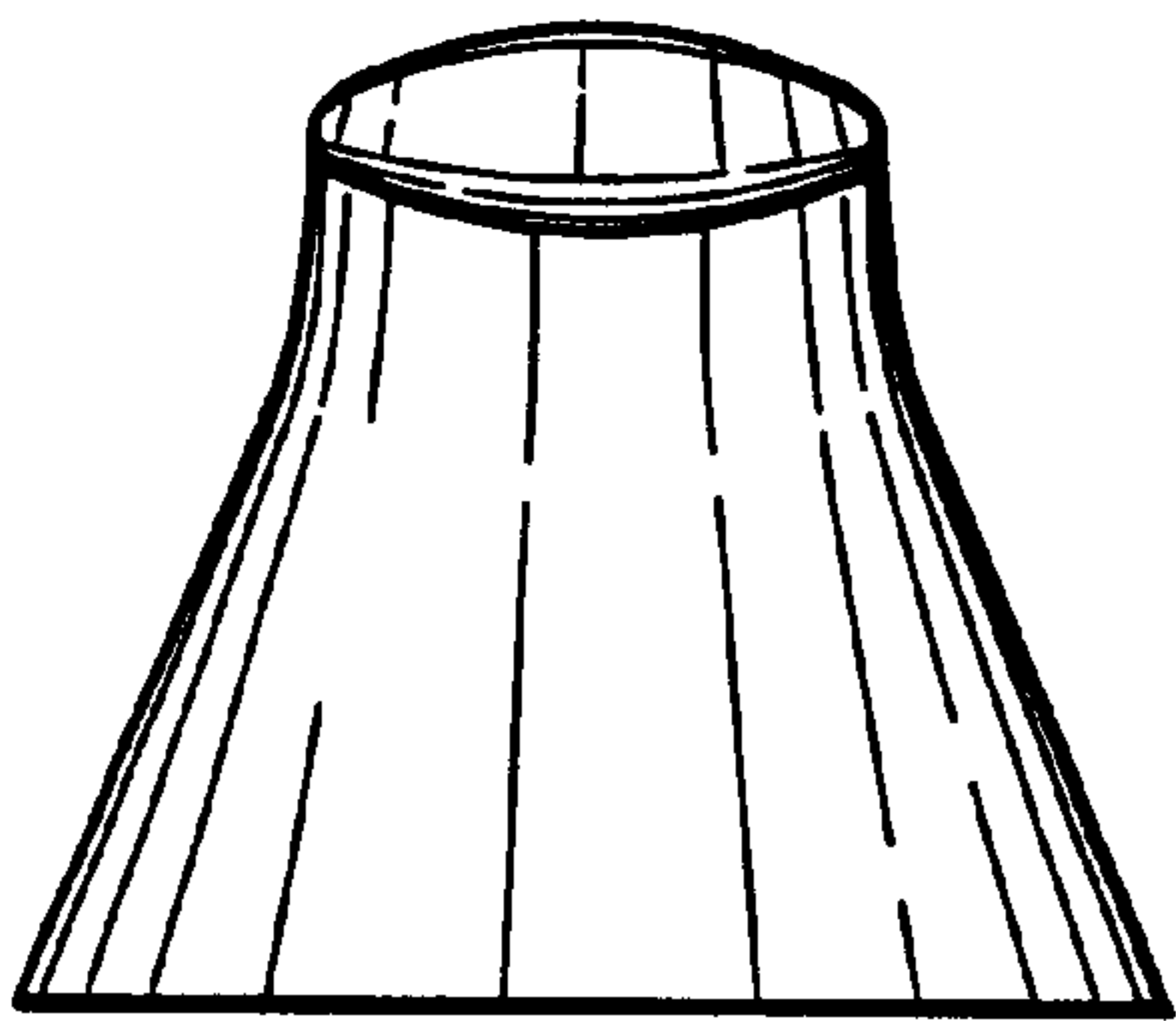

FIG. 2

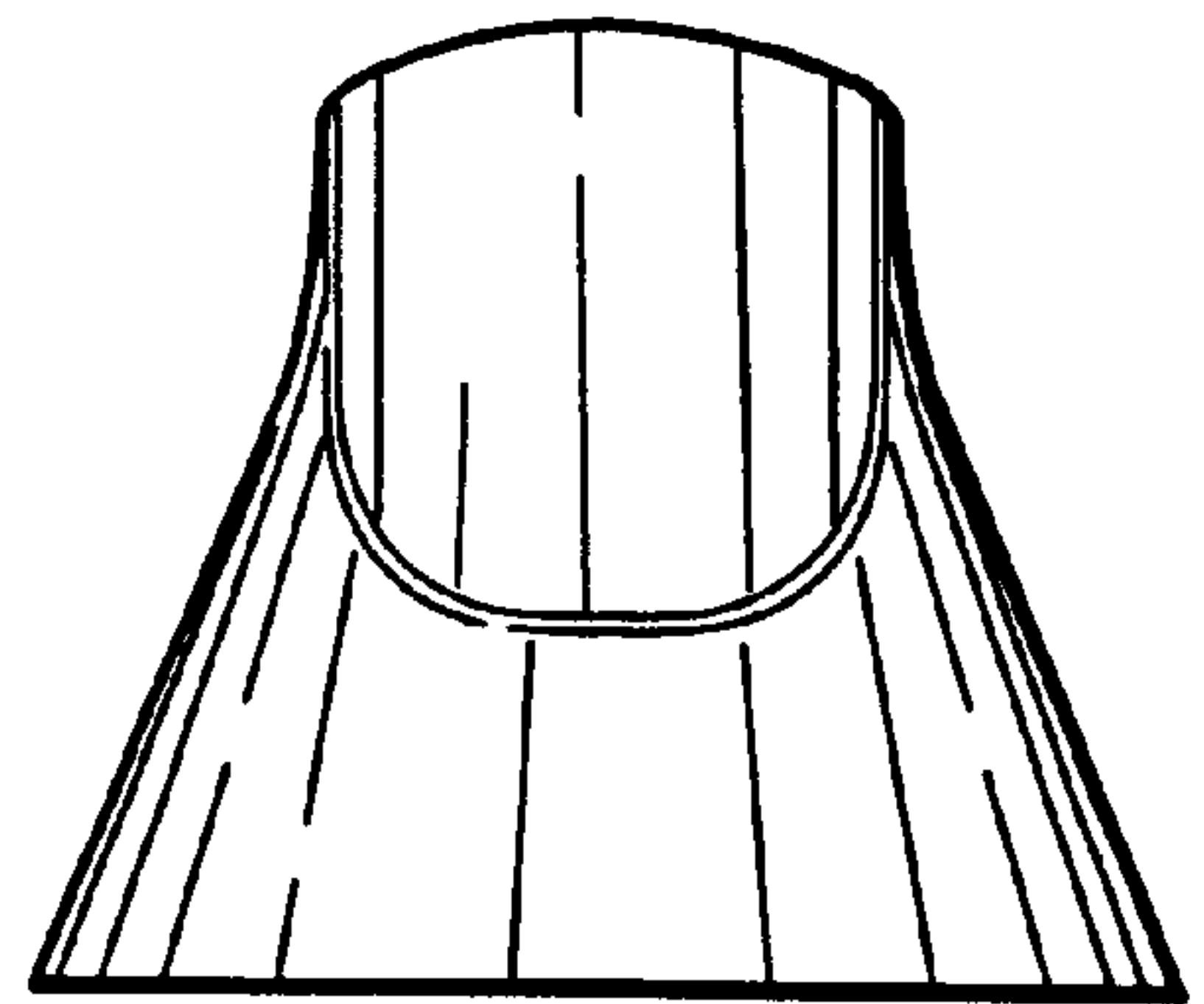

FIG. 3

FIG. 4

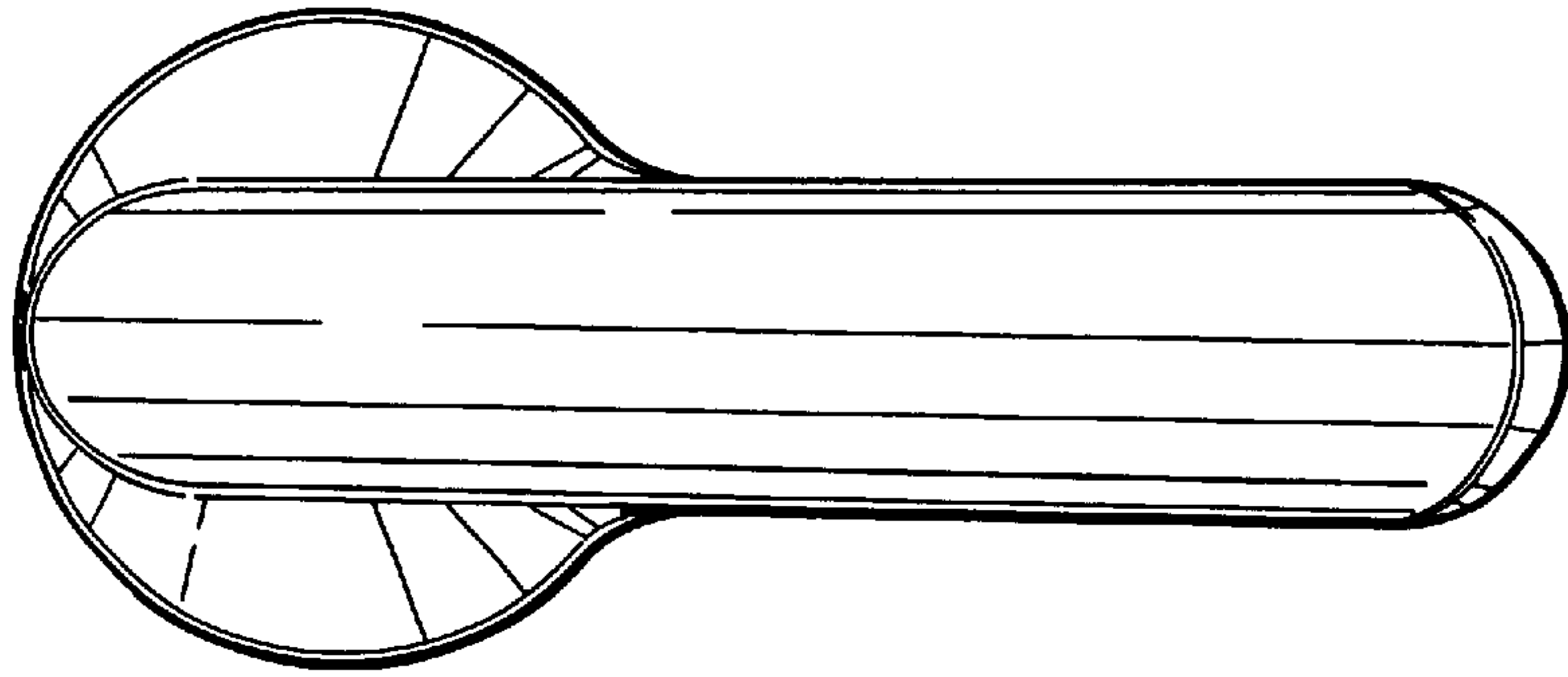

FIG. 5

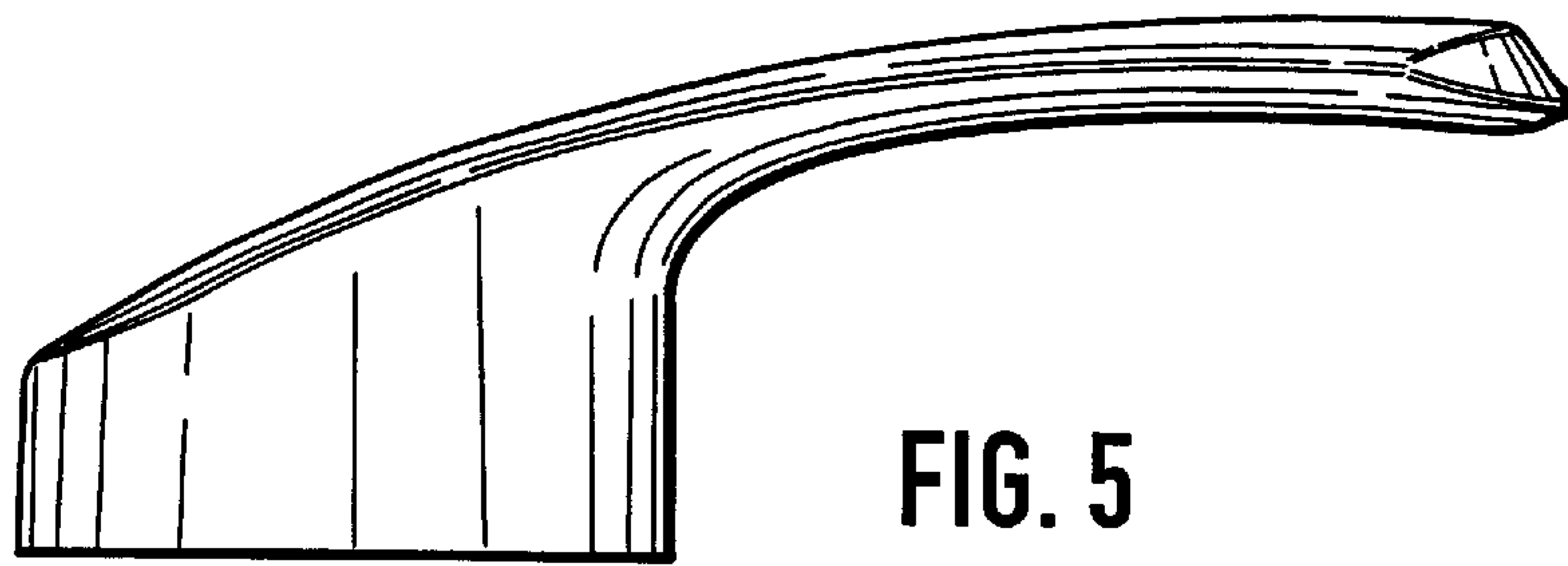

FIG. 6

