



US00D458298S

(12) **United States Design Patent**  
**Katsuyama et al.**

(10) **Patent No.:** **US D458,298 S**

(45) **Date of Patent:** **\*\* Jun. 4, 2002**

(54) **DIGITAL COLOR COPYING MACHINE**

D433,439 S \* 11/2000 Yoshida et al. .... D18/36  
D443,635 S \* 6/2001 Ogawa et al. .... D18/39  
D447,765 S \* 9/2001 Hatanaka et al. .... D18/39

(75) Inventors: **Goro Katsuyama**, Kanagawa; **Tamaki Someya**, Saitama; **Makoto Kurata**, Kanagawa, all of (JP)

\* cited by examiner

(73) Assignee: **Ricoh Company, Ltd.**, Tokyo (JP)

*Primary Examiner*—Caron D. Veynar  
(74) *Attorney, Agent, or Firm*—Dickstein Shapiro Morin & Oshinsky LLP

(\*\*) Term: **14 Years**

(57) **CLAIM**

(21) Appl. No.: **29/150,221**

The ornamental design for a digital color copying machine, as shown.

(22) Filed: **Nov. 14, 2001**

(30) **Foreign Application Priority Data**

**DESCRIPTION**

Jun. 1, 2001 (JP) ..... 2001-015919

FIG. 1 is a front elevation of a digital color copying machine showing our new design;  
FIG. 2 is a rear elevation thereof;  
FIG. 3 is a top plan view thereof;  
FIG. 4 is a bottom plan view thereof;  
FIG. 5 is a right side elevation thereof;  
FIG. 6 is a left side elevation thereof; and,  
FIG. 7 is a top, front and right side perspective view thereof.

(51) **LOC (7) Cl.** ..... **16-03**

(52) **U.S. Cl.** ..... **D18/36**

(58) **Field of Search** ..... D18/36-39, 53-56;  
399/1-7, 81, 130; 355/97

(56) **References Cited**

**U.S. PATENT DOCUMENTS**

D374,454 S \* 10/1996 Naruki et al. .... D18/36

**1 Claim, 4 Drawing Sheets**

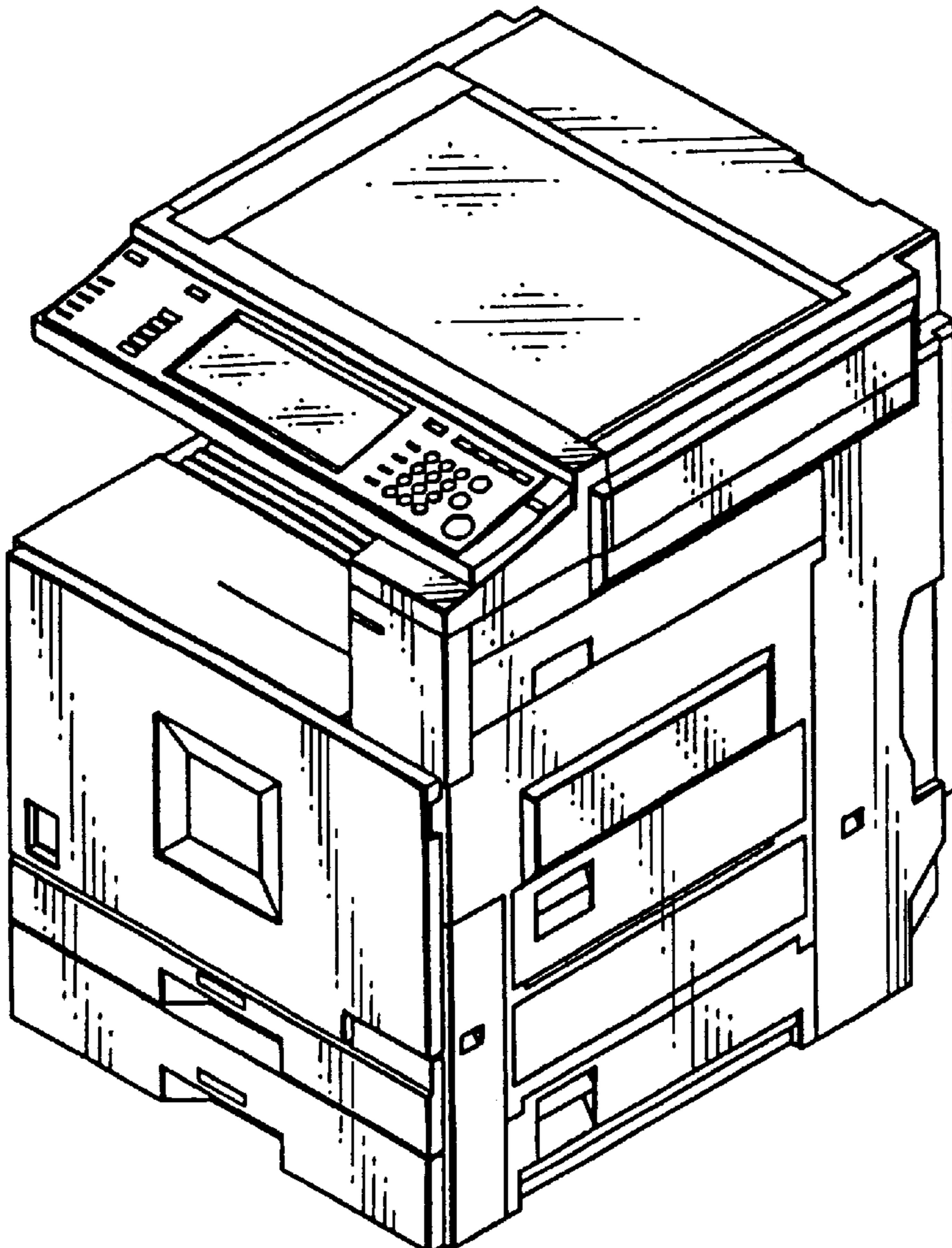

FIG. 1

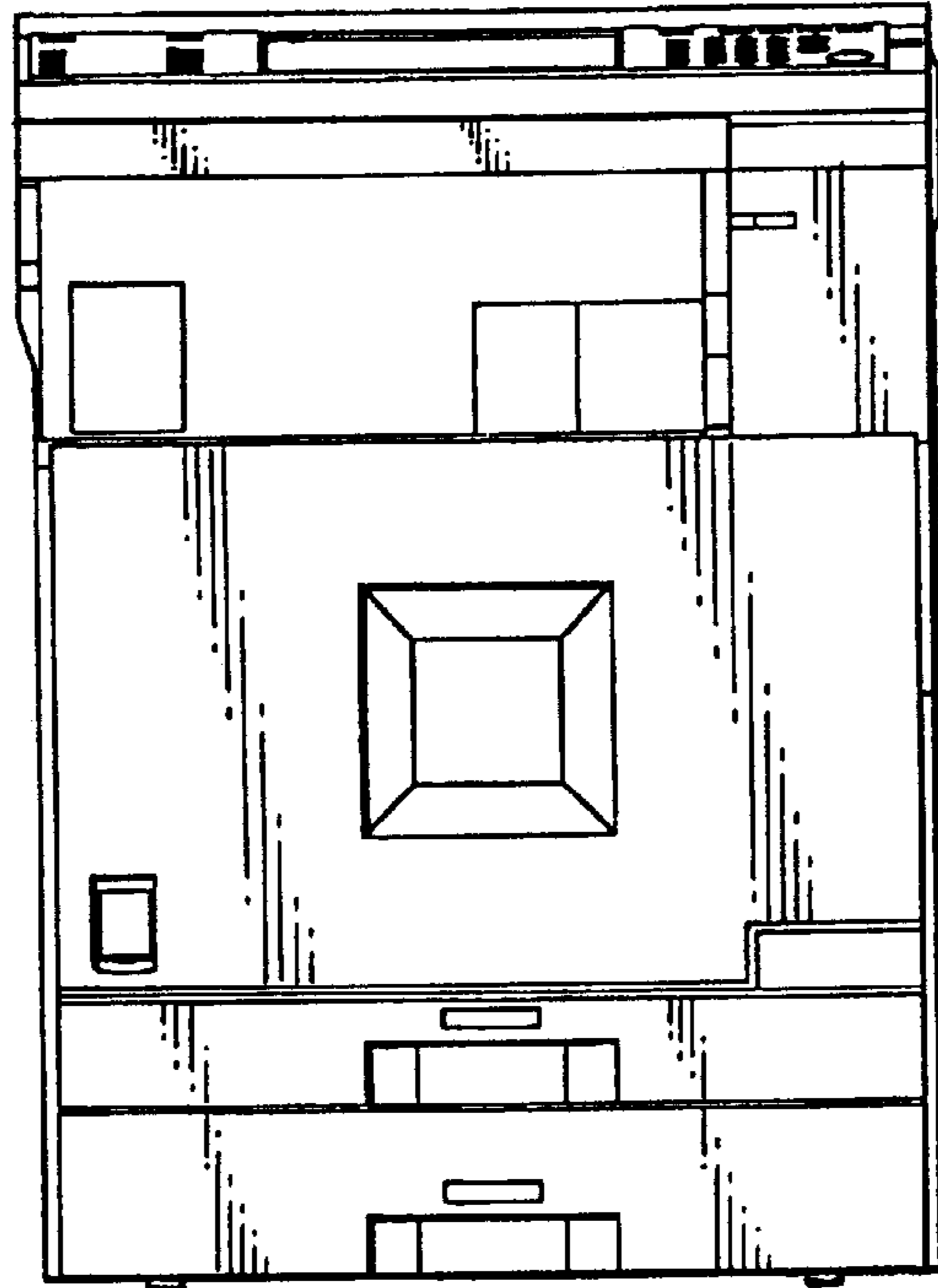

FIG. 2

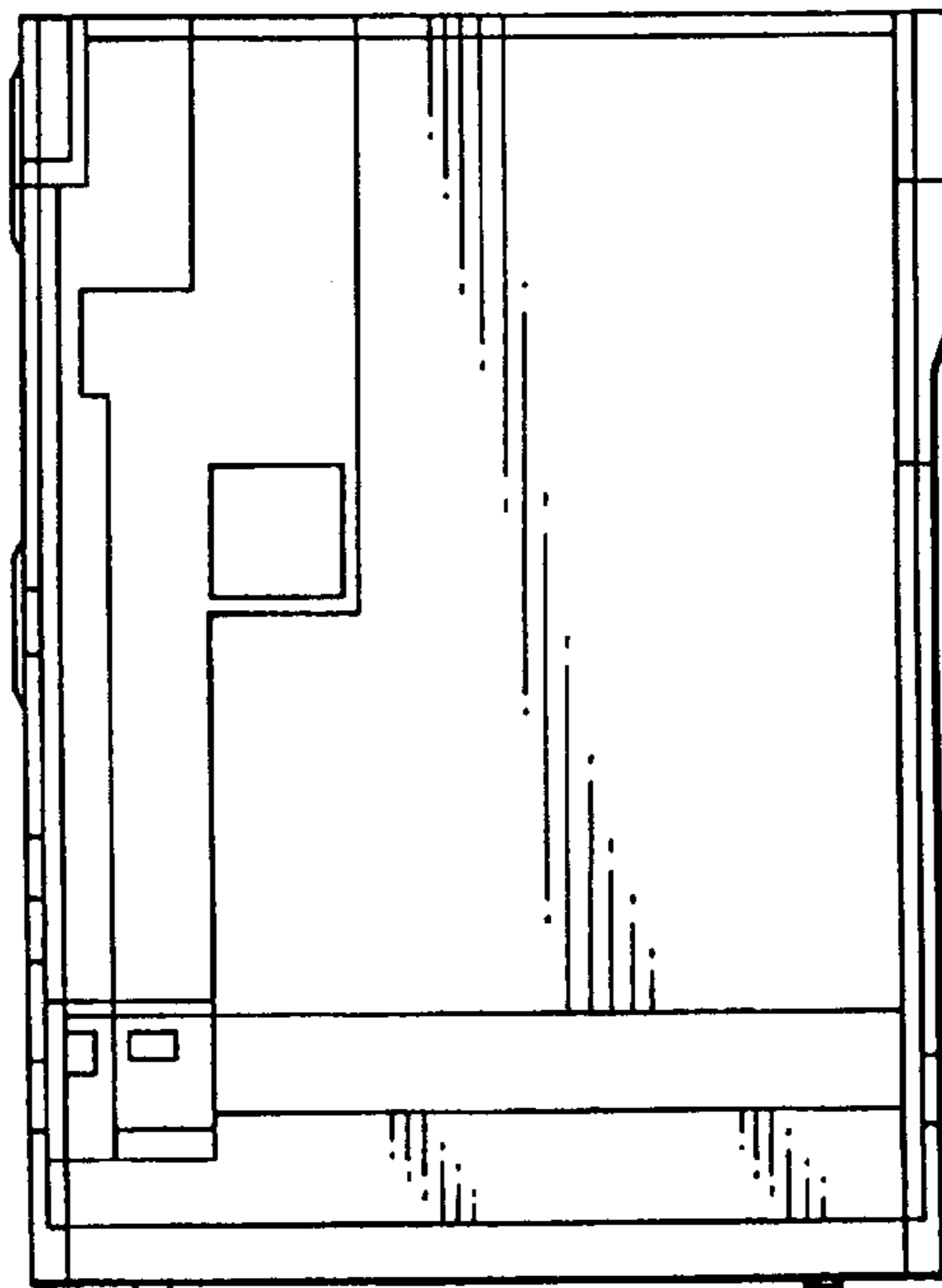

FIG. 3

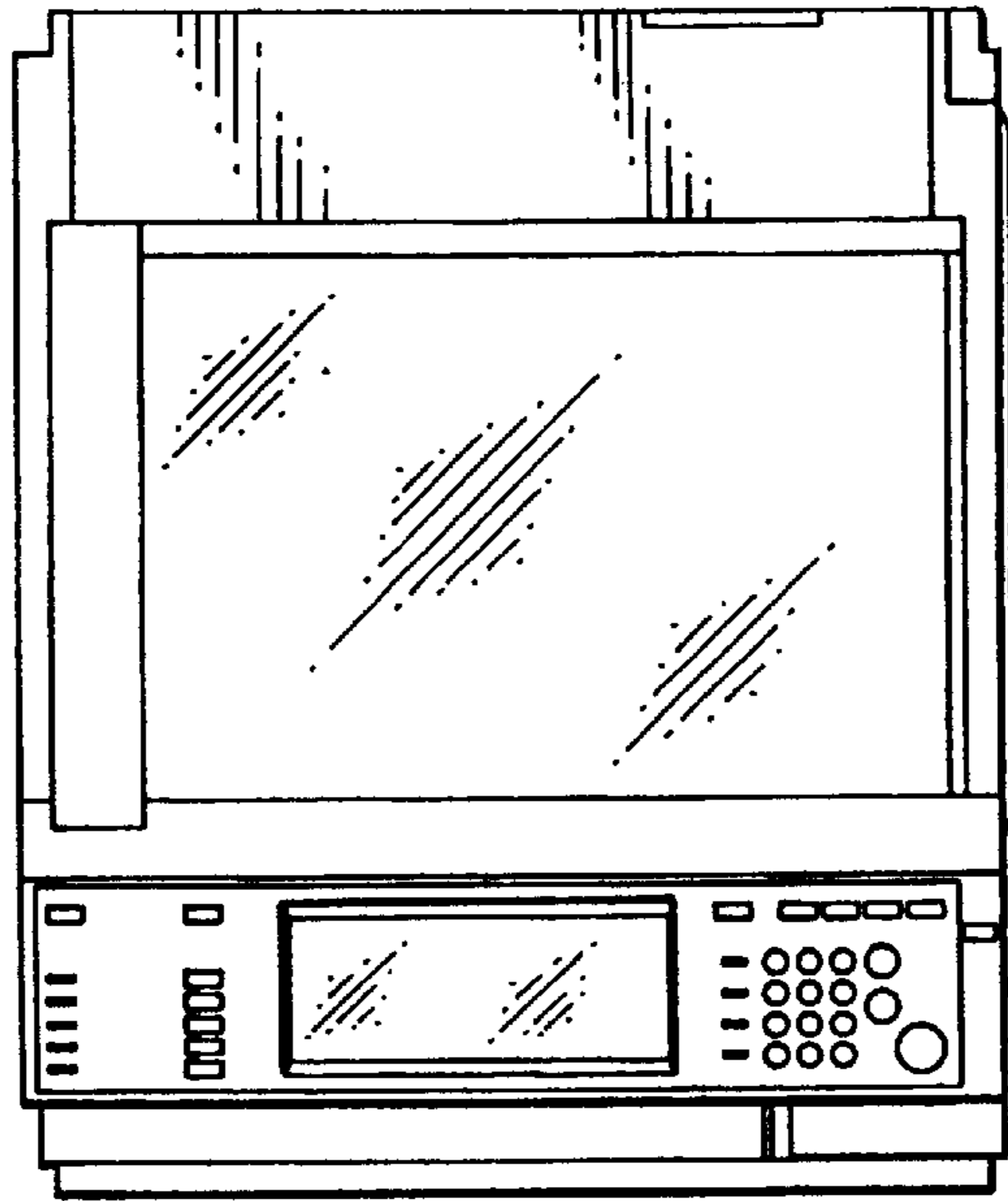

FIG. 4

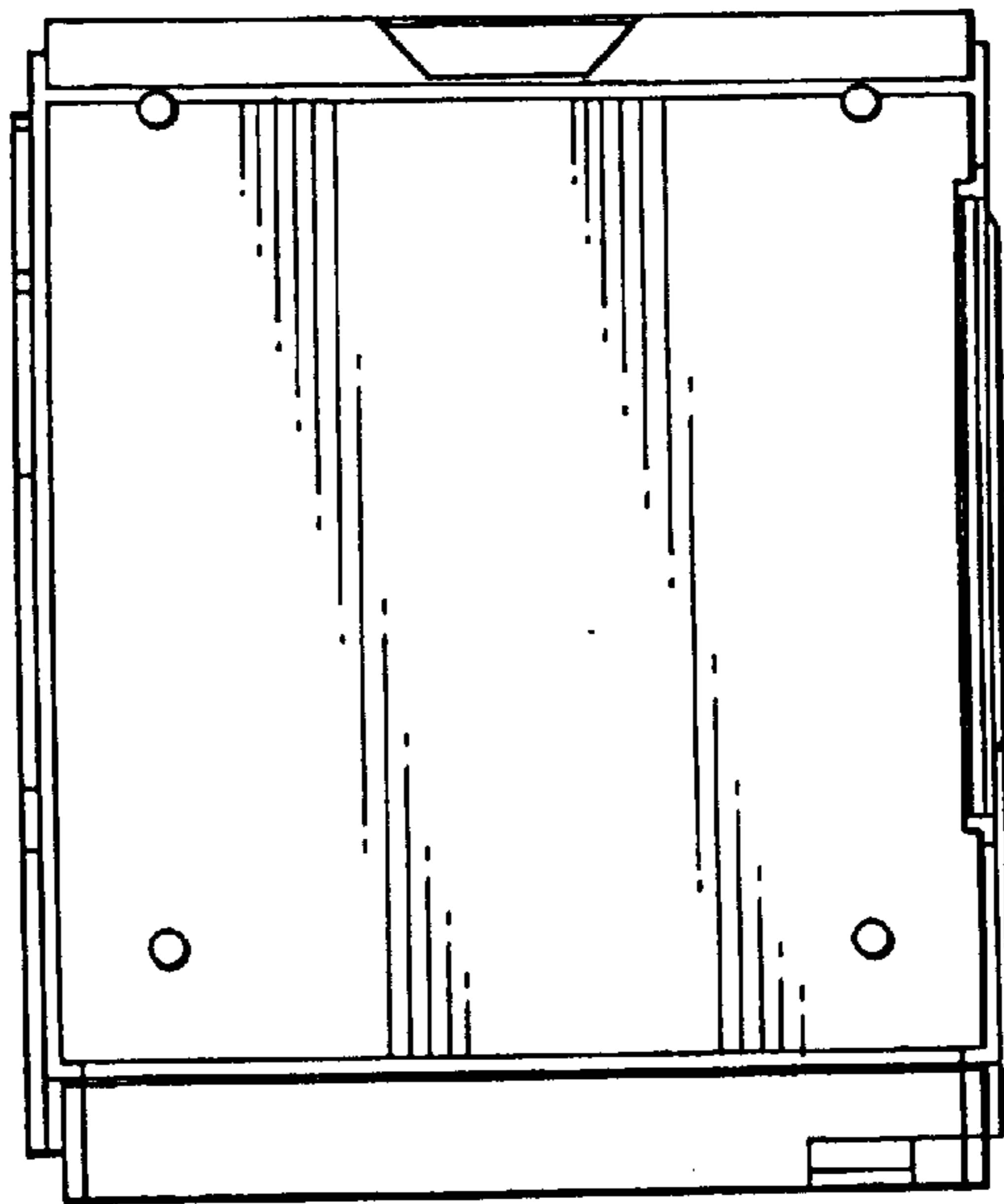

FIG. 5

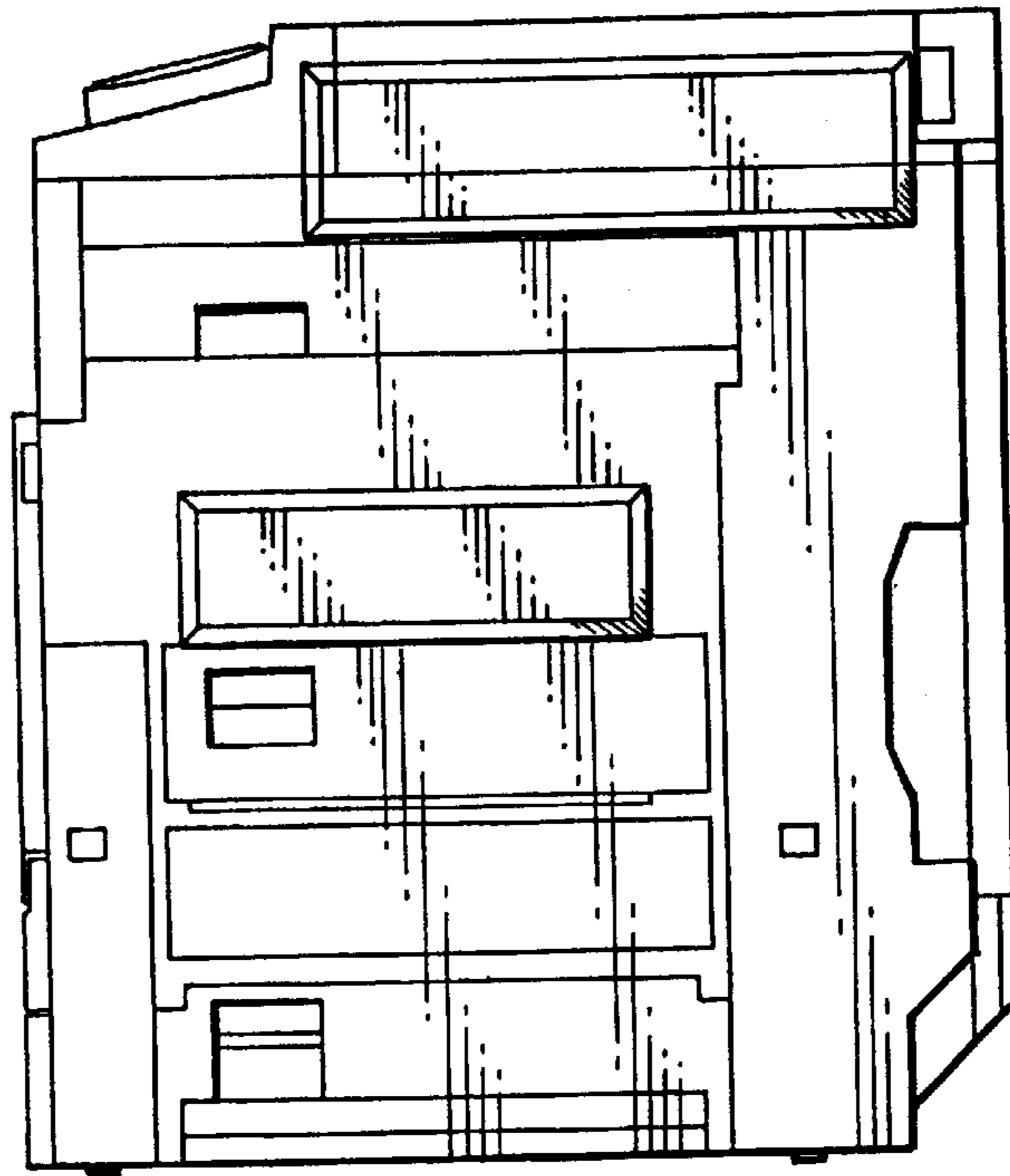

FIG. 6

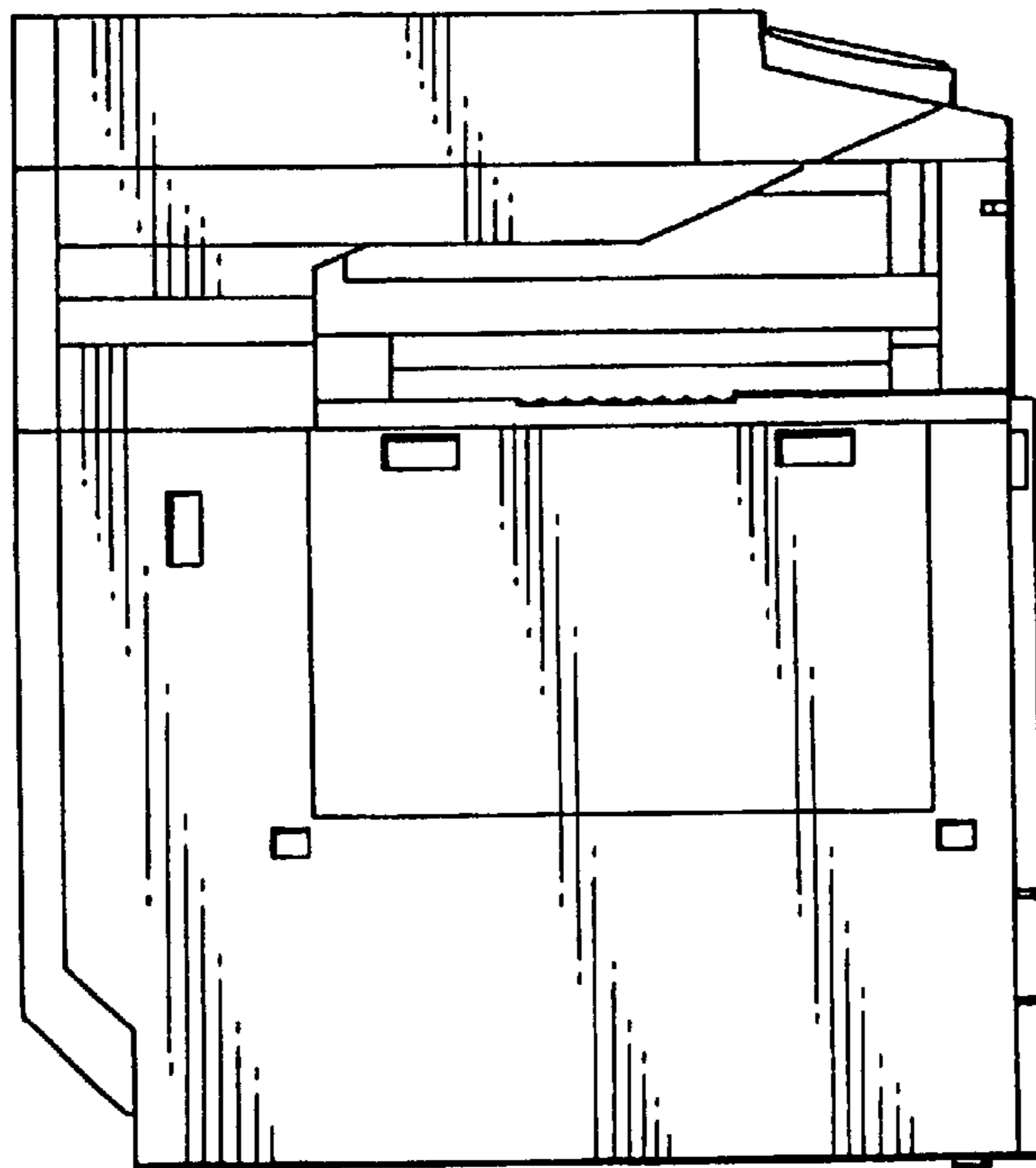

FIG. 7

