



US00D458294S

(12) **United States Design Patent**  
**Makidera**

(10) **Patent No.:** **US D458,294 S**

(45) **Date of Patent:** **\*\* Jun. 4, 2002**

(54) **ELECTRONIC CALCULATOR WITH PRINTER**

(75) **Inventor:** **Toru Makidera, Nara-ken (JP)**

(73) **Assignee:** **Sharp Kabushiki Kaisha, Osaka (JP)**

(\*\*) **Term:** **14 Years**

(21) **Appl. No.:** **29/148,461**

(22) **Filed:** **Sep. 21, 2001**

(30) **Foreign Application Priority Data**

Mar. 21, 2001 (JP) ..... 2000-007275

(51) **LOC (7) Cl.** ..... **18-01**

(52) **U.S. Cl.** ..... **D18/7**

(58) **Field of Search** ..... D18/1-12; 235/1 R,  
235/61 R; 364/705-710

(56) **References Cited**

**U.S. PATENT DOCUMENTS**

D280,418 S	*	9/1985	Hayashi et al. ....	D18/7
D285,575 S	*	9/1986	Satake .....	D18/7
D308,532 S	*	6/1990	Sakaguchi et al. ....	D18/7
D308,533 S	*	6/1990	Sakaguchi et al. ....	D18/7
D315,358 S	*	3/1991	Yubisui et al. ....	D18/7

D315,572 S	*	3/1991	Sakaguchi et al. ....	D18/7
D318,286 S	*	7/1991	Sakaguchi et al. ....	D18/7
D349,511 S		8/1994	Sakaguchi et al. ....	D18/7
D350,148 S		8/1994	Yubisui et al. ....	D18/7
D355,166 S		2/1995	Sakaguchi et al. ....	D18/7 X
D394,449 S		5/1998	Shimizu .....	D18/7
D433,056 S		10/2000	Tamaki .....	D18/7
D442,618 S		5/2001	Tamaki .....	D18/7

\* cited by examiner

*Primary Examiner*—Caron D. Veynar

(74) *Attorney, Agent, or Firm*—Nixon & Vanderhye

(57) **CLAIM**

The ornamental design for an “electronic calculator with printer”, as shown and described.

**DESCRIPTION**

FIG. 1 is a top, front and right side perspective view of an electronic calculator with printer according to my design; FIG. 2 is a front elevational view thereof; FIG. 3 is a rear elevational view thereof; FIG. 4 is right side elevational view thereof; FIG. 5 is a left side elevational view thereof; FIG. 6 is a top plan view thereof; and, FIG. 7 is a bottom plan view.

**1 Claim, 5 Drawing Sheets**

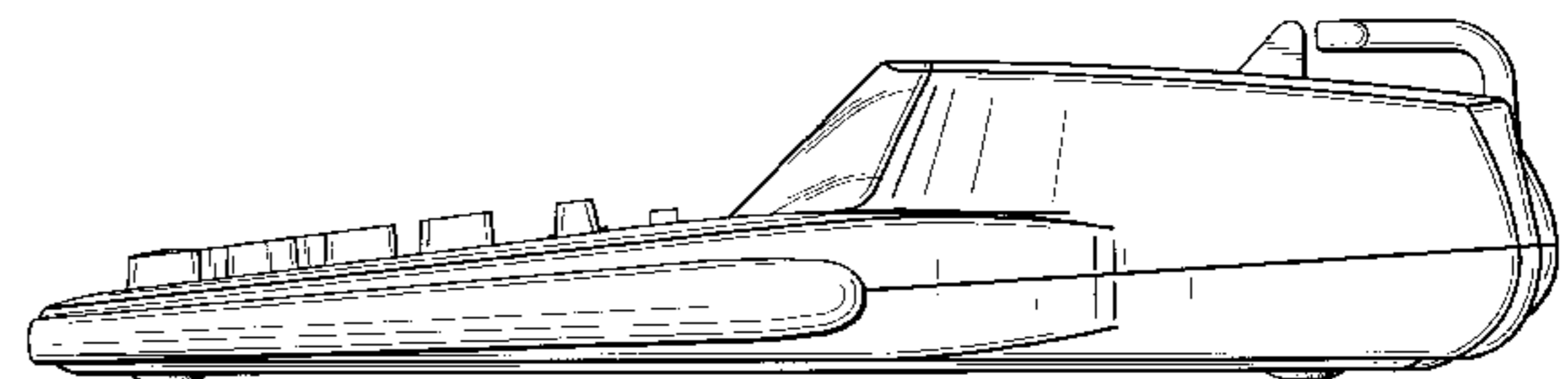
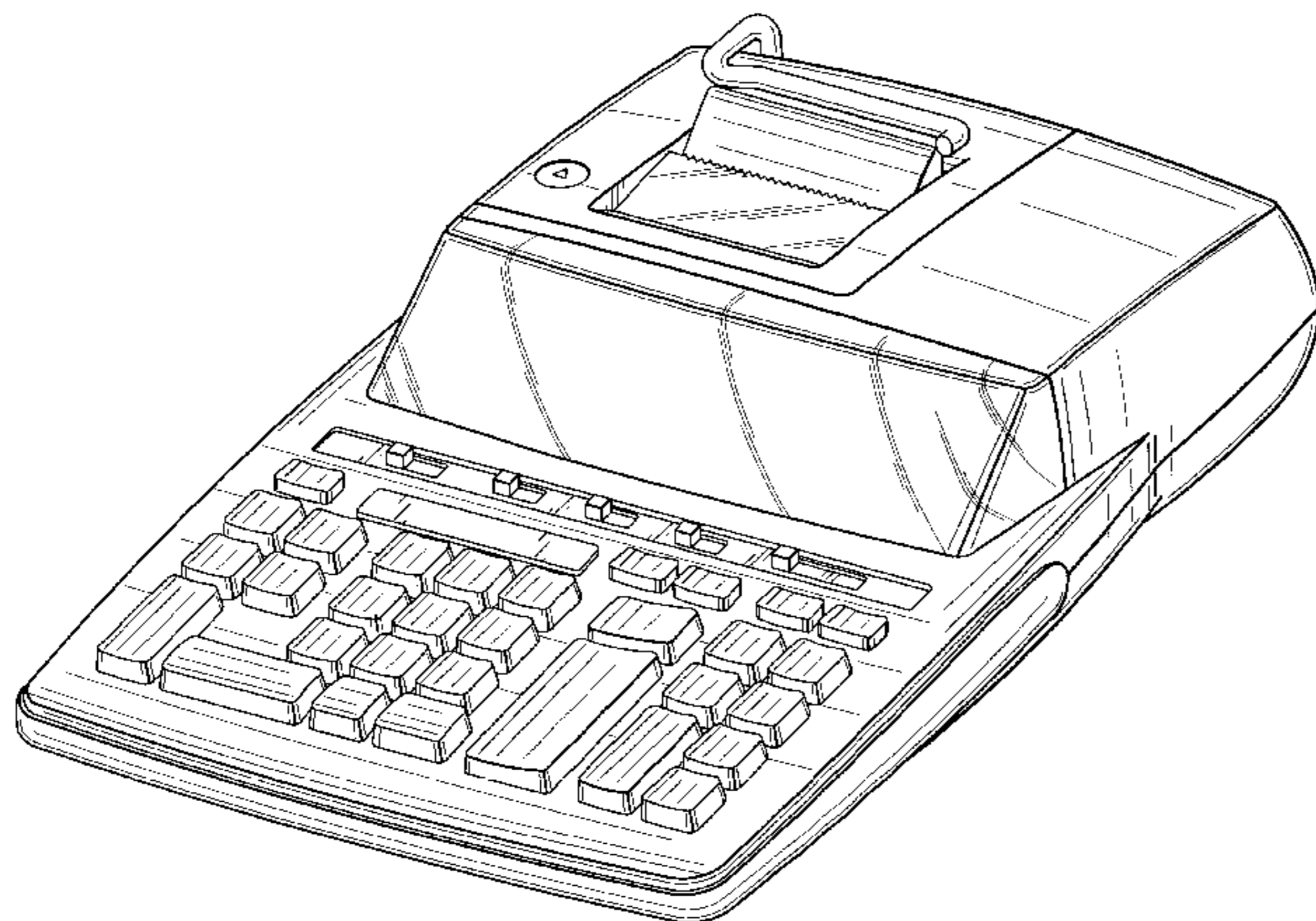

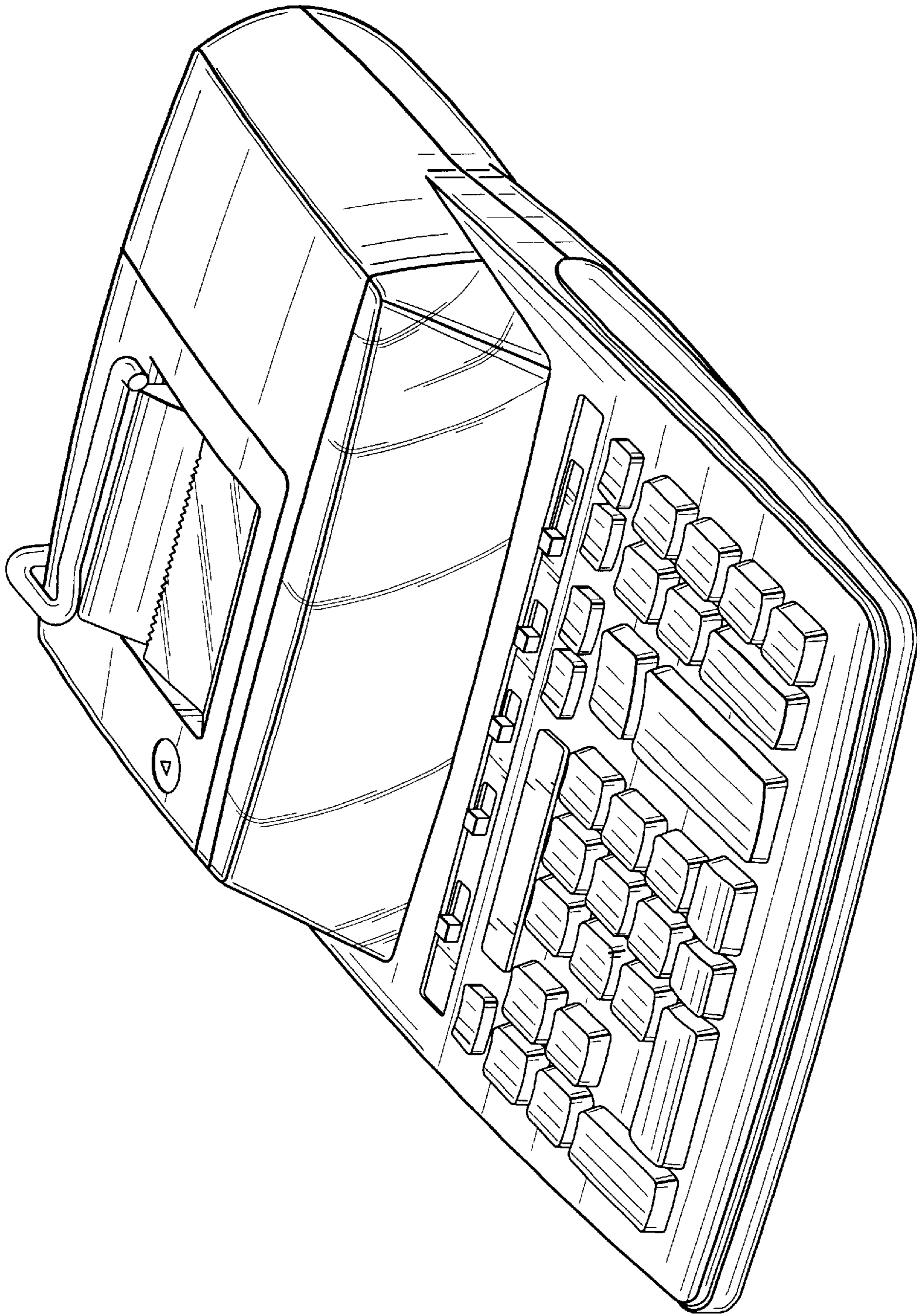

Fig. 1

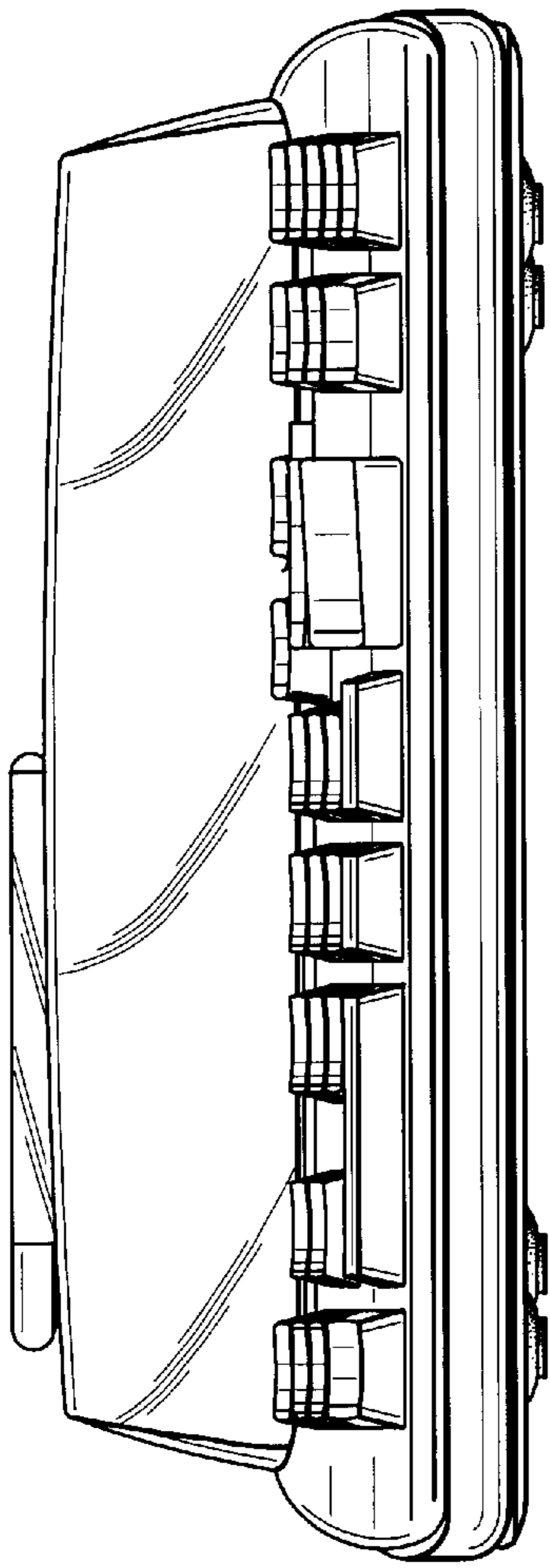

Fig. 2

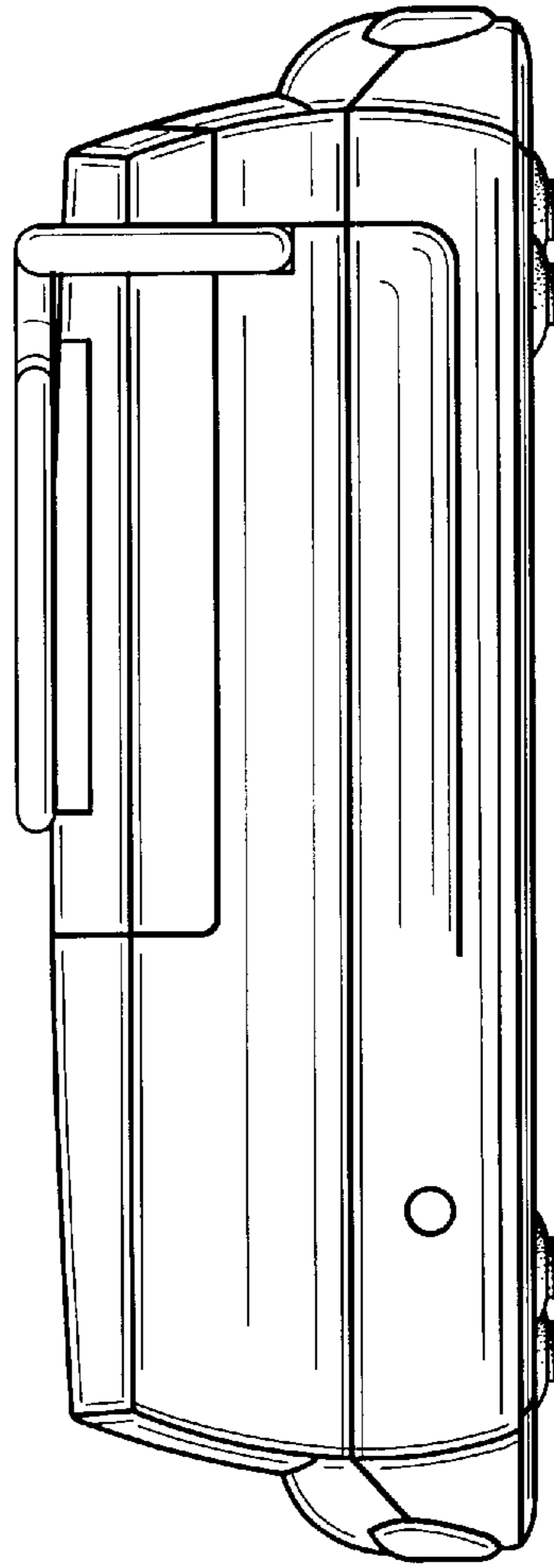

Fig. 3

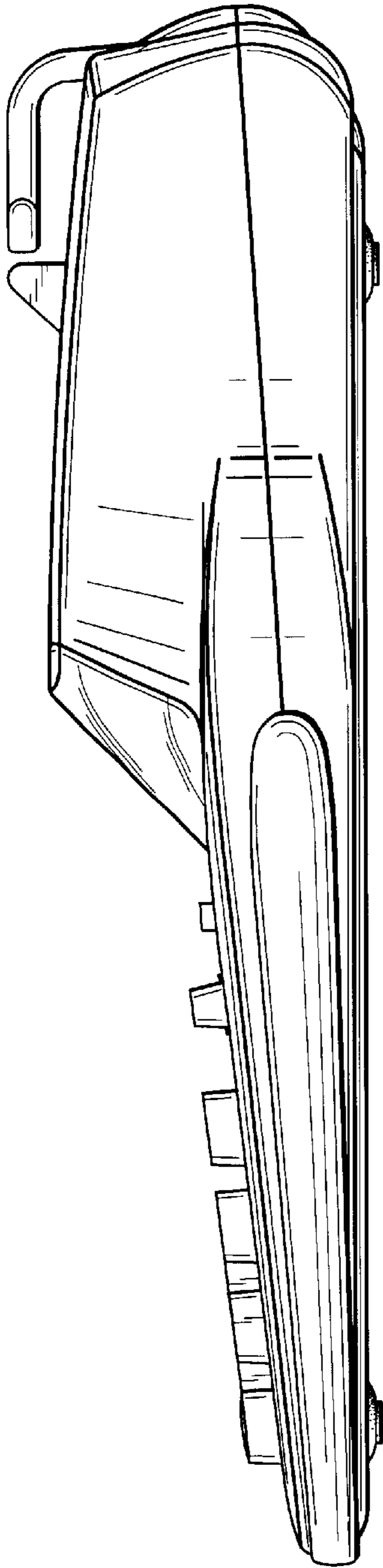

Fig.4

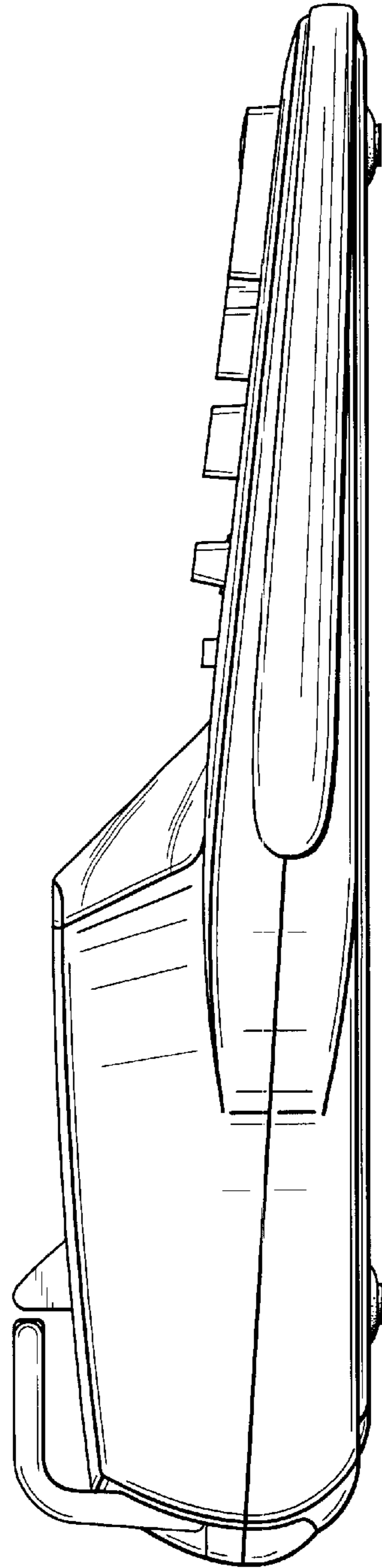

Fig.5

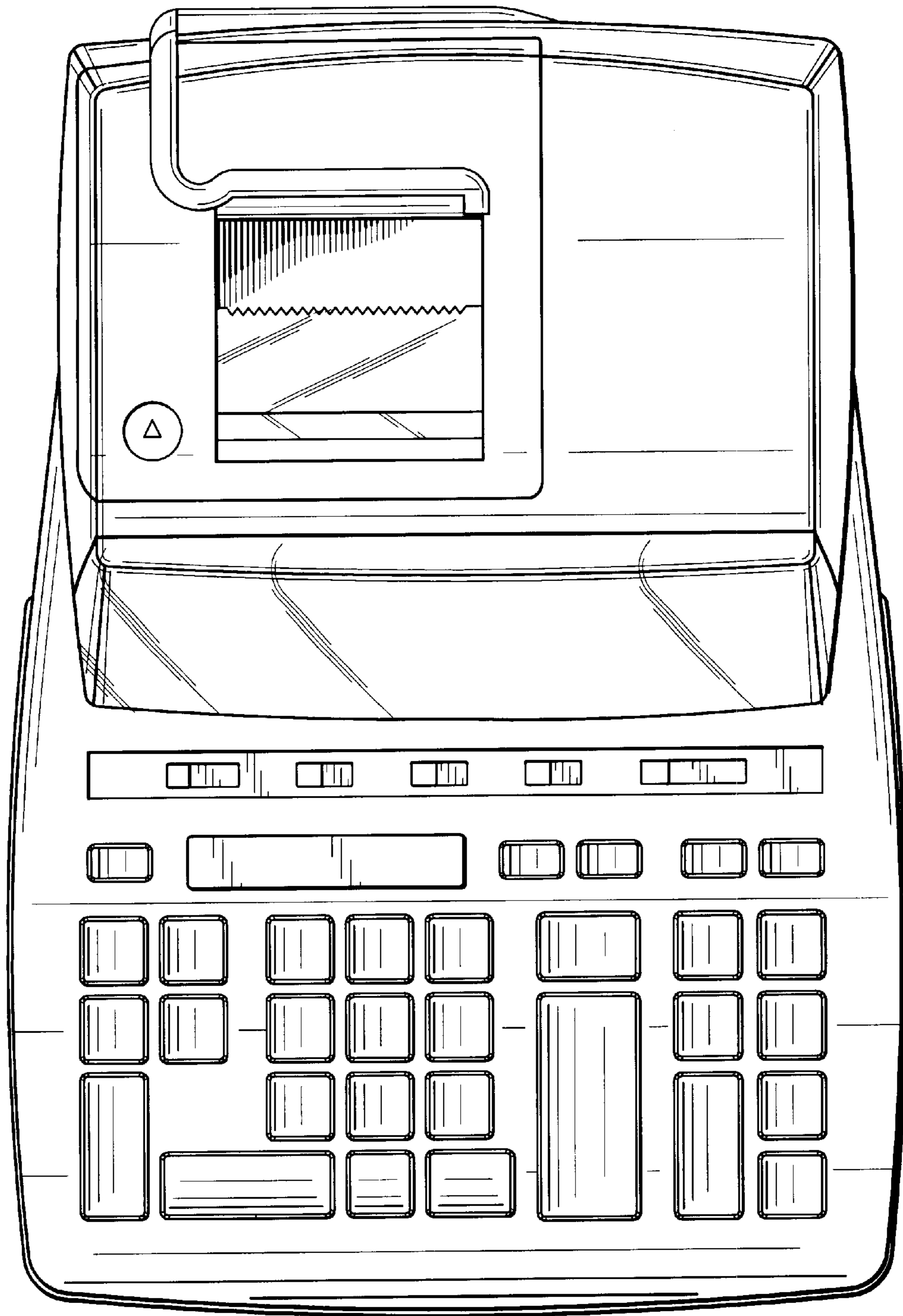

Fig.6

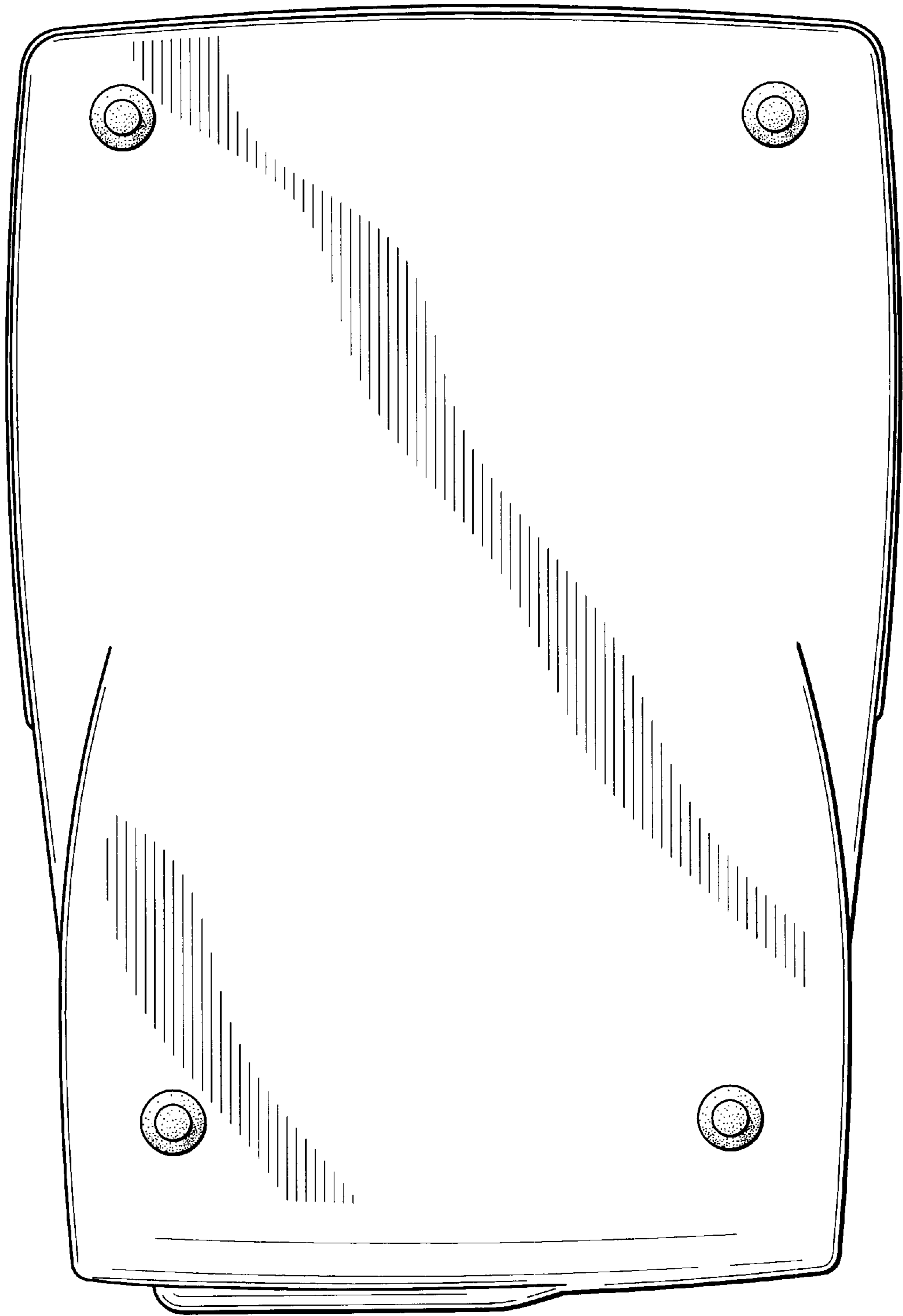

Fig.7

UNITED STATES PATENT AND TRADEMARK OFFICE  
**CERTIFICATE OF CORRECTION**

PATENT NO. : Des. 458,294  
DATED : June 4, 2002  
INVENTOR(S) : Makidera

Page 1 of 1

It is certified that error appears in the above-identified patent and that said Letters Patent is hereby corrected as shown below:

Title page,

Item [30], the number of the underlying Japanese patent application should read  
-- 2001-007275 --.

Signed and Sealed this

Third Day of December, 2002

A handwritten signature in black ink, appearing to read "James E. Rogan", with a horizontal line drawn underneath it.

JAMES E. ROGAN  
*Director of the United States Patent and Trademark Office*