



US00D458161S

(12) **United States Design Patent**
Lie

(10) **Patent No.:** **US D458,161 S**

(45) **Date of Patent:** **** Jun. 4, 2002**

(54) **EAR THERMOMETER**

(75) Inventor: **Chien-Chang Lie**, Tao Yuan Hsien (TW)

(73) Assignee: **Norm Pacific Automation Corp.**, Hsinchu Hsien (TW)

(**) Term: **14 Years**

(21) Appl. No.: **29/144,542**

(22) Filed: **Jul. 6, 2001**

(51) **LOC (7) Cl.** **10-04**

(52) **U.S. Cl.** **D10/57**

(58) **Field of Search** D10/57; 128/664, 128/736; 374/130, 131, 208; 600/474

(56) **References Cited**

U.S. PATENT DOCUMENTS

D419,893 S * 2/2000 Cheng D10/57

* cited by examiner

Primary Examiner—Antoine Duval Davis

(74) *Attorney, Agent, or Firm*—Rosenberg, Klein & Lee

(57) **CLAIM**

The ornamental design for an ear thermometer, as shown and described.

DESCRIPTION

FIG. 1 is a perspective view of an ear thermometer showing my present design;

FIG. 2 is a front view thereof;

FIG. 3 is a rear view thereof;

FIG. 4 is a left view thereof;

FIG. 5 is a right view thereof;

FIG. 6 is a top plan view thereof; and,

FIG. 7 is a bottom plan view.

1 Claim, 5 Drawing Sheets

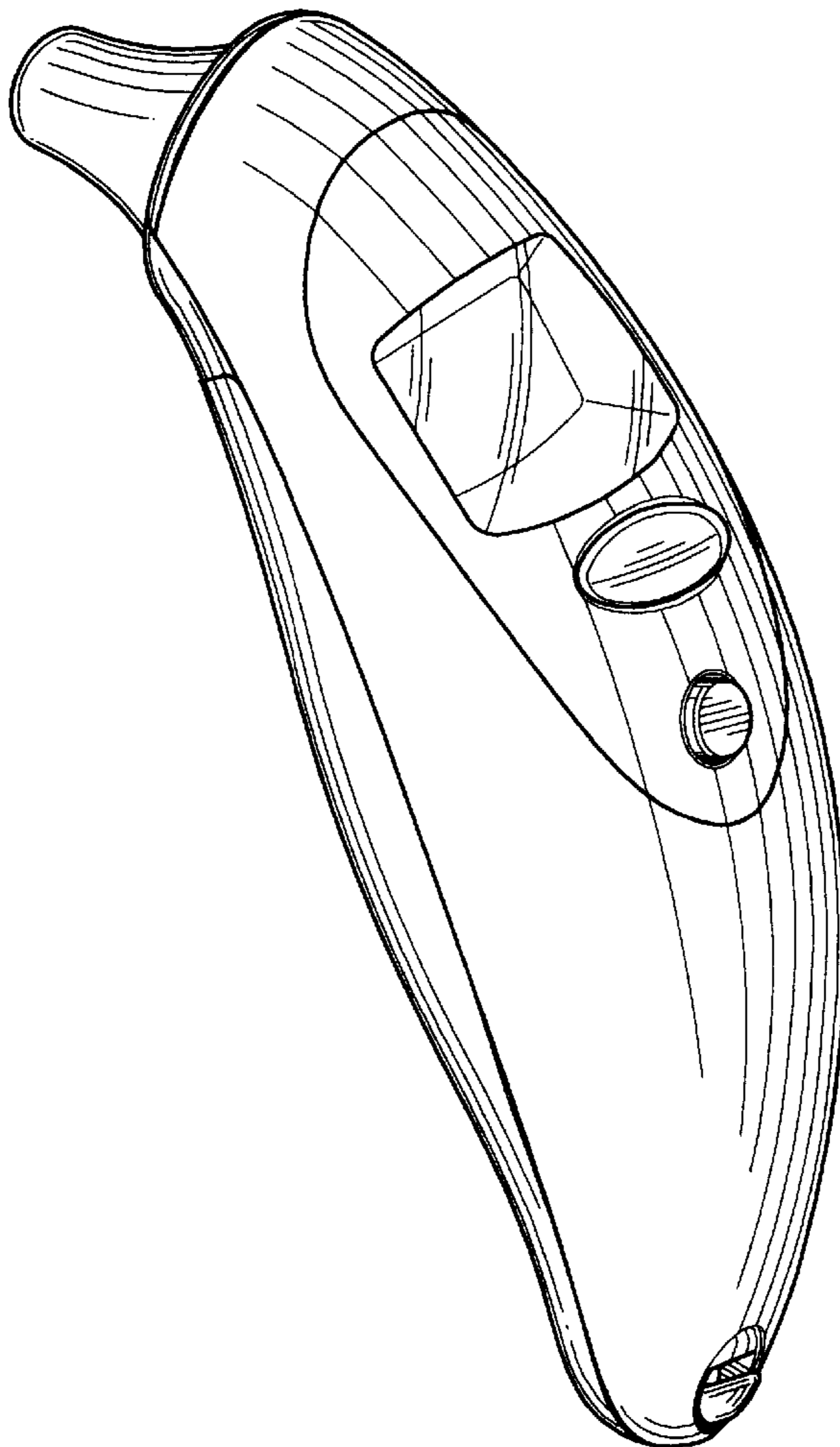

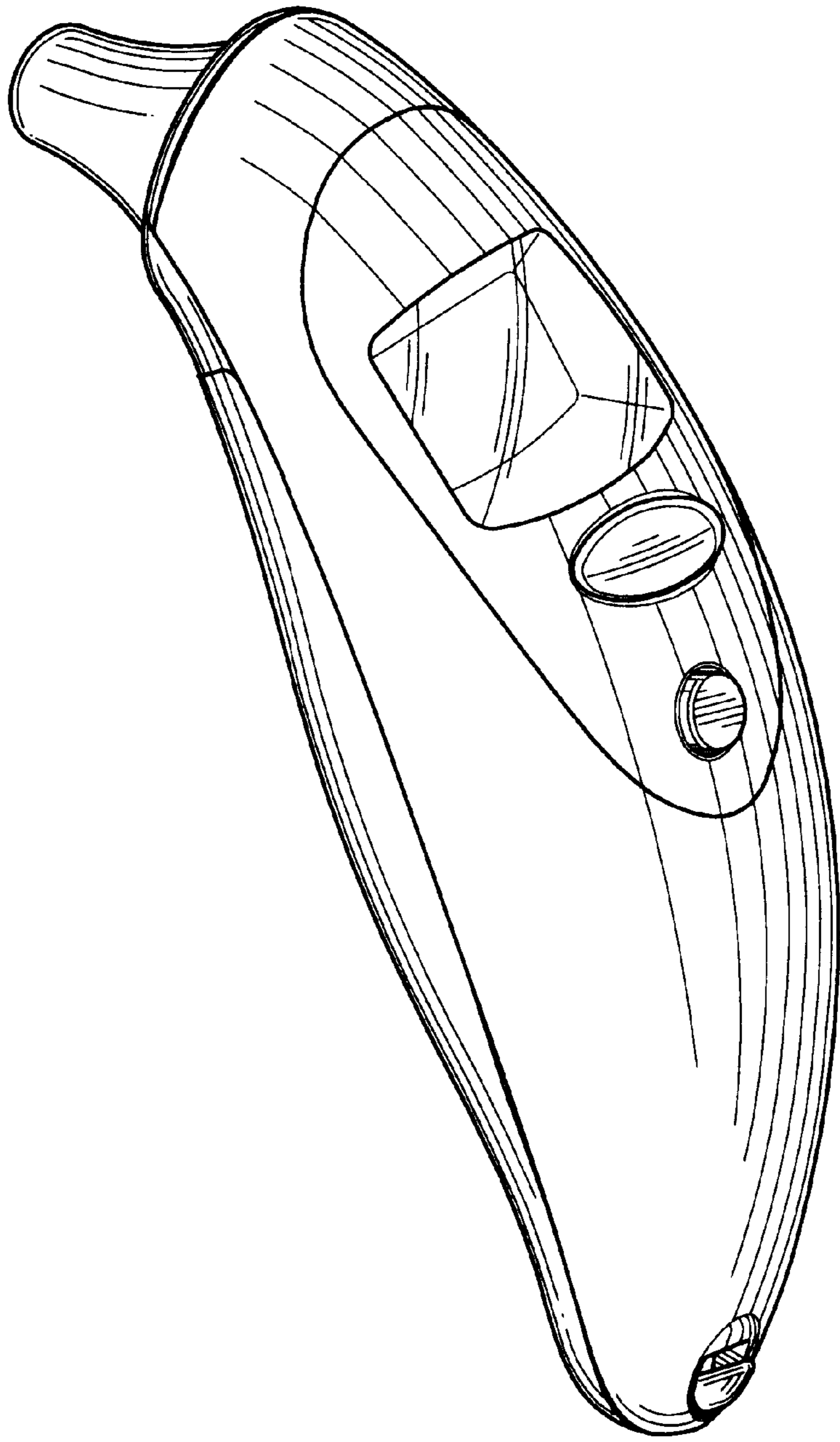

FIG. 1

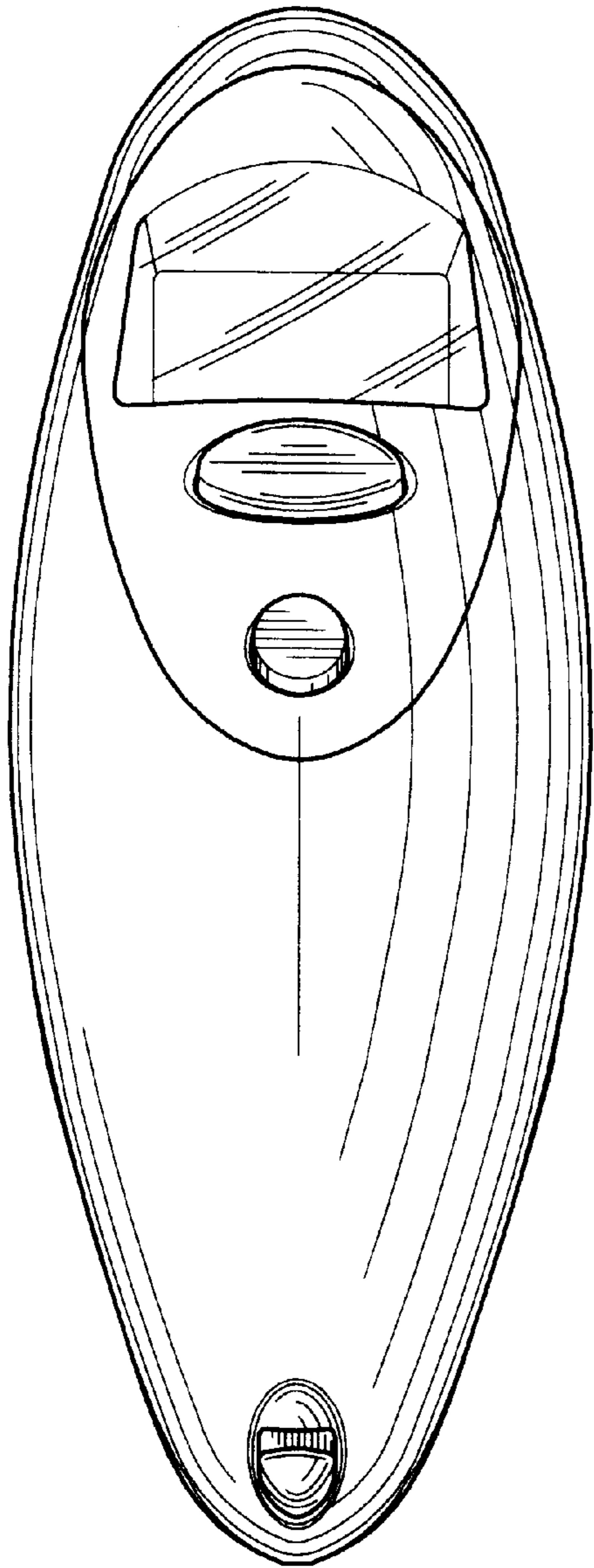

FIG. 2

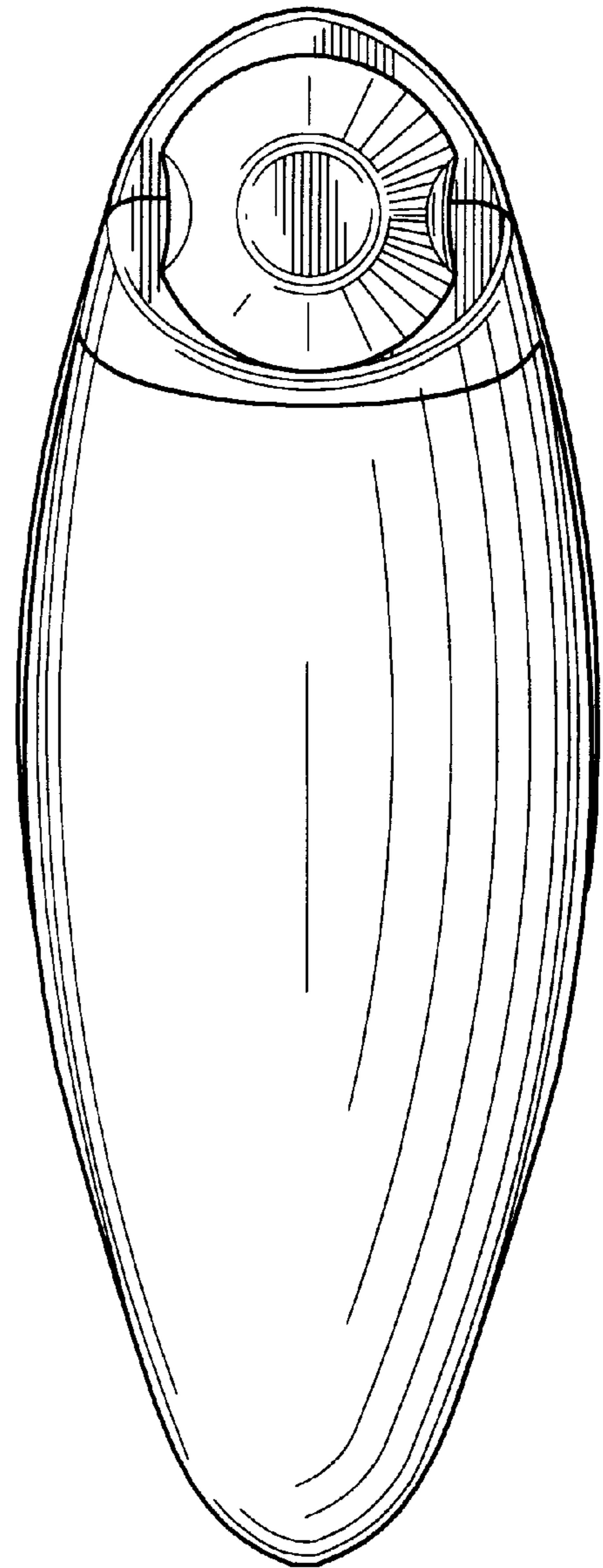

FIG. 3

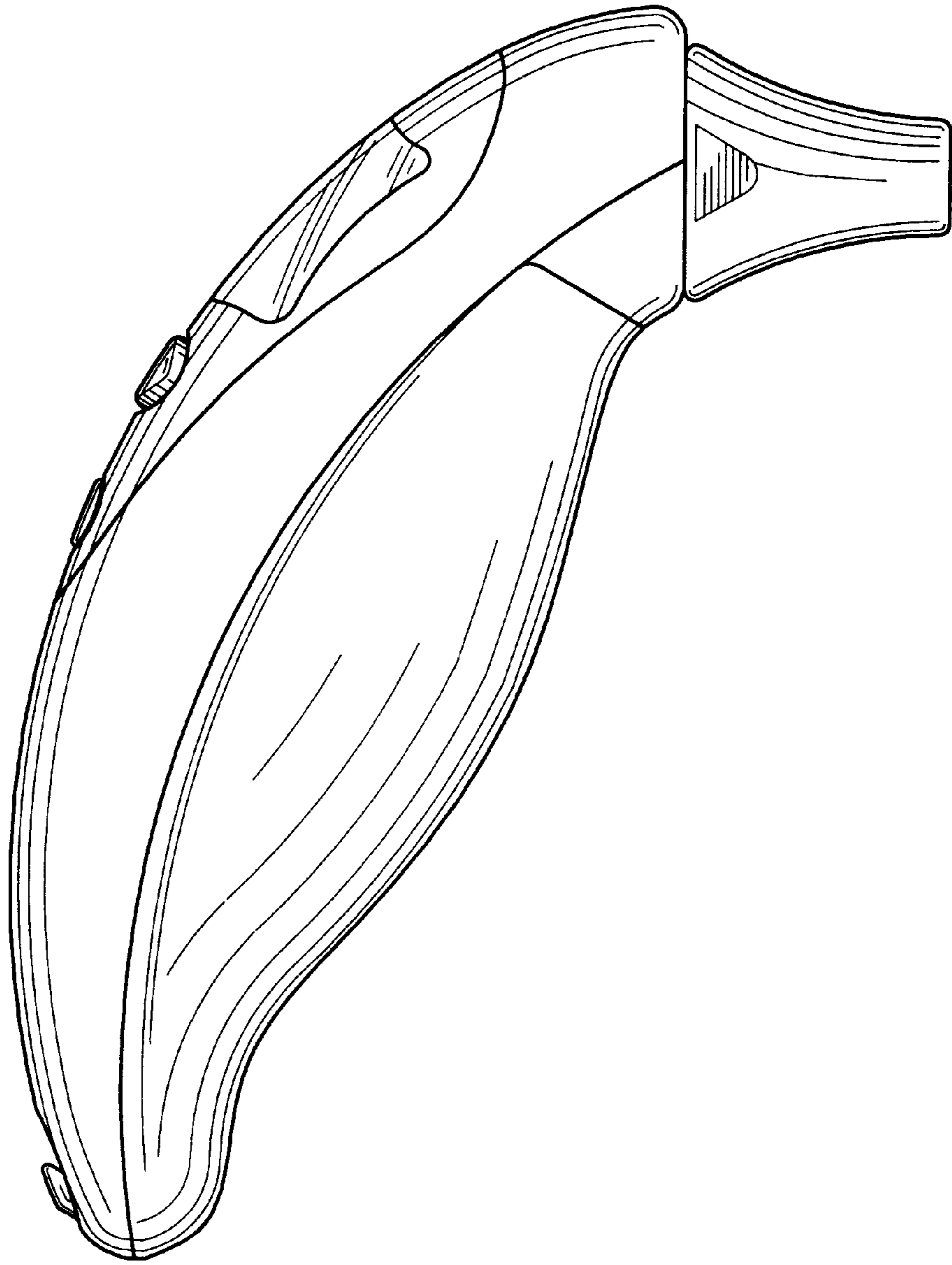

FIG. 4

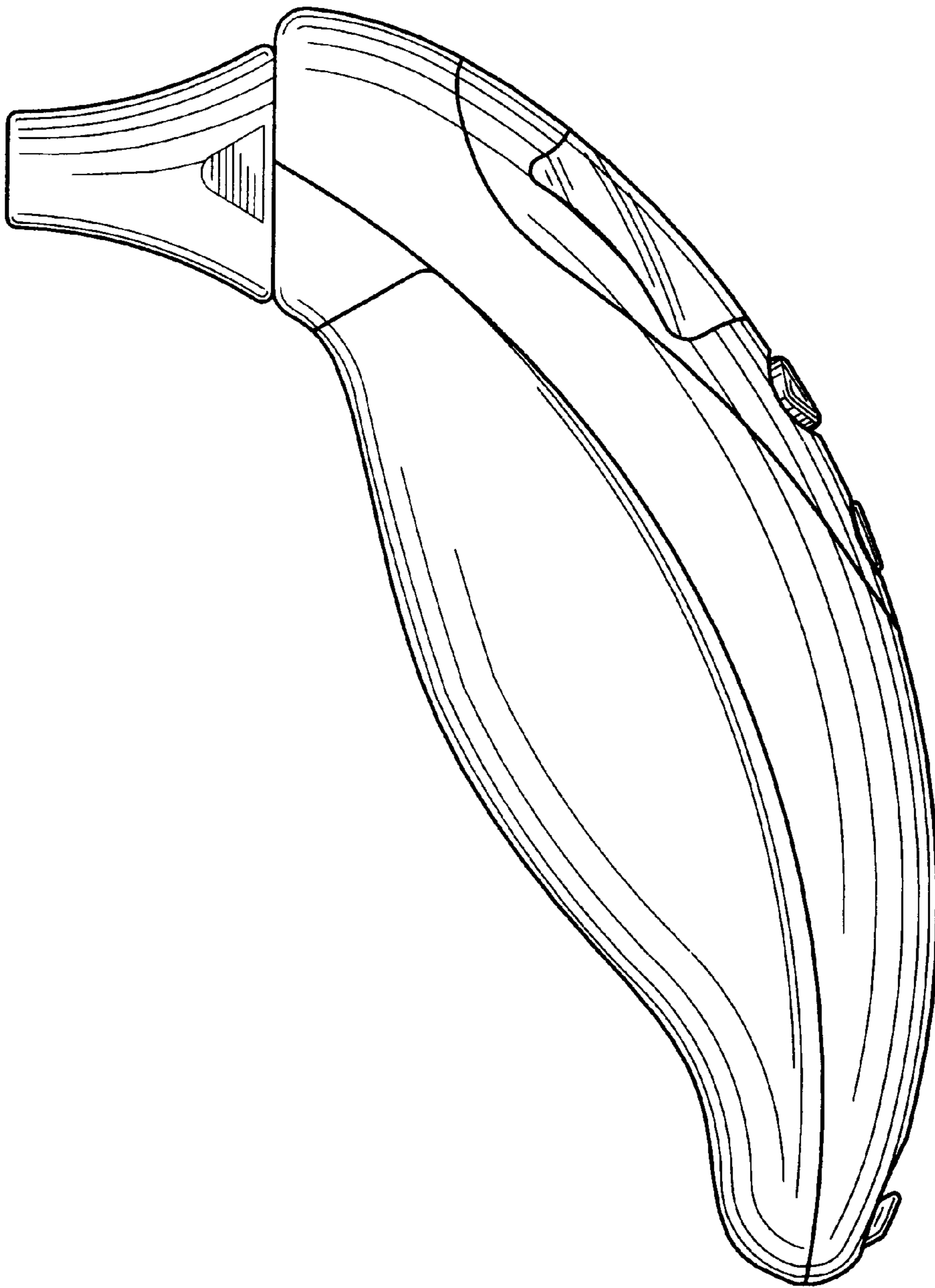

FIG. 5

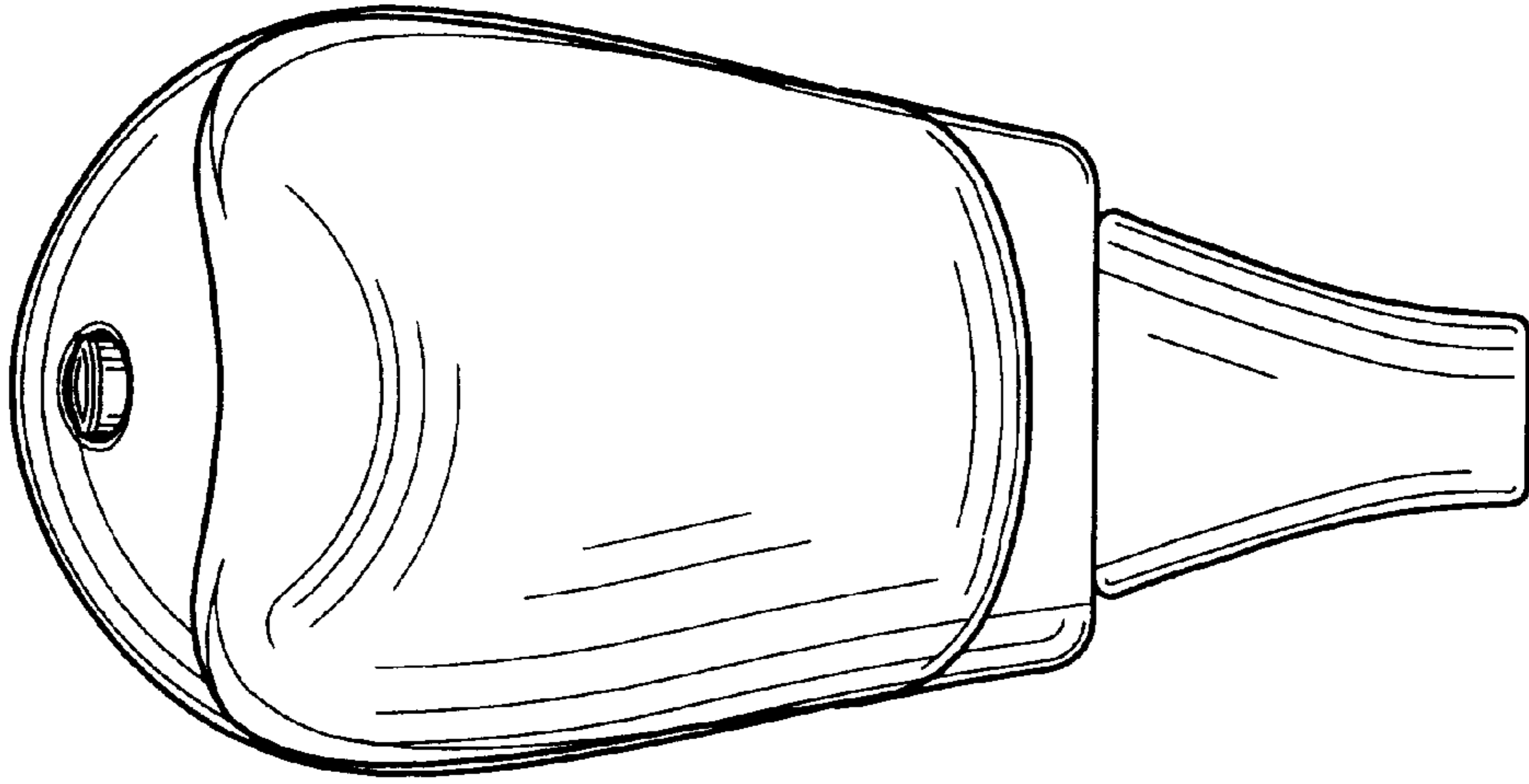

FIG. 7

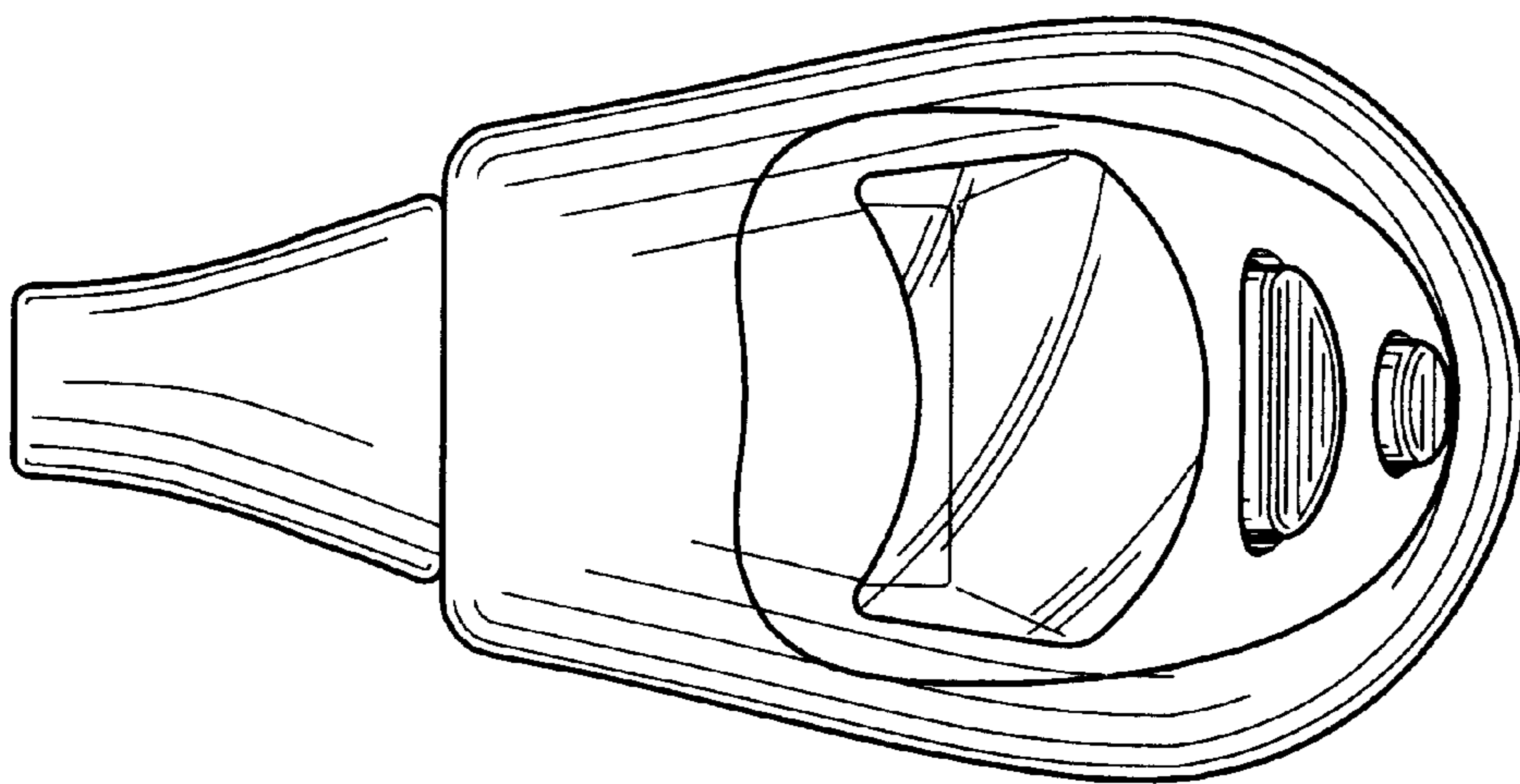

FIG. 6