



US00D458113S

(12) **United States Design Patent**
Yang

(10) **Patent No.:** **US D458,113 S**

(45) **Date of Patent:** **** Jun. 4, 2002**

(54) **HOSE RECEIVING DEVICE**

5,628,341 A * 5/1997 Bodden 242/398
D393,409 S * 4/1998 Azzarello D8/356

(76) Inventor: **Lung Yu Yang**, P.O. Box 63-99,
Taichung (TW), 406

* cited by examiner

(**) Term: **14 Years**

Primary Examiner—Doris V. Coles
Assistant Examiner—Elizabeth A. Albert

(21) Appl. No.: **29/150,789**

(57) **CLAIM**

(22) Filed: **Nov. 30, 2001**

The ornamental design for a hose receiving device, as shown and described.

(51) **LOC (7) Cl.** **08-05**

(52) **U.S. Cl.** **D8/358**

(58) **Field of Search** D8/349, 354, 356,
D8/357, 358, 359; 191/12.2 R; 206/389;
239/195; 242/118, 118.4, 118.6, 118.62,
128, 129, 129.5, 129.51, 129.6, 129.62,
134, 137, 395, 398, 403.1, 405, 405.1,
405.2, 405.3, 407

DESCRIPTION

FIG. 1 is a perspective view of a hose receiving device showing my new design;
FIG. 2 is a front elevational view thereof;
FIG. 3 is a rear elevational view thereof;
FIG. 4 is a top plan view thereof;
FIG. 5 is a bottom plan view thereof;
FIG. 6 is a left side elevational view thereof;
FIG. 7 is a right side elevational view thereof; and,
FIG. 8 is a perspective view thereof, the faucet, the hoses, the other hose receiving devices, and the sprinkler depicted by means of broken lines being for illustrative purposes only and forming no part of the claimed design.

(56) **References Cited**

U.S. PATENT DOCUMENTS

3,617,659 A * 11/1971 Freeman 191/12.2
3,941,331 A * 3/1976 Croullebois 242/118
4,251,038 A * 2/1981 Gename 242/86
4,442,984 A * 4/1984 Bayat 242/398

1 Claim, 5 Drawing Sheets

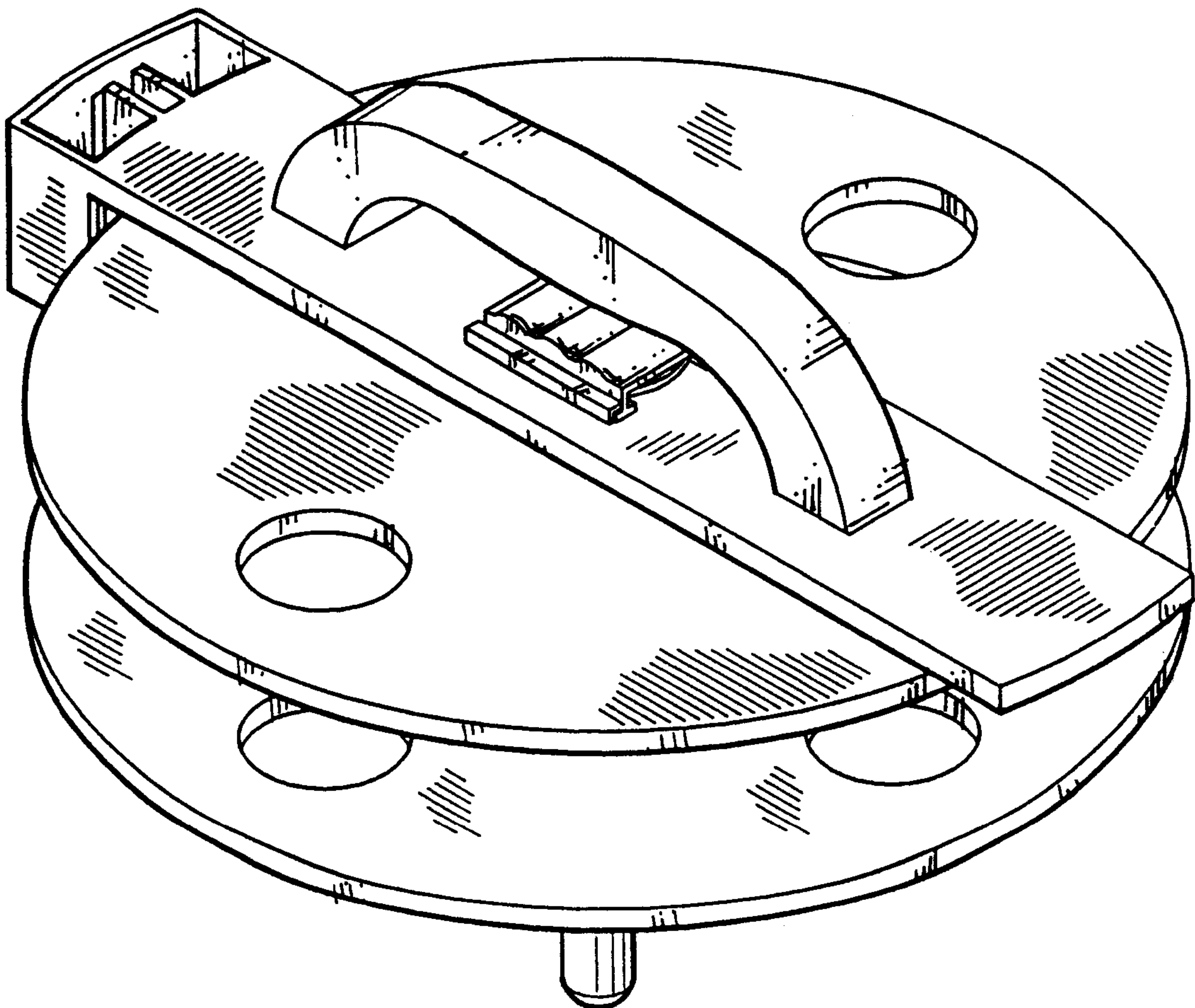

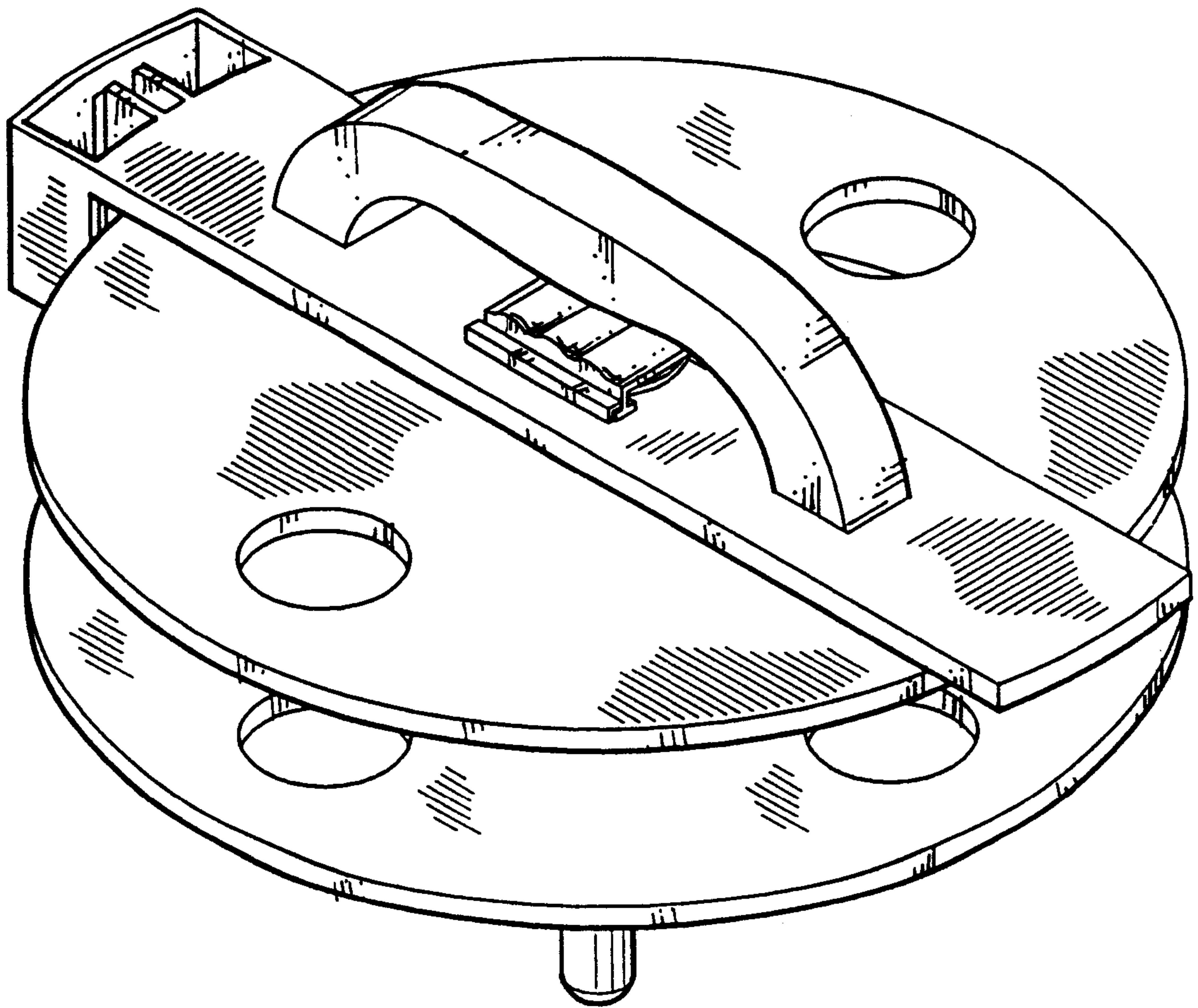

FIG. 1

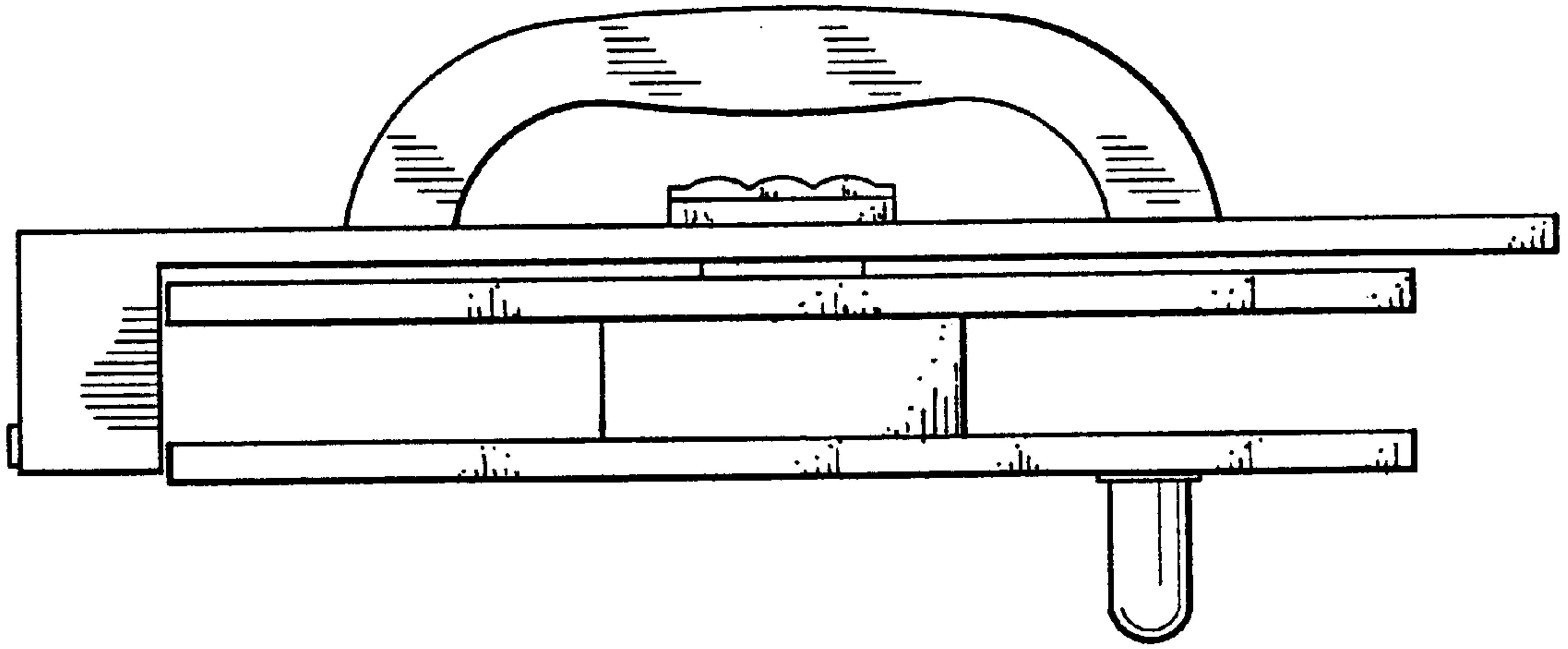

FIG. 2

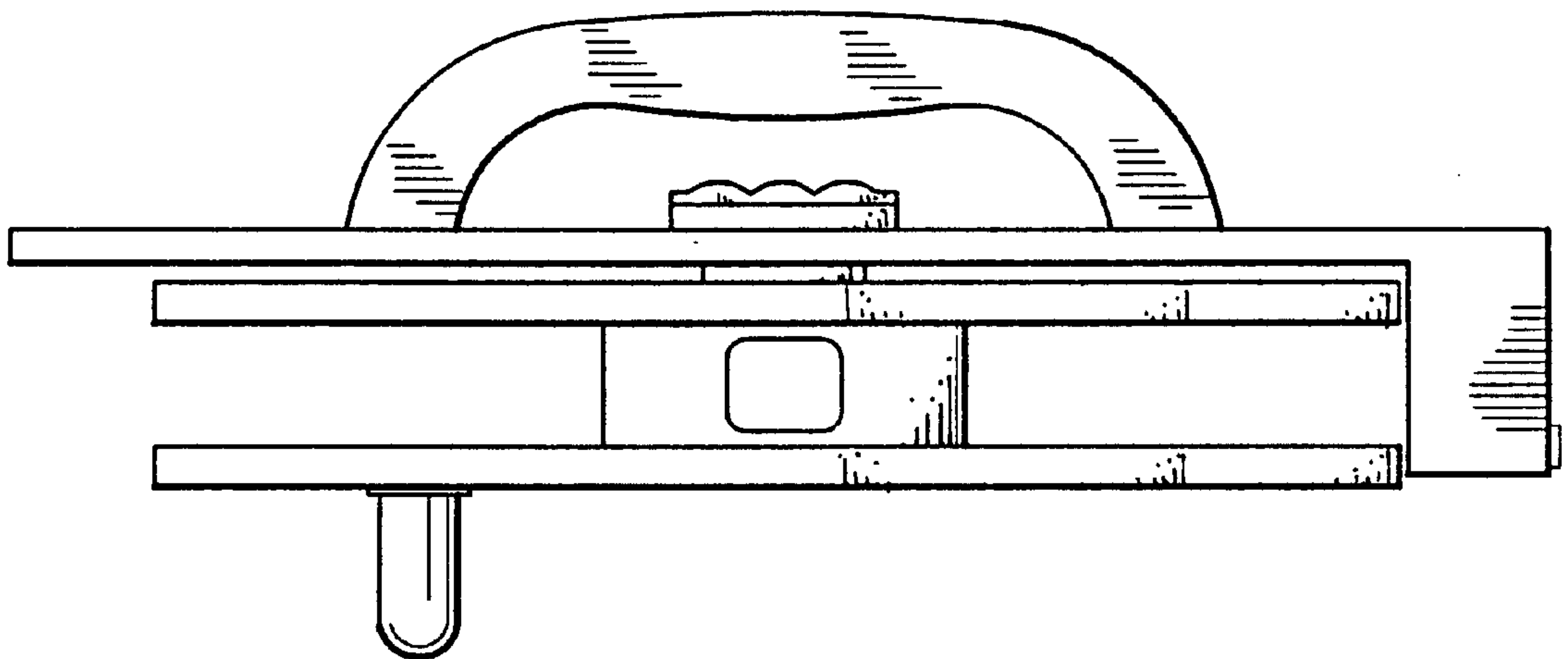

FIG. 3

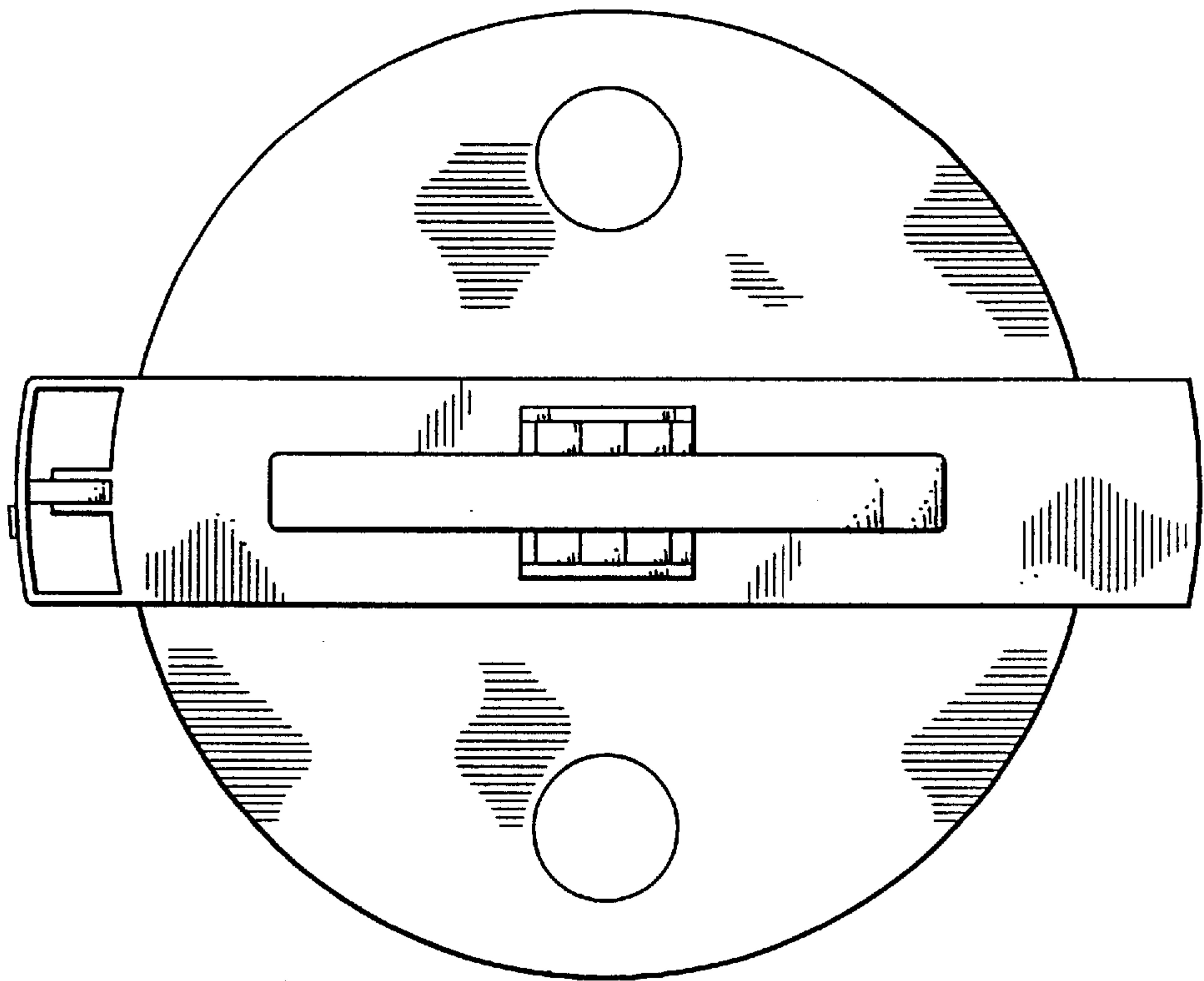

FIG. 4

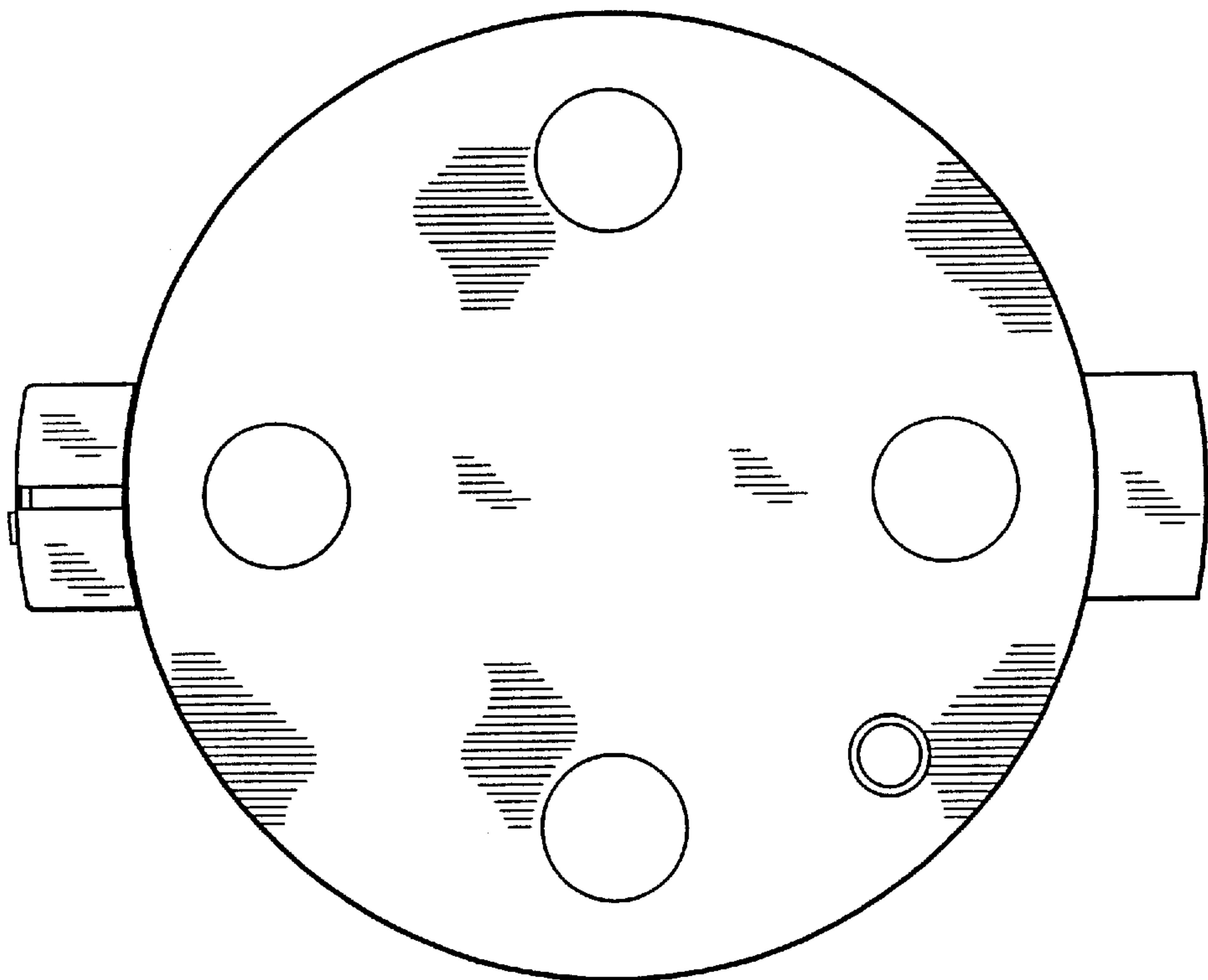

FIG. 5

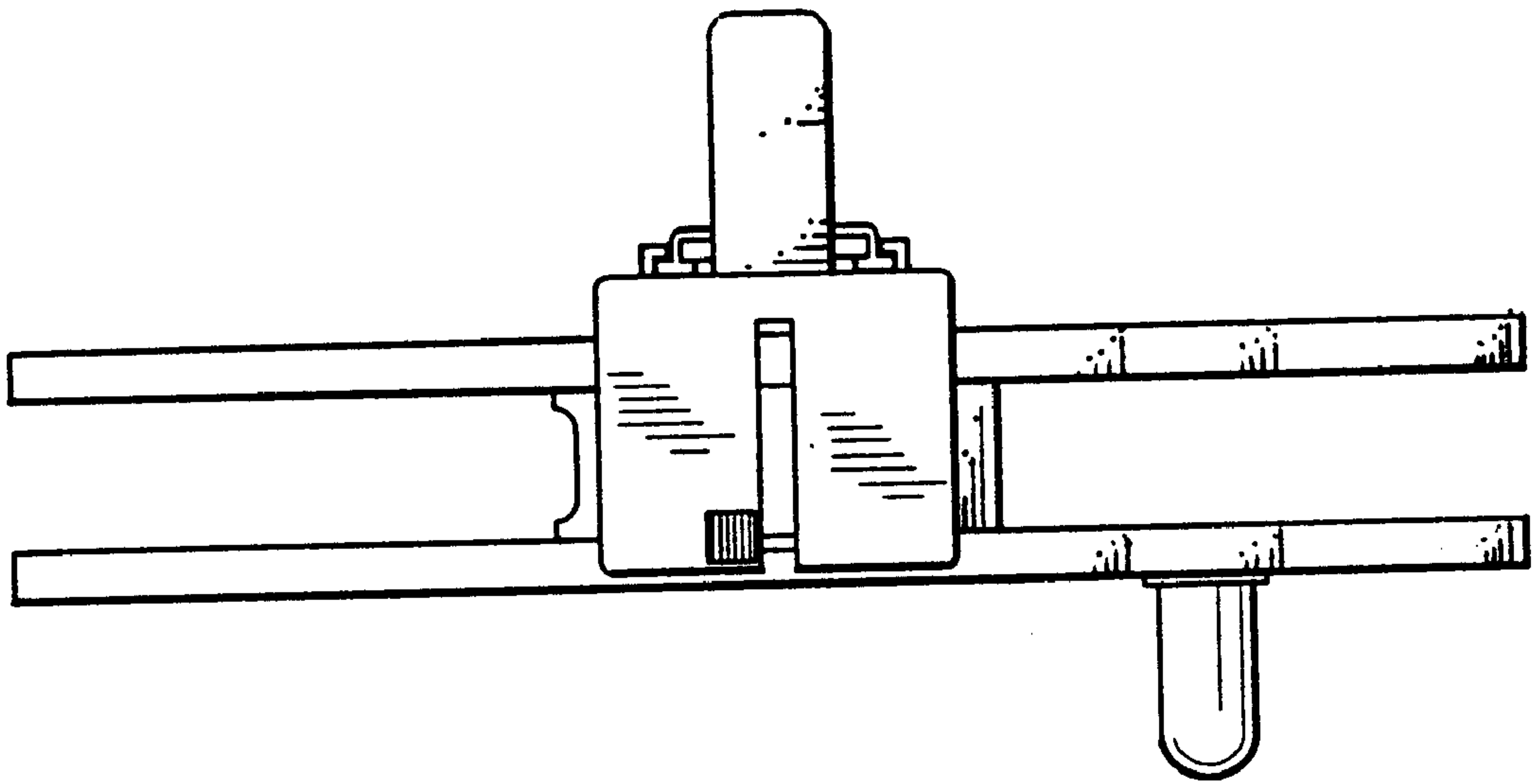

FIG. 6

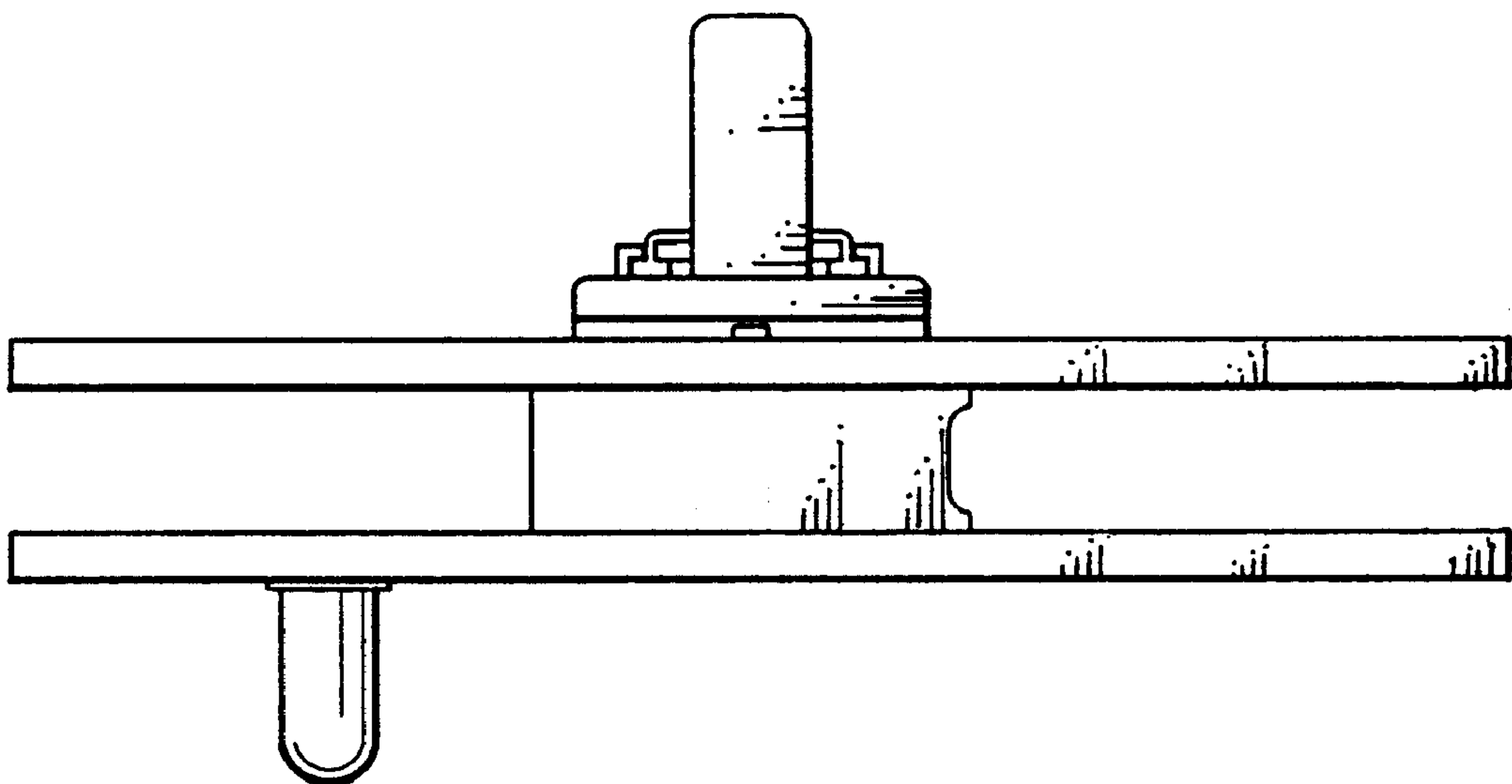

FIG. 7

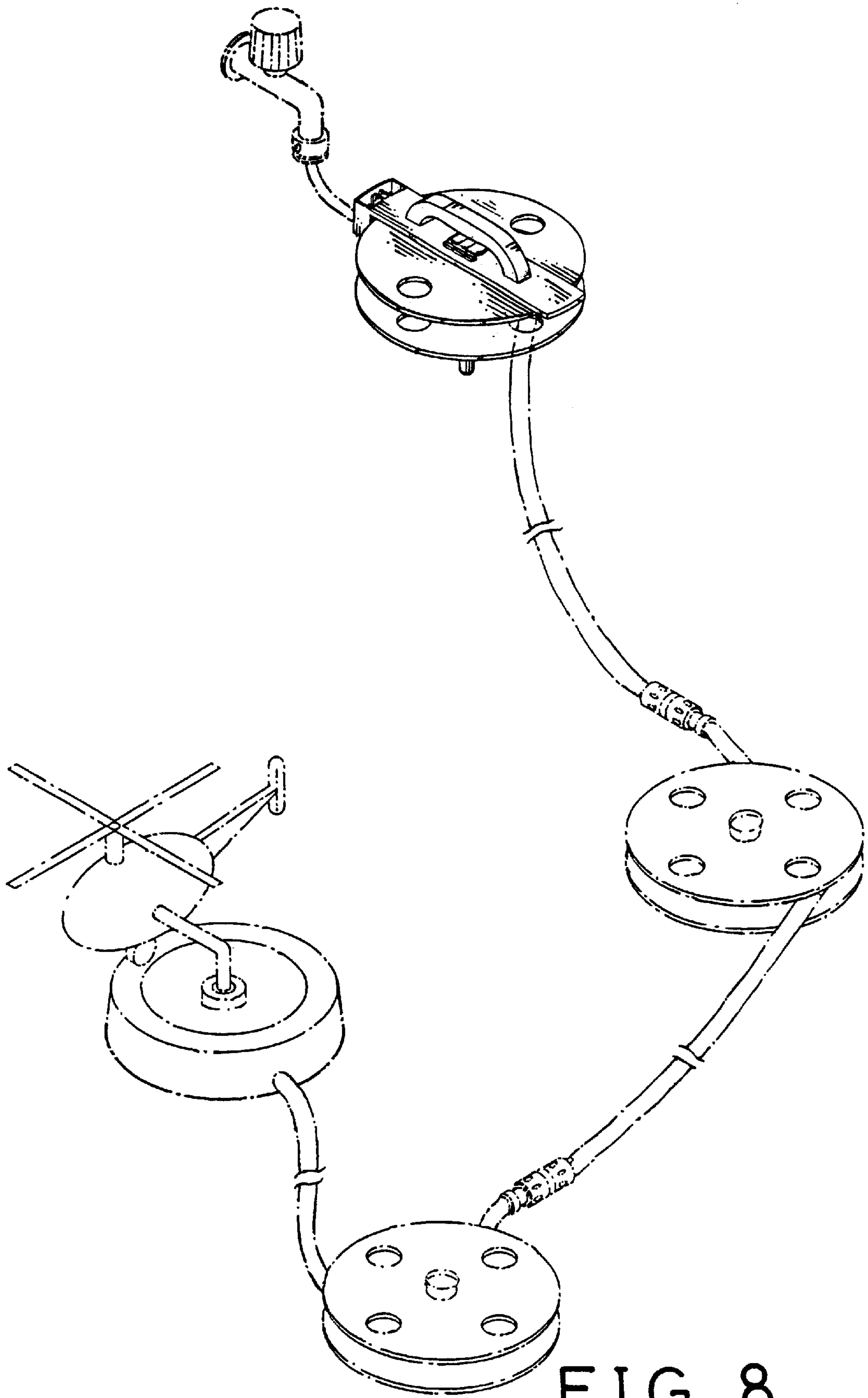

FIG. 8