



US00D458101S

(12) **United States Design Patent**
Hartman et al.

(10) **Patent No.:** **US D458,101 S**

(45) **Date of Patent:** **** Jun. 4, 2002**

(54) **HAND HELD POWER TOOL**

(75) Inventors: **Robert L. Hartman**, Sioux City, IA (US); **Steven C. Carney**, Pleasant Prairie, WI (US); **Isidro M. Alanis**, Sioux City, IA (US); **Scott H. Micoley**, Cedarburg, WI (US)

(73) Assignee: **Snap-on Technologies, Inc.**, Lincolnshire, IL (US)

(**) Term: **14 Years**

(21) Appl. No.: **29/139,743**

(22) Filed: **Apr. 6, 2001**

(51) **LOC (7) Cl.** **08-01**

(52) **U.S. Cl.** **D8/61**

(58) **Field of Search** D8/61, 62, 63, D8/64, 68, 69; D15/122, 127, 132; 81/57.13, 57.14, 52, 54, 121.1; 140/122; 173/179; 408/124, 125, 132, 199

(56) **References Cited**

U.S. PATENT DOCUMENTS

D315,282 S	*	3/1991	Schmidt et al.	D8/68
D377,442 S	*	1/1997	Kikuchi	D8/68
D414,093 S	*	9/1999	Zurwelle	D8/61
D428,320 S	*	7/2000	Ohi et al.	D8/61

D429,134 S	*	8/2000	Schultz et al.	D8/61
6,102,632 A	*	8/2000	Potter et al.	408/124
D440,850 S	*	4/2001	Ozawa et al.	D8/68
D446,704 S	*	8/2001	Shibata et al.	D8/68

OTHER PUBLICATIONS

Brochure for Festo Tooltechnic CDD9.6ES CDD 12 ES, undated.

* cited by examiner

Primary Examiner—Doris V. Coles

Assistant Examiner—Elizabeth Albert

(74) *Attorney, Agent, or Firm*—Seyfarth Shaw

(57) **CLAIM**

The ornamental design for the hand held power tool, as shown and described.

DESCRIPTION

FIG. 1 is a perspective view of the hand held power tool showing our new design;

FIG. 2 is a front elevational view thereof;

FIG. 3 is a rear elevational view thereof;

FIG. 4 is a side elevational view of one side thereof;

FIG. 5 is a top plan view thereof; and

FIG. 6 is side elevational view of the other side thereof; and,

FIG. 7 is a bottom plan view.

1 Claim, 3 Drawing Sheets

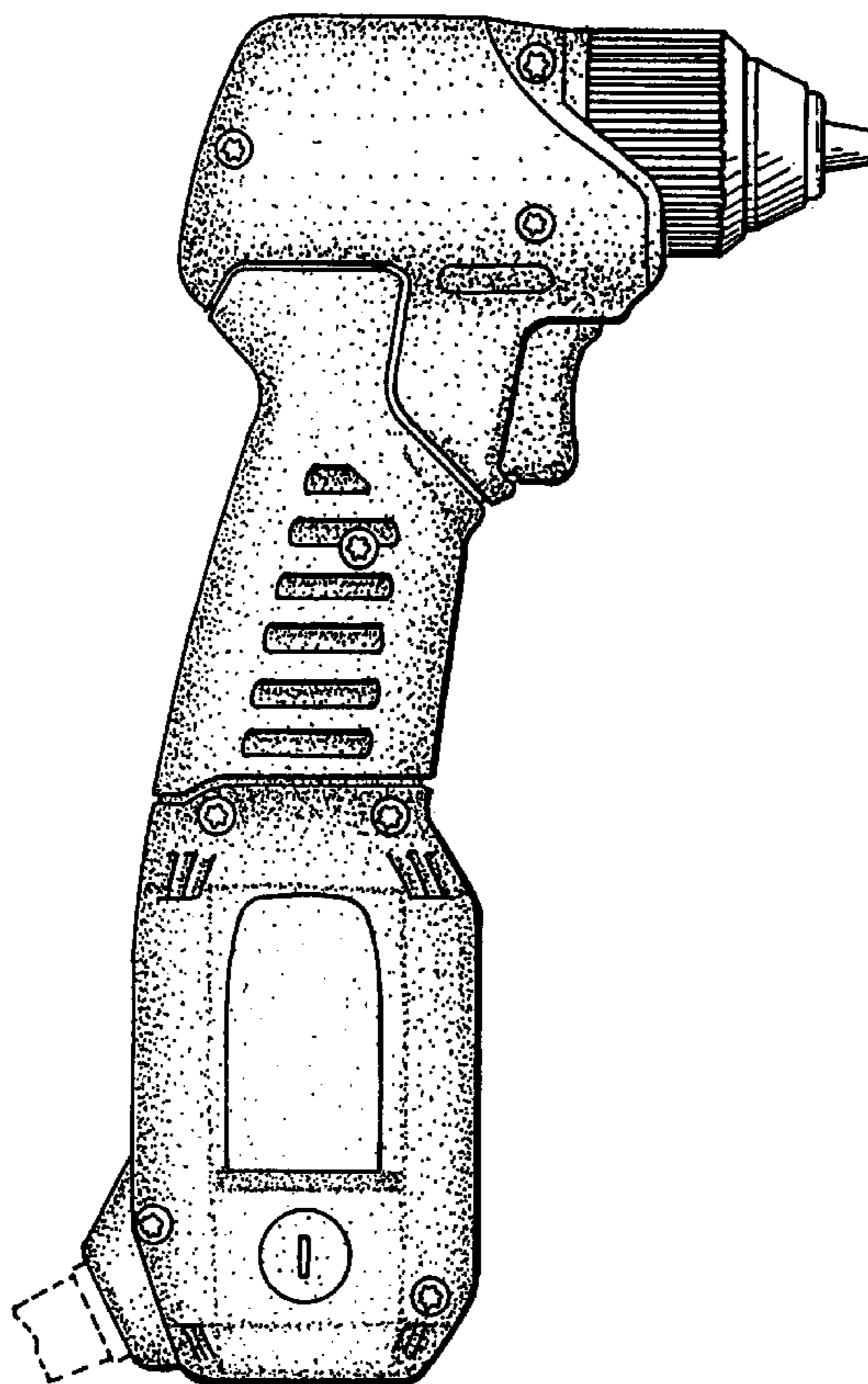

FIG.1

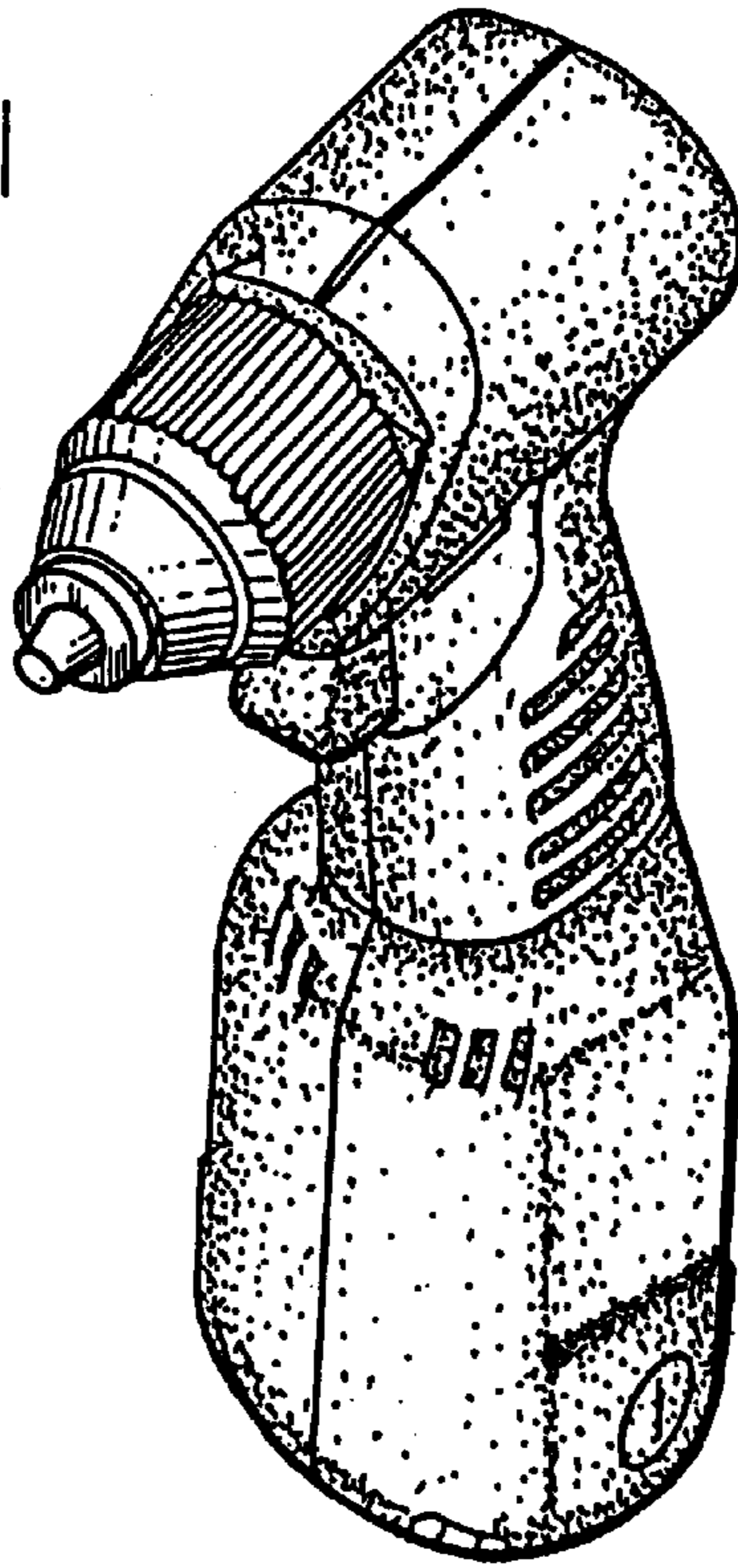

FIG.3

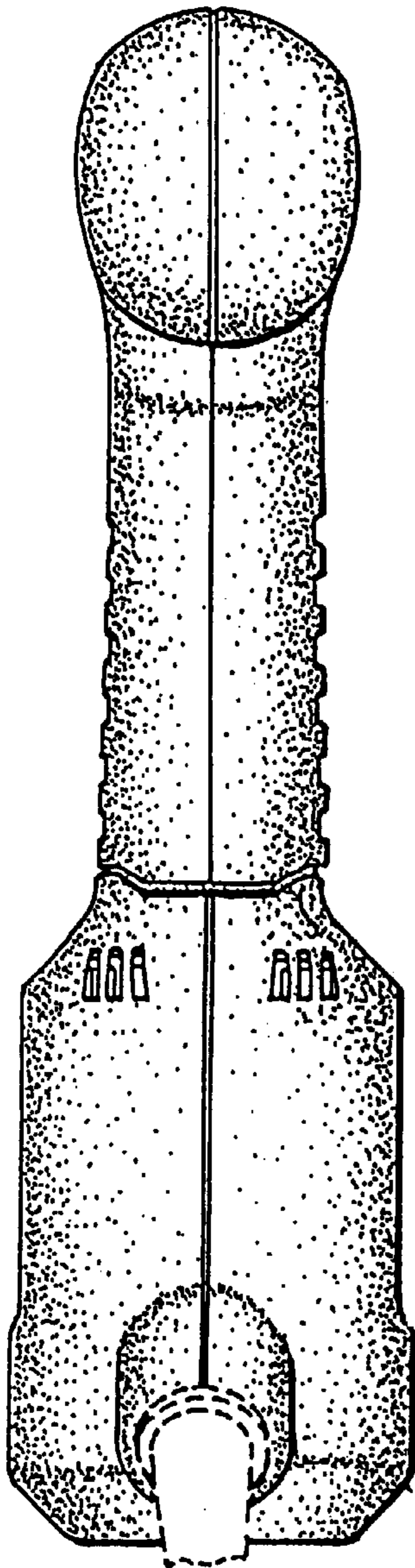

FIG.2

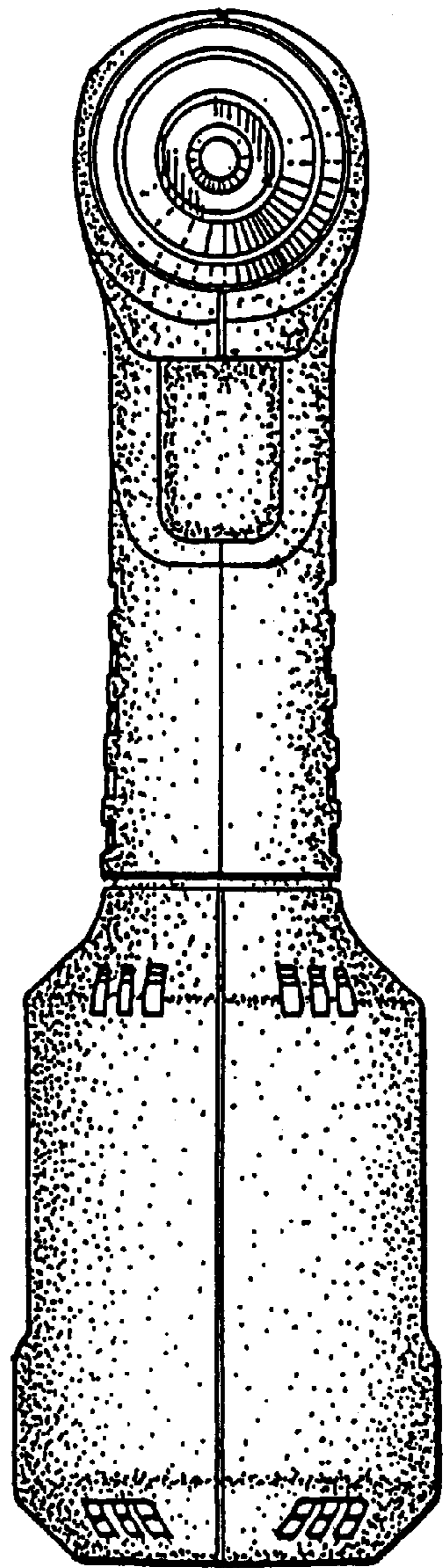

FIG. 4

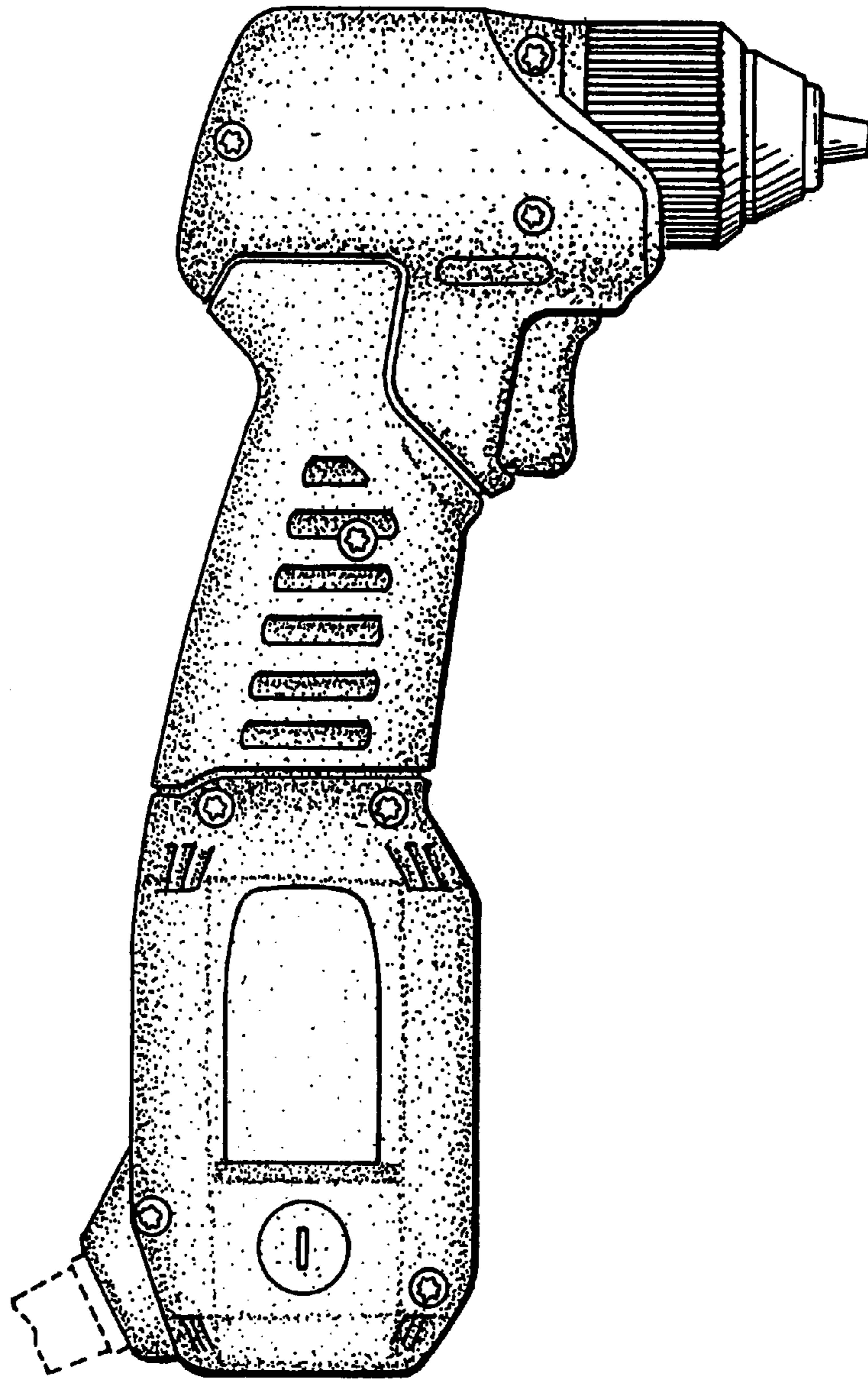

FIG. 5

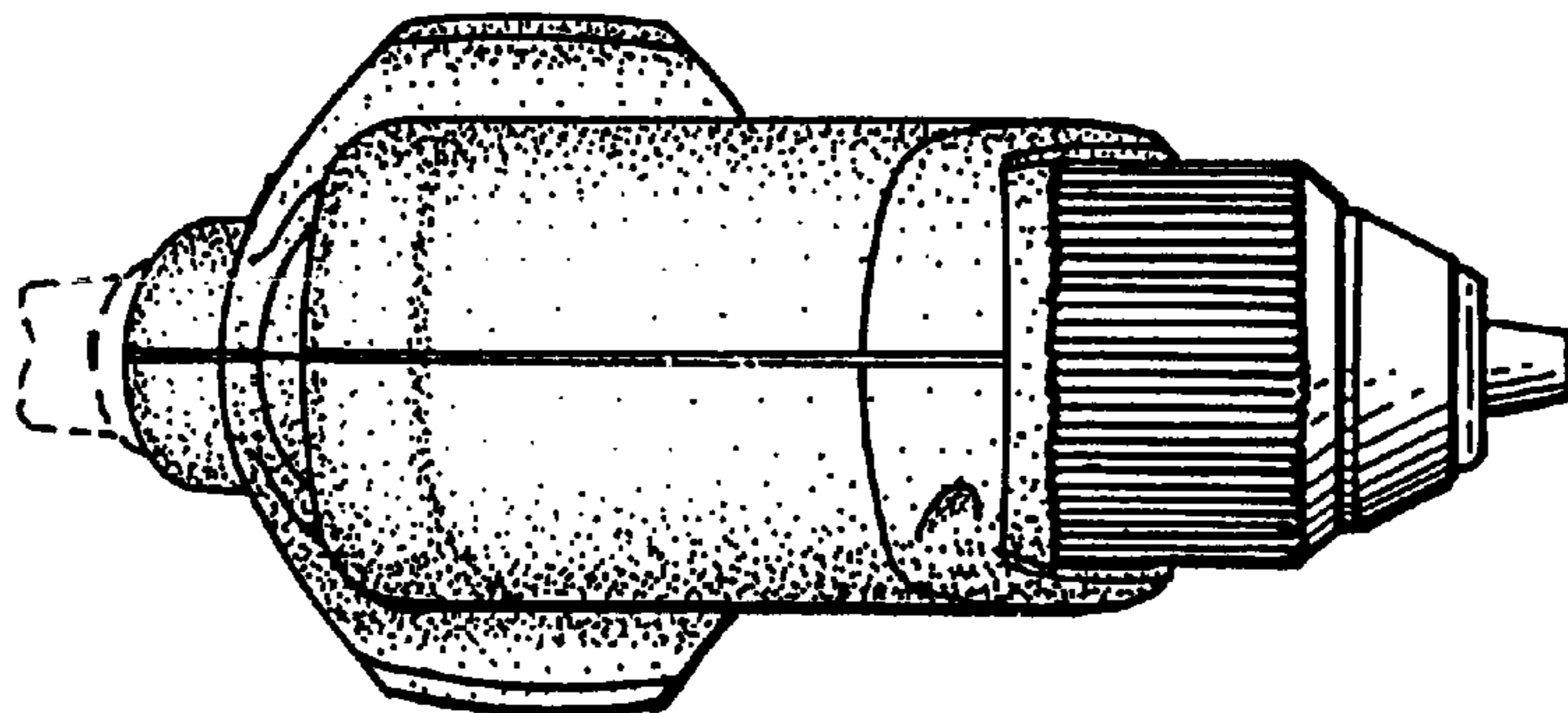

FIG.6

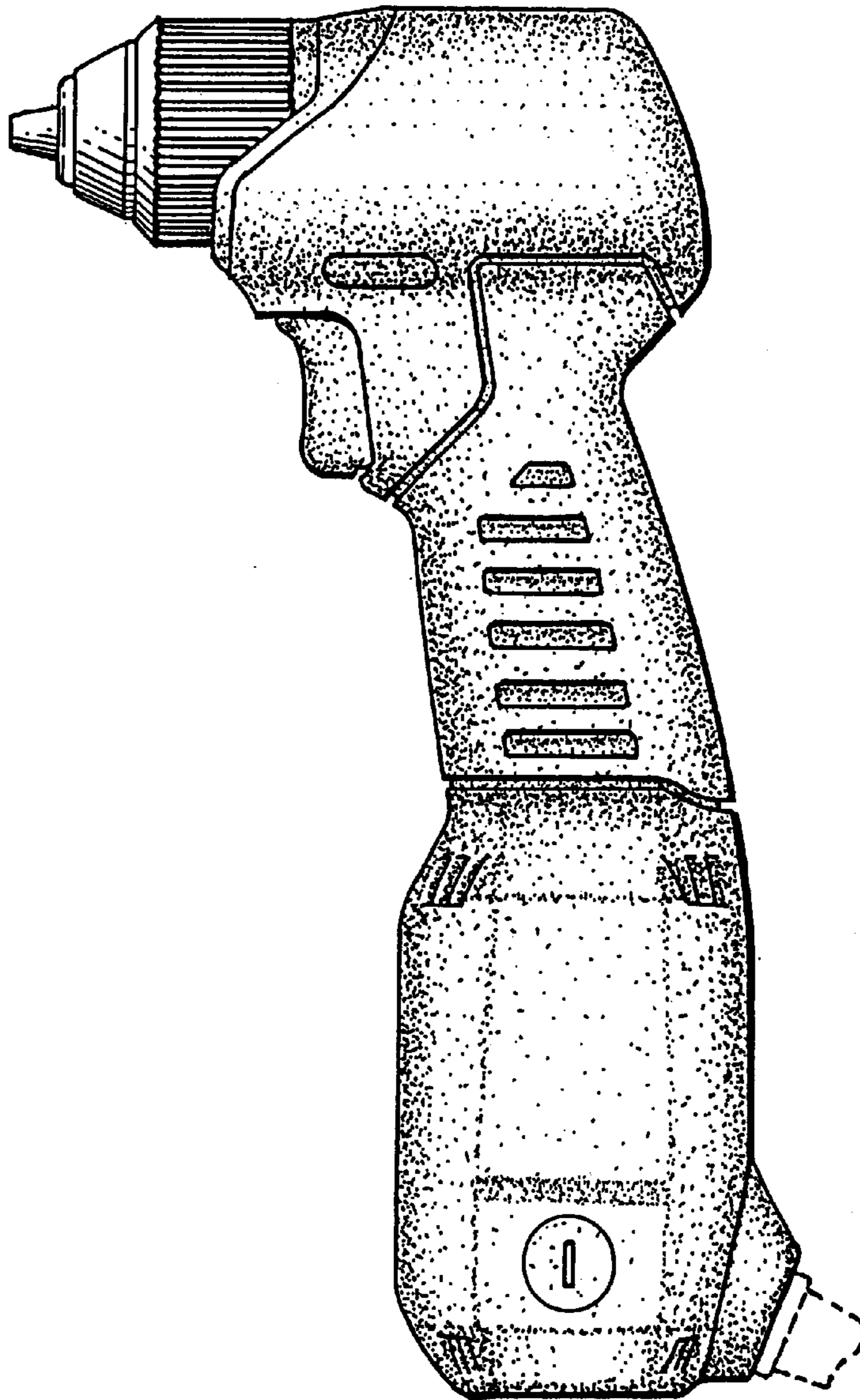

FIG.7

