



US00D458025S

(12) **United States Design Patent**  
**Tuerschmann et al.**

(10) **Patent No.:** **US D458,025 S**

(45) **Date of Patent:** **\*\* Jun. 4, 2002**

(54) **GOLF BAG STORAGE POCKET**

6,202,840 B1 \* 3/2001 Cahng ..... 206/315.2

(75) Inventors: **Gary L. Tuerschmann**, Phoenix; **Ryan Larson**, Scottsdale, both of AZ (US)

\* cited by examiner

*Primary Examiner*—Prabhakar Deshmukh

(73) Assignee: **Karsten Manufacturing Corporation**, Phoenix, AZ (US)

(74) *Attorney, Agent, or Firm*—Darrell F. Marquette

(\*\*) Term: **14 Years**

(57) **CLAIM**

The ornamental design for a golf bag storage pocket, as shown and described.

(21) Appl. No.: **29/139,304**

**DESCRIPTION**

(22) Filed: **Mar. 28, 2001**

(51) **LOC (7) Cl.** ..... **03-99**

(52) **U.S. Cl.** ..... **D3/320**

(58) **Field of Search** ..... D3/318, 319, 320,  
D3/328, 328.1, 904; 206/315.2–315.5; 224/901,  
918

FIG. 1 is a front elevational view of a golf bag storage pocket showing our new design;

FIG. 2 is a side elevational view of the golf bag storage pocket taken from the left in FIG. 1;

FIG. 3 is a side elevational view of the golf bag storage pocket taken from the right in FIG. 1;

FIG. 4 is a bottom view of the golf bag storage pocket of FIG. 1;

FIG. 5 is a top view of the golf bag storage pocket of FIG. 1; and,

FIG. 6 is a rear elevational view of the golf bag storage pocket of FIG. 1.

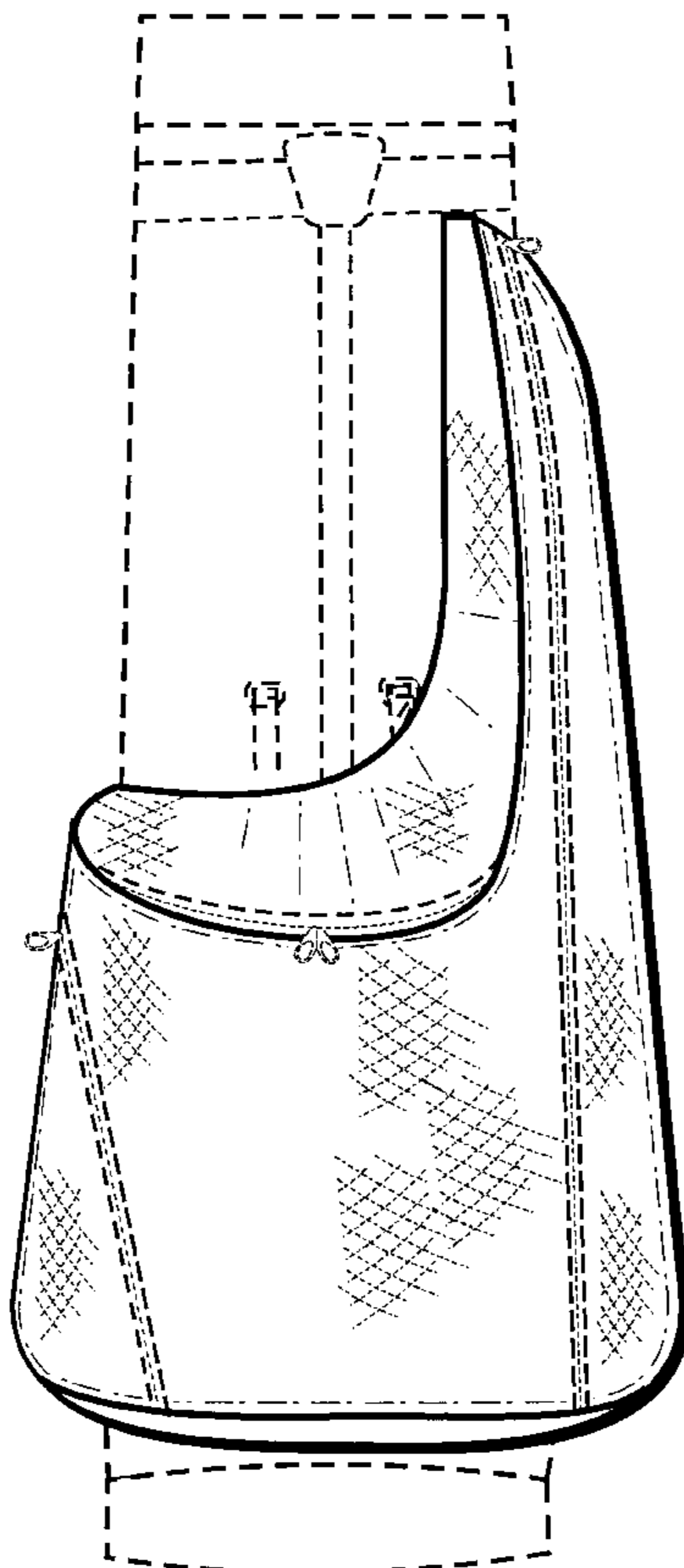
The broken line showing of portions of a golf bag is for illustrative purposes only and forms no part of the claimed design.

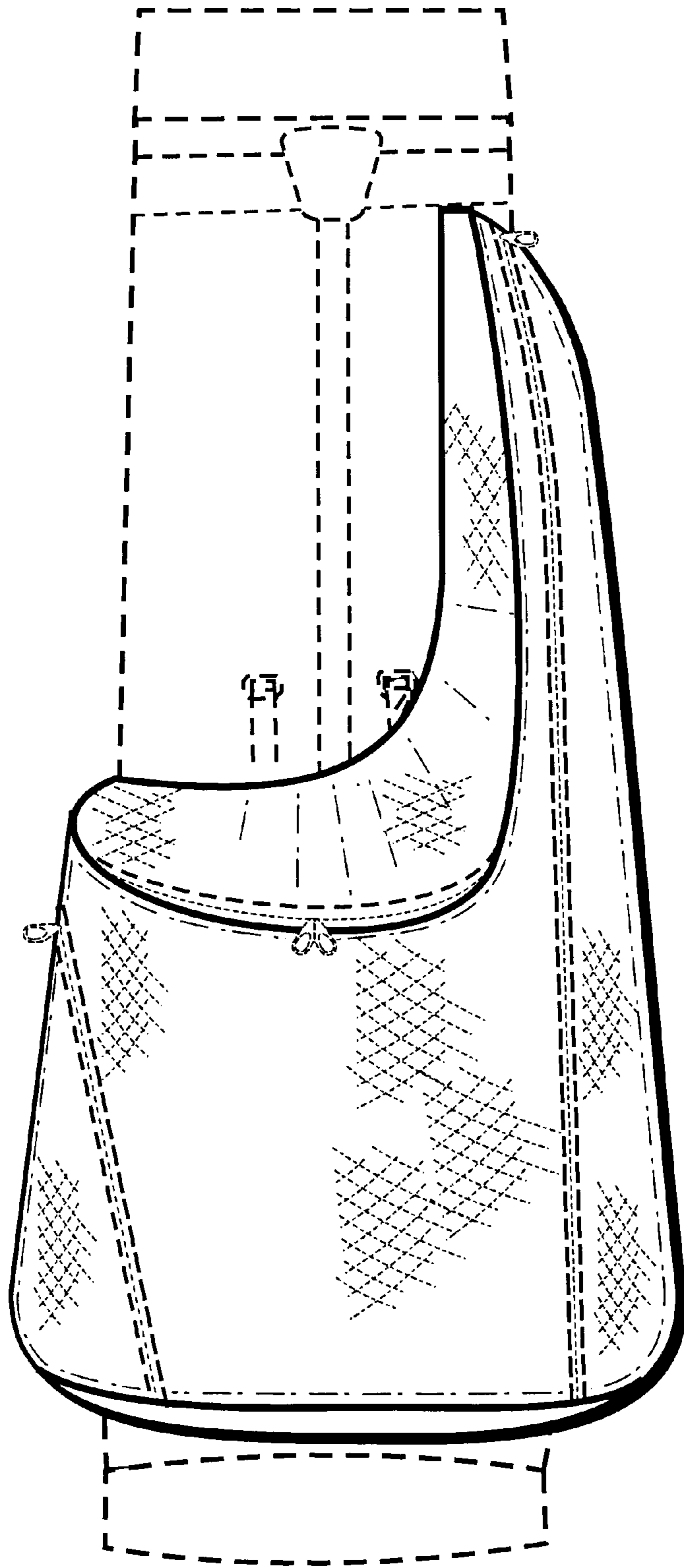
(56) **References Cited**

**U.S. PATENT DOCUMENTS**

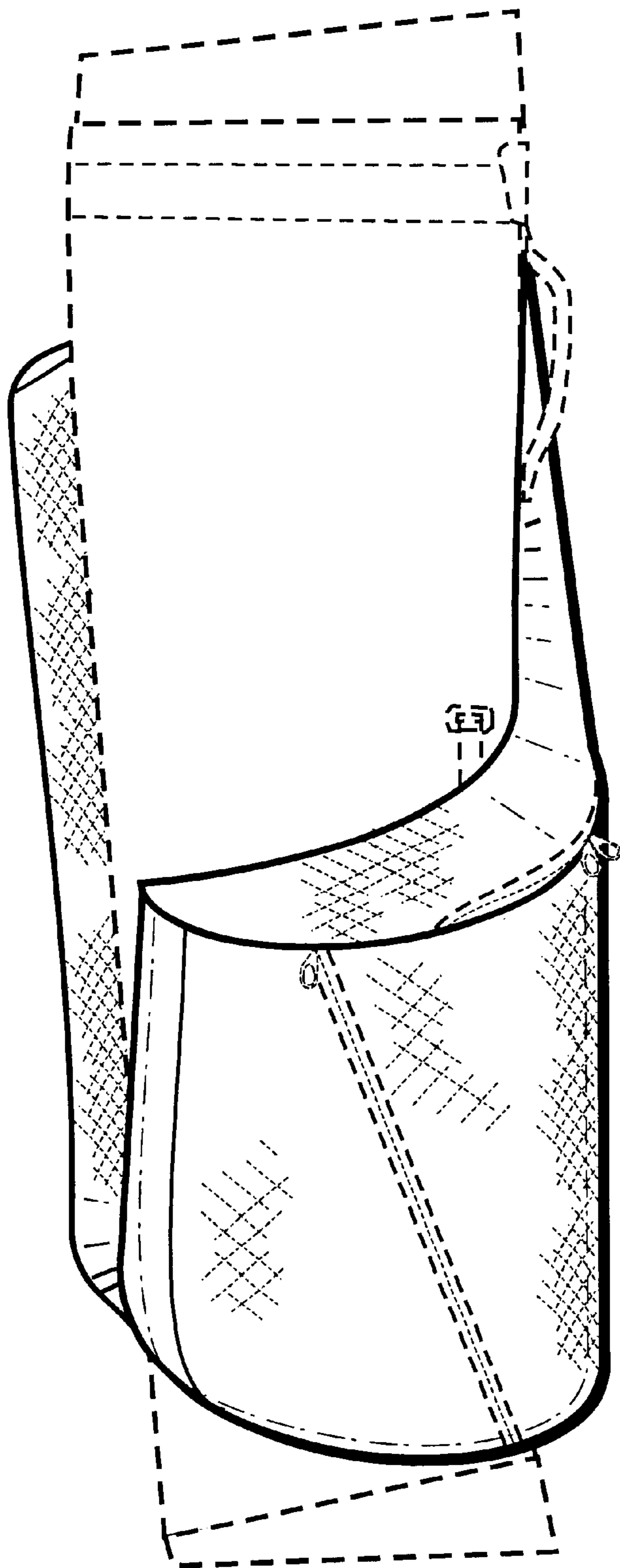
D213,010 S	*	12/1968	Penna	.....	D3/320
D292,843 S	*	11/1987	Frezza	.....	D3/904
5,004,100 A	*	4/1991	Smith	.....	206/315.2
5,176,253 A	*	1/1993	Perrin et al.	.....	206/315.5
5,402,883 A	*	4/1995	Shin	.....	206/315.5
D372,126 S	*	7/1996	Martinez et al.	.....	D3/320
5,566,825 A	*	10/1996	Price	.....	206/315.5
D383,899 S	*	9/1997	Rhee	.....	D3/320

**1 Claim, 5 Drawing Sheets**

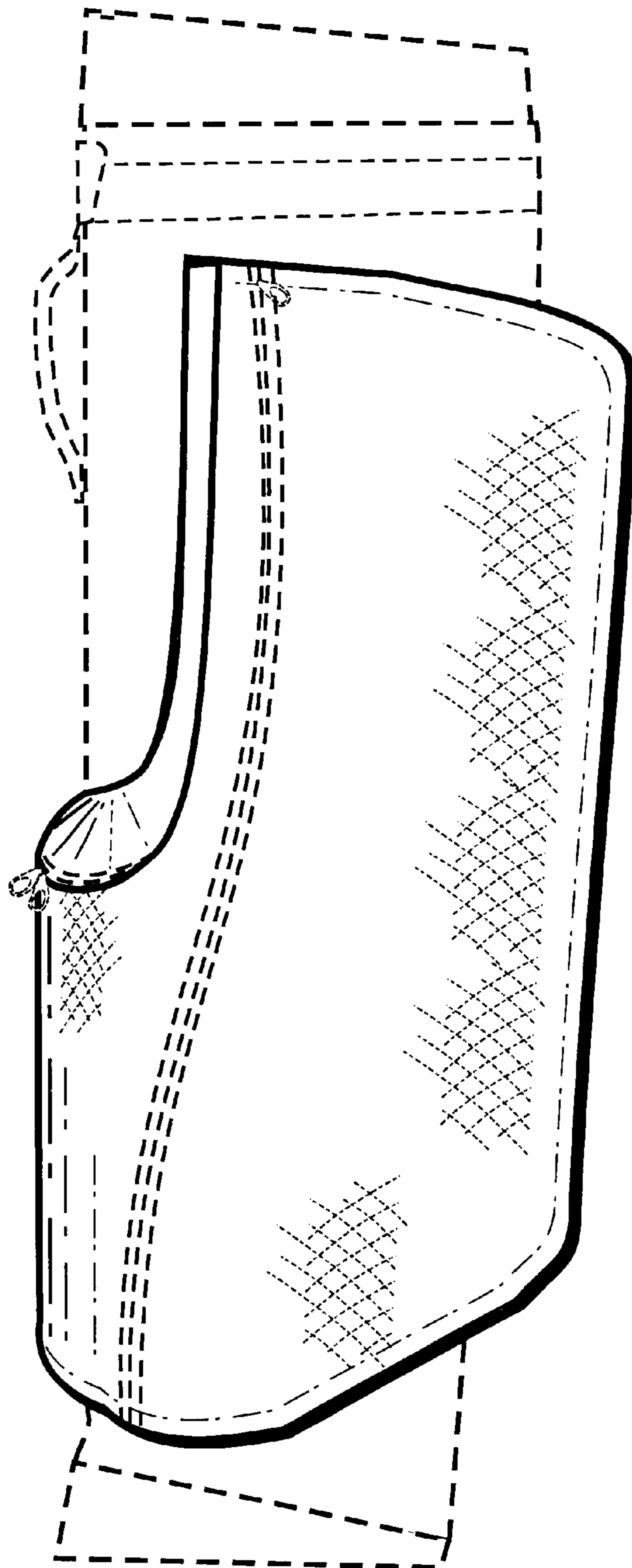




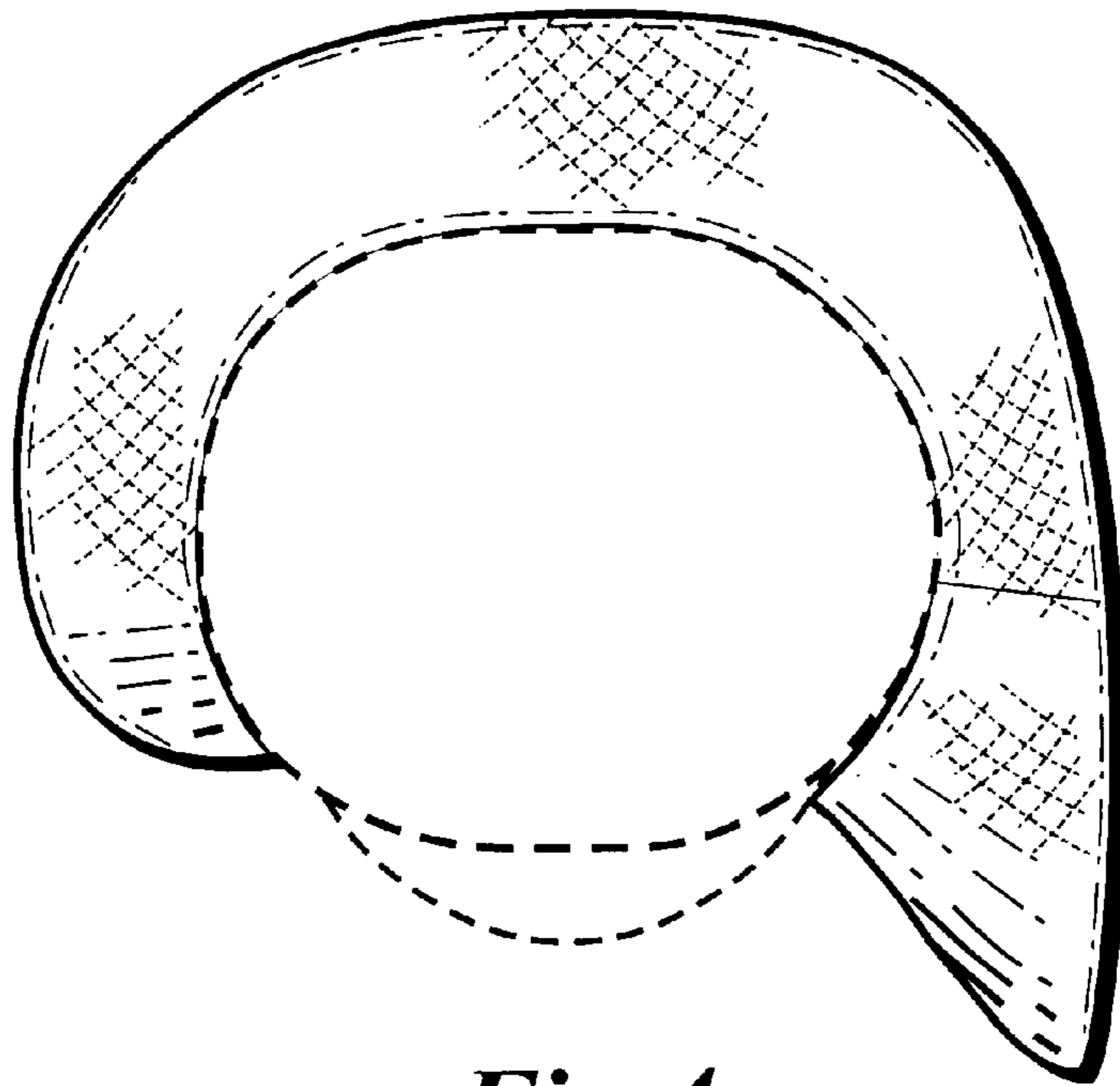
*Fig.1*



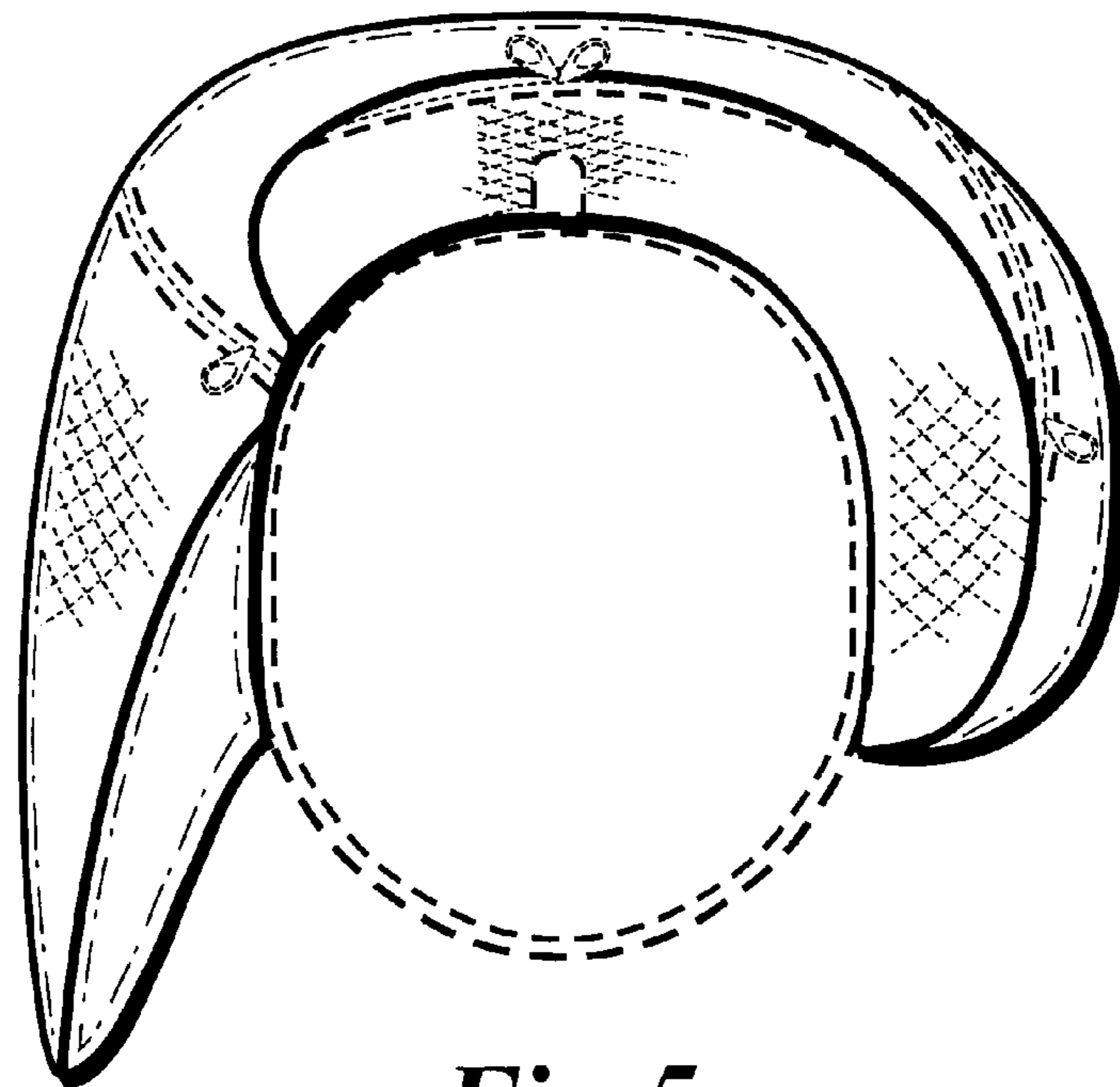
*Fig. 2*



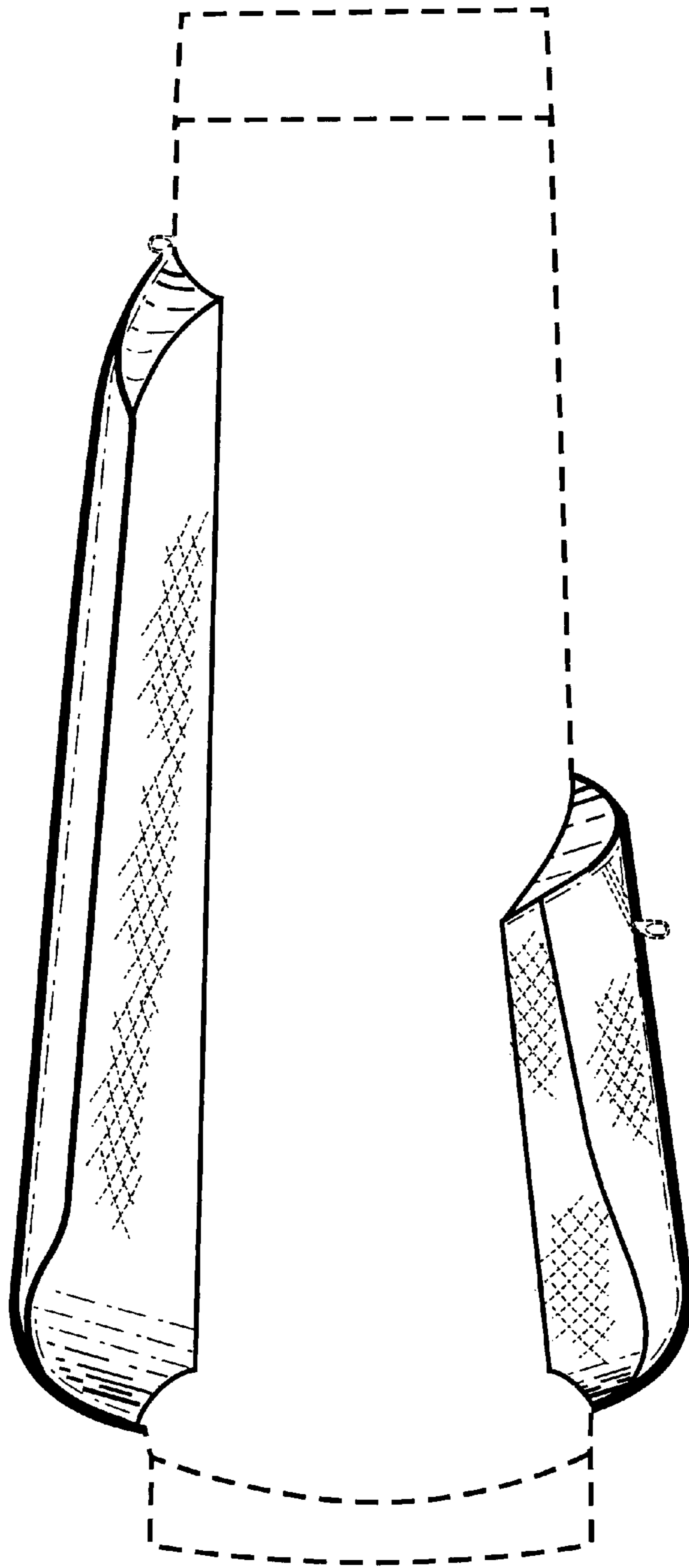
*Fig. 3*



*Fig. 4*



*Fig. 5*



*Fig. 6*