



US00D457923S

(12) **United States Design Patent**
LeCoultre

(10) **Patent No.:** **US D457,923 S**

(45) **Date of Patent:** **** May 28, 2002**

(54) **DESK TOP TOY**

6,241,248 B1 * 6/2001 Winter 273/153 S

(75) Inventor: **Lysander LeCoultre**, Boston, MA (US)

* cited by examiner

(73) Assignee: **Teleknowledge Group LTD**, Kfar Saba (IL)

Primary Examiner—Dominic Simone

(74) *Attorney, Agent, or Firm*—Martin Fleit; Paul D. Bianco

(**) Term: **14 Years**

(57) **CLAIM**

(21) Appl. No.: **29/130,587**

The ornamental design for a desk top toy, as shown and described.

(22) Filed: **Oct. 3, 2000**

DESCRIPTION

(51) **LOC (7) Cl.** **21-02**

(52) **U.S. Cl.** **D21/479**

(58) **Field of Search** D11/131; D21/478, D21/479; 273/153 R, 153 S, 156

FIG. 1 is a front view of the desk top toy showing its new design;

FIG. 2 is a top view of the desk top toy shown in FIG. 1;

FIG. 3 is a right side view of the desk top toy shown in FIG. 1;

FIG. 4 is a left side view of the desk top toy shown in FIG. 1;

FIG. 5 is a rear view of the desk top toy shown in FIG. 1;

FIG. 6 is a bottom view of the desk top toy shown in FIG. 1; and,

FIG. 7 is a perspective view of the desk top toy shown in FIG. 1.

(56) **References Cited**

U.S. PATENT DOCUMENTS

D121,007 S	*	6/1940	Boyle	D21/479
2,714,511 A	*	8/1955	Derrig	273/153 R
D232,959 S	*	9/1974	Scott	D21/478
D237,640 S	*	11/1975	Baynes	D21/478
D237,642 S	*	11/1975	Baynes	D21/479
D307,452 S	*	4/1990	Laubxcher	D21/479
5,125,661 A	*	6/1992	Jarboe	273/156
D359,770 S	*	6/1995	Connelley	D21/479

1 Claim, 4 Drawing Sheets

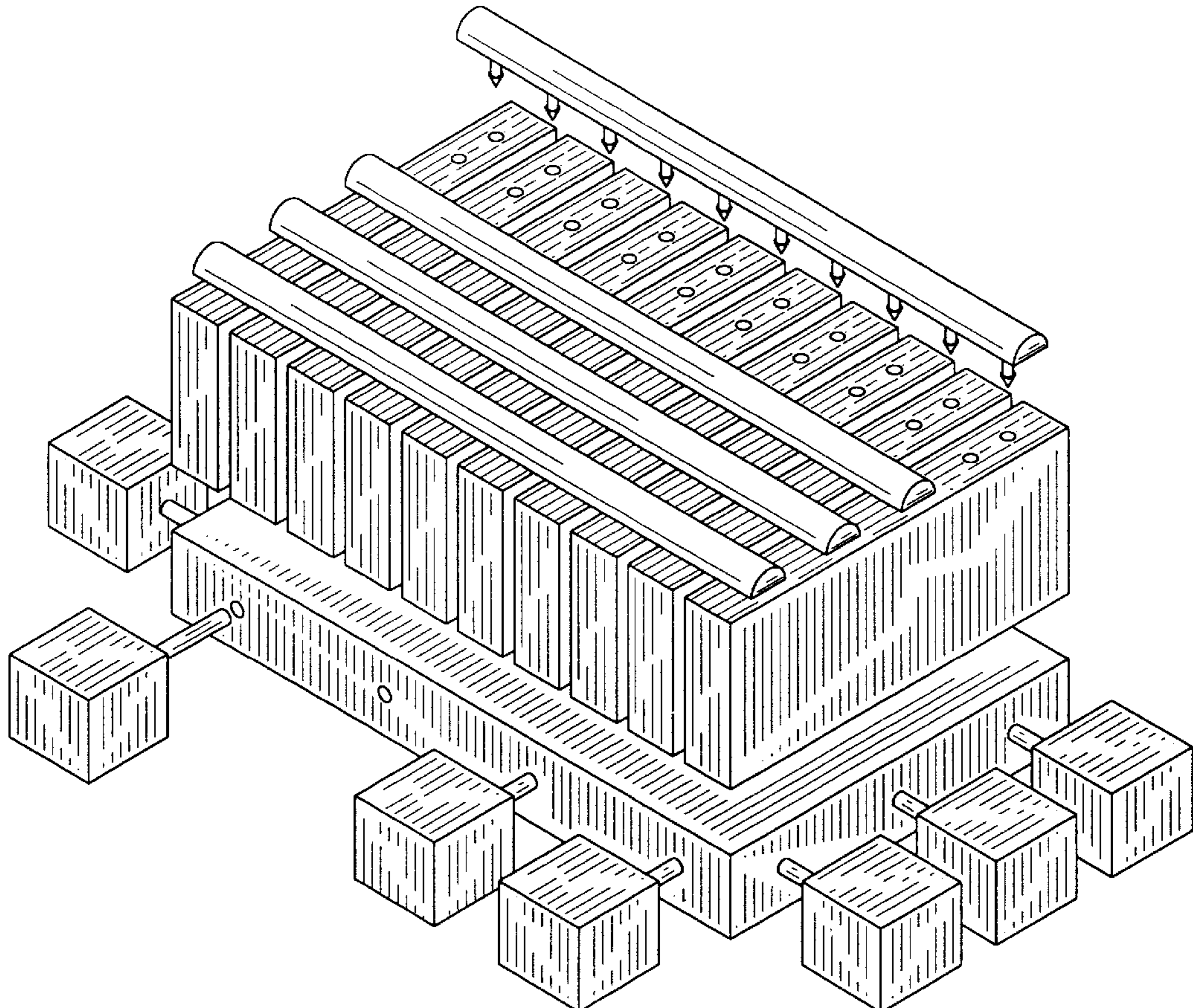

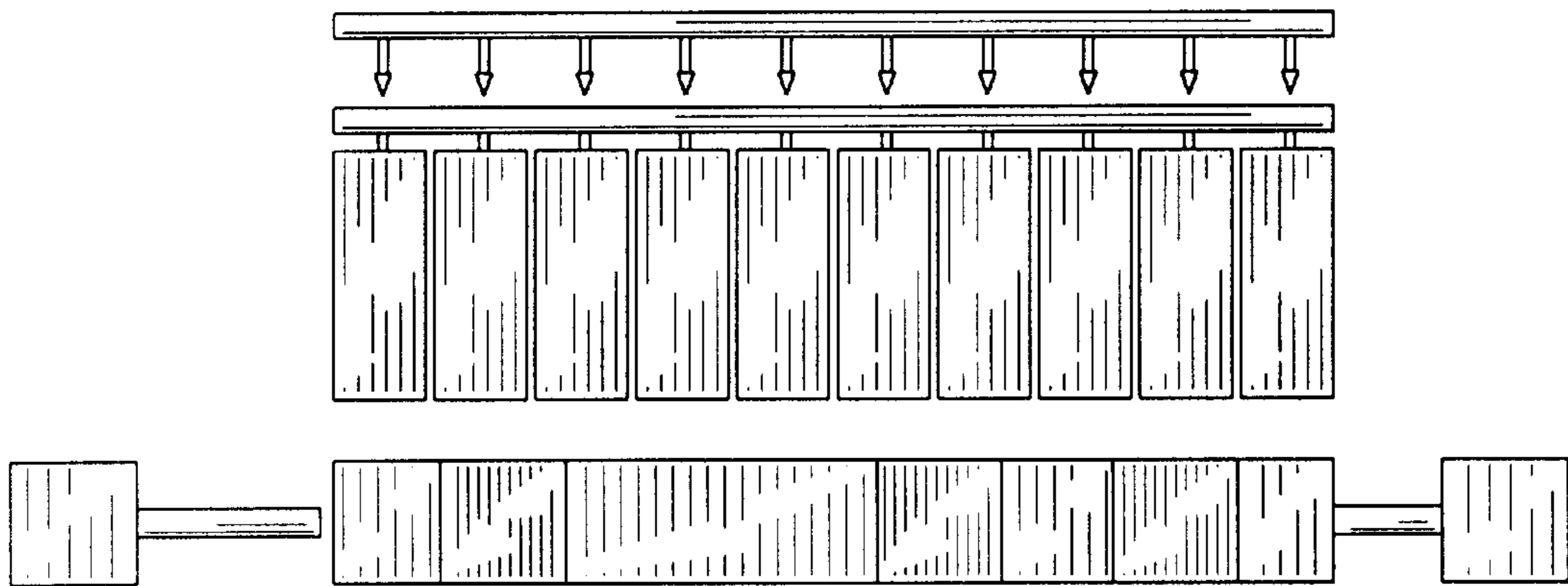

FIG.1

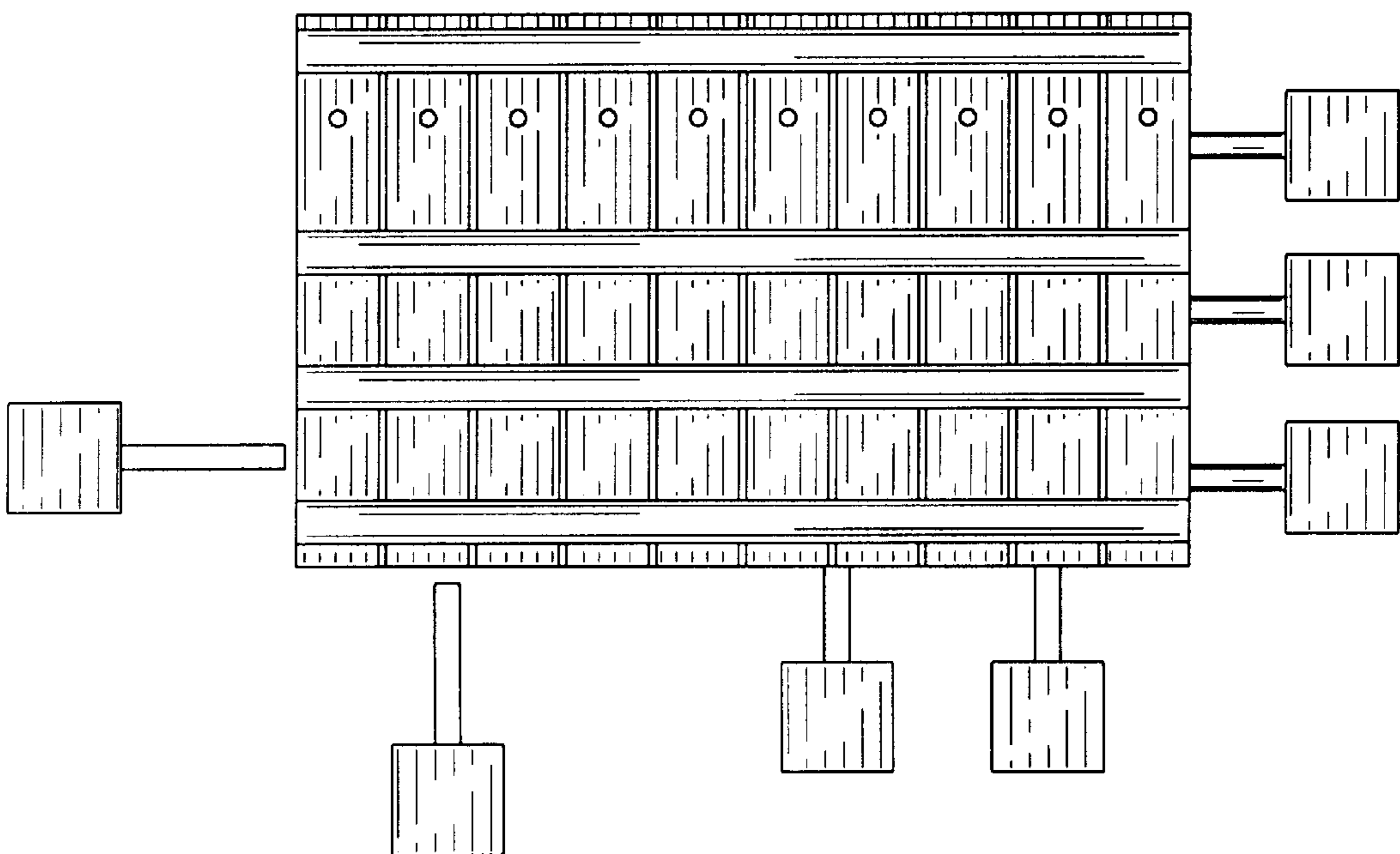

FIG.2

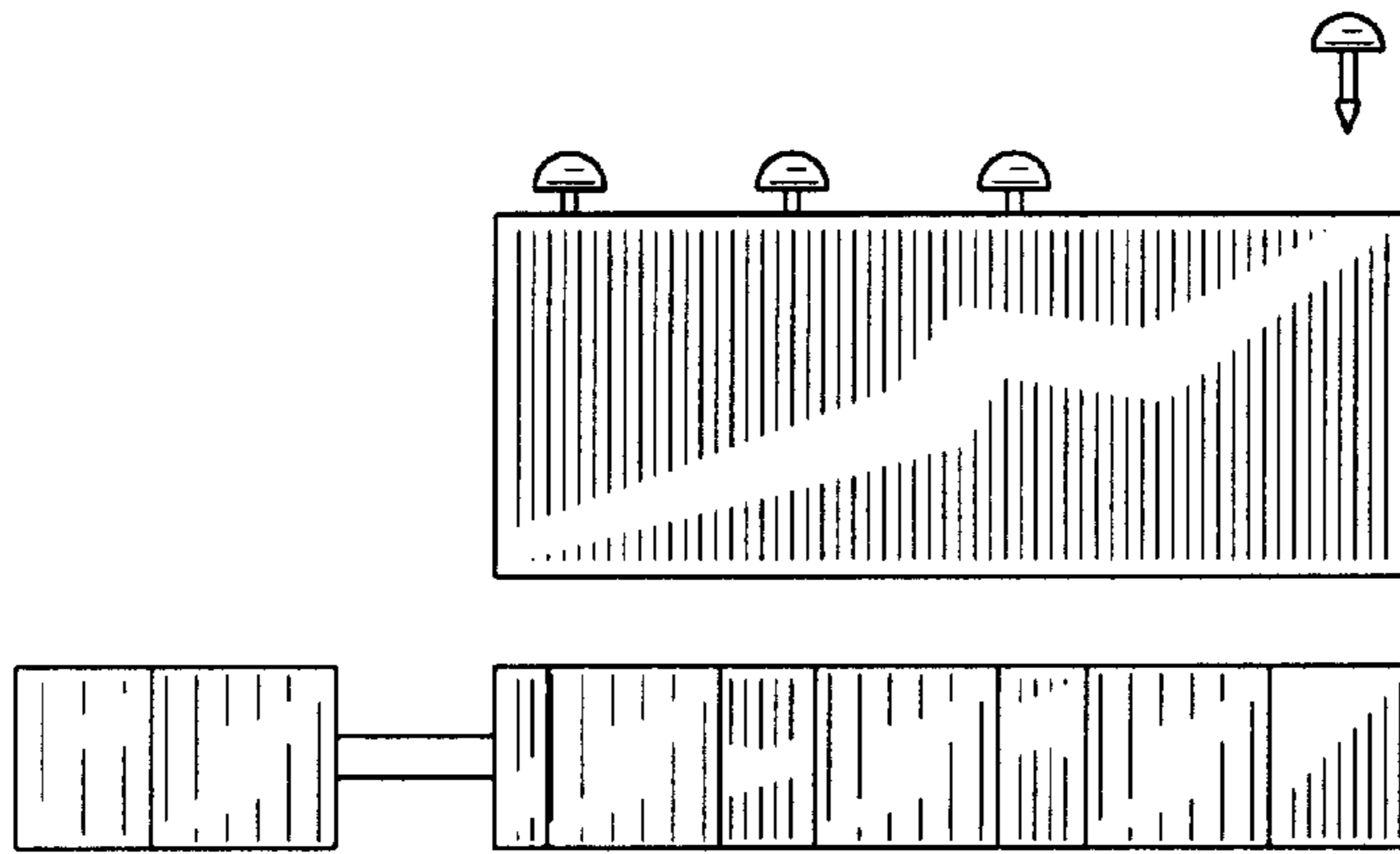

FIG. 3

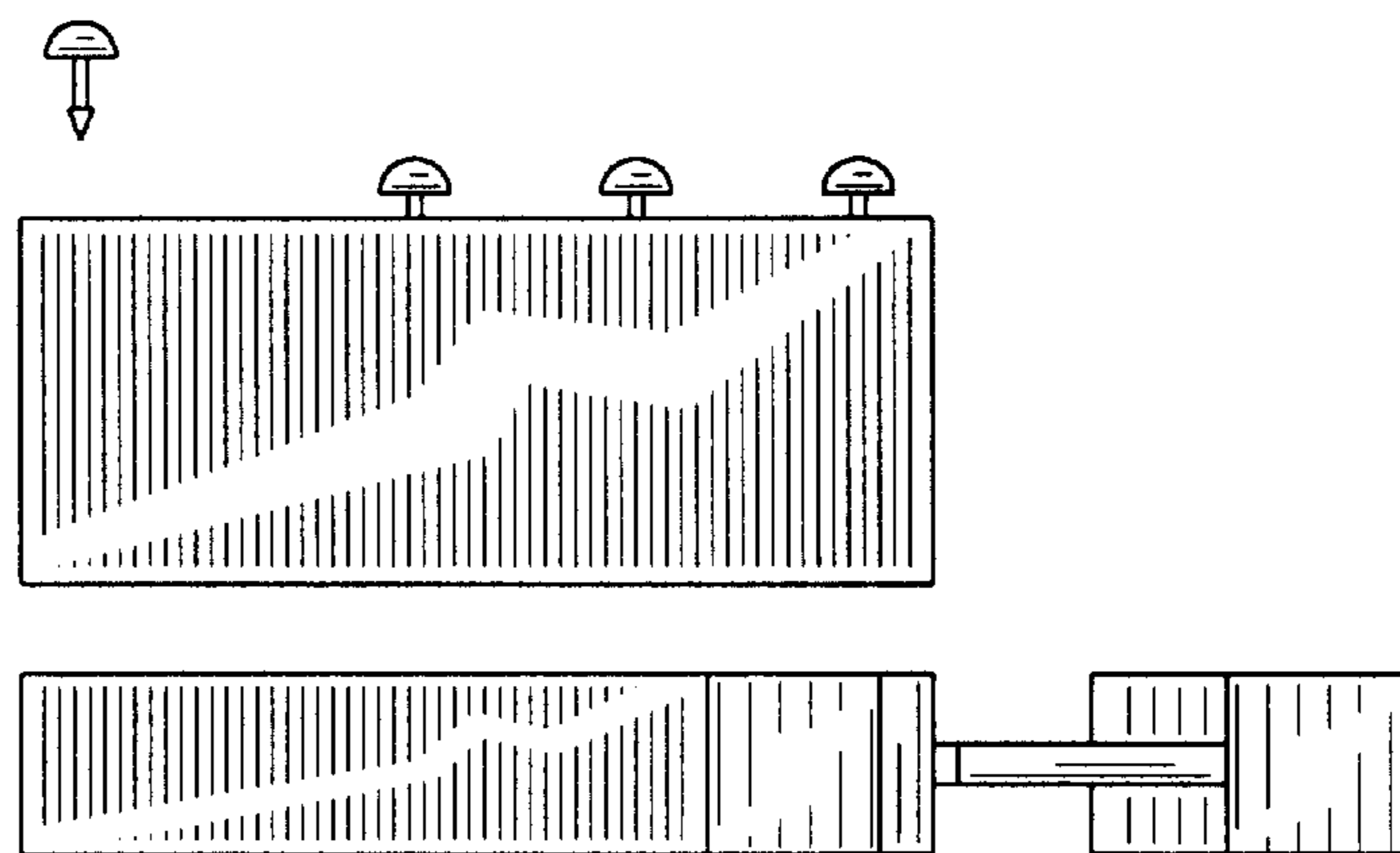

FIG. 4

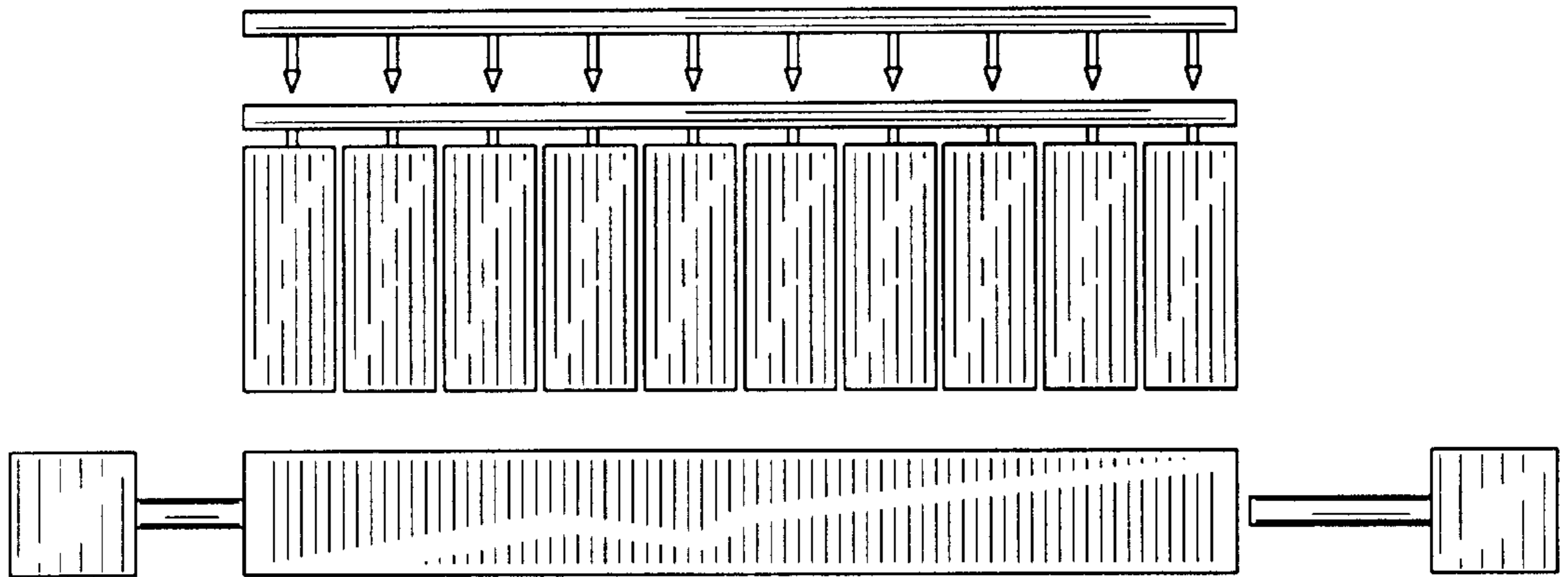

FIG. 5

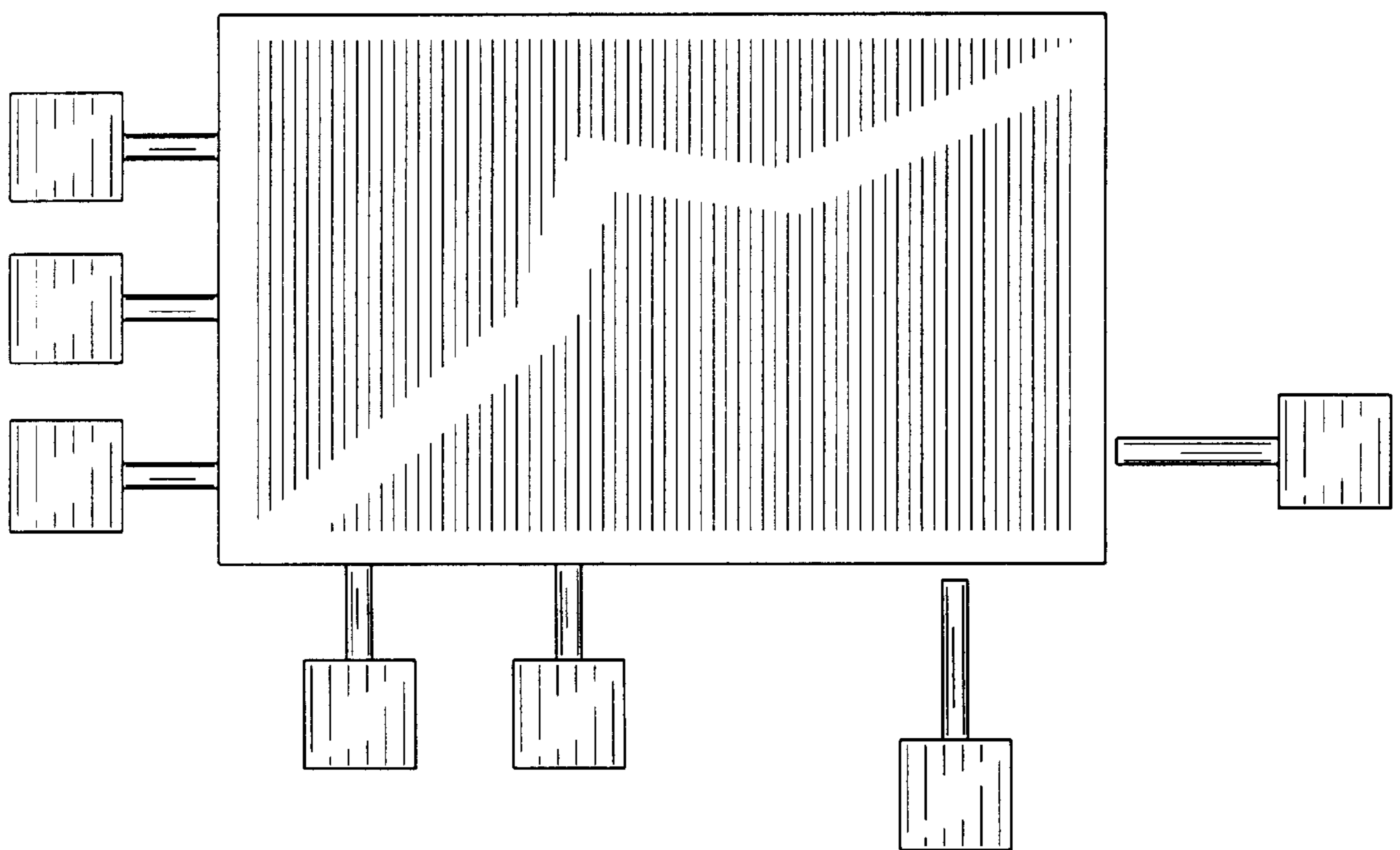

FIG. 6

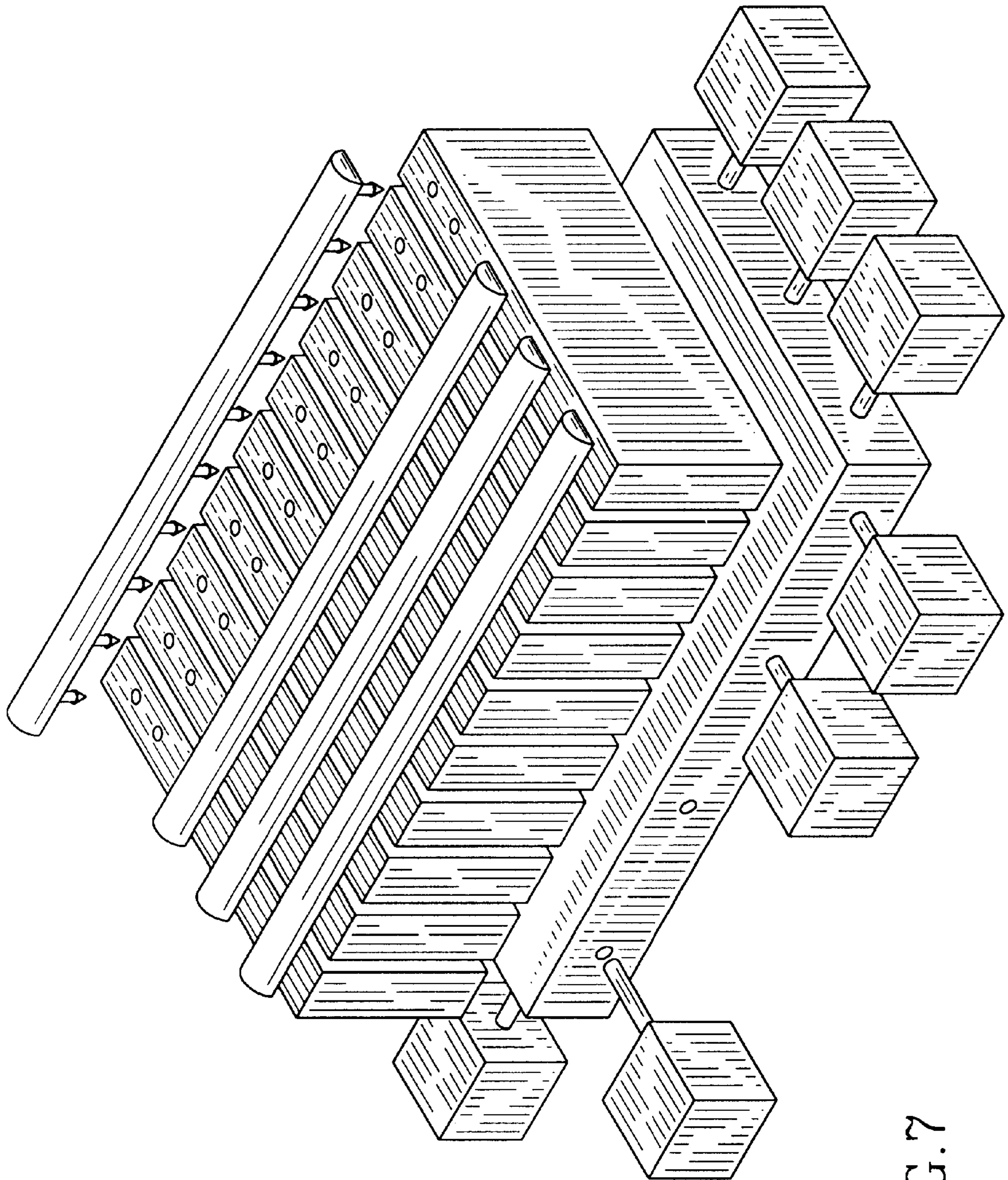

FIG. 7