



US00D457836S

(12) **United States Design Patent**
Kohama et al.

(10) **Patent No.:** **US D457,836 S**

(45) **Date of Patent:** **** May 28, 2002**

(54) **MOTORCYCLE**

D347,808 S * 6/1994 Heinrich et al. D12/110
D389,096 S * 1/1998 Tako et al. D12/110

(75) Inventors: **Mitsuyoshi Kohama; Hirotugu Ueno,**
both of Wako (JP)

* cited by examiner

(73) Assignee: **Honda Giken Kogyo Kabushiki**
Kaisha, Tokyo (JP)

Primary Examiner—Alan P. Douglas

Assistant Examiner—Linda Brooks

(**) Term: **14 Years**

(74) *Attorney, Agent, or Firm*—Birch, Stewart, Kolasch &
Birch, LLP

(21) Appl. No.: **29/146,942**

(22) Filed: **Aug. 21, 2001**

(57) **CLAIM**

The ornamental design for, a motorcycle, as shown and
described.

(30) **Foreign Application Priority Data**

Mar. 29, 2001 (JP) 2001-008970

DESCRIPTION

(51) **LOC (7) Cl.** **12-11**

(52) **U.S. Cl.** **D12/110**

(58) **Field of Search** D12/110; 180/219

FIG. 1 is a front perspective view of a motorcycle, showing
our new design;

FIG. 2 is a front elevation view thereof;

FIG. 3 is a rear elevation view thereof;

FIG. 4 is a top plan view thereof;

FIG. 5 is a bottom view of thereof;

FIG. 6 is a right side elevation view thereof, and,

FIG. 7 is a left side elevation view thereof.

(56) **References Cited**

U.S. PATENT DOCUMENTS

D333,641 S * 3/1993 Sakaguchi et al. D12/110

1 Claim, 7 Drawing Sheets

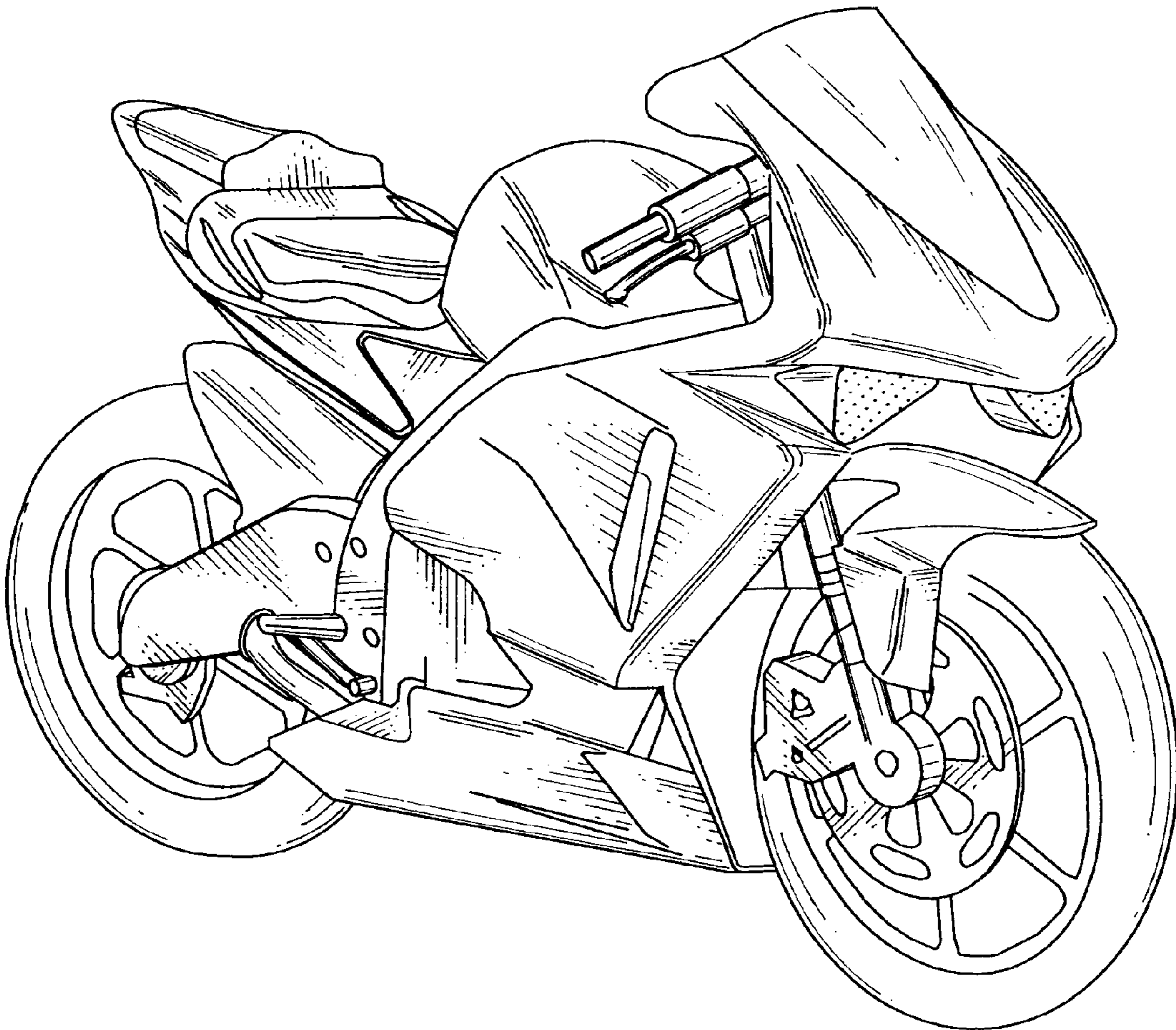

FIG. 1

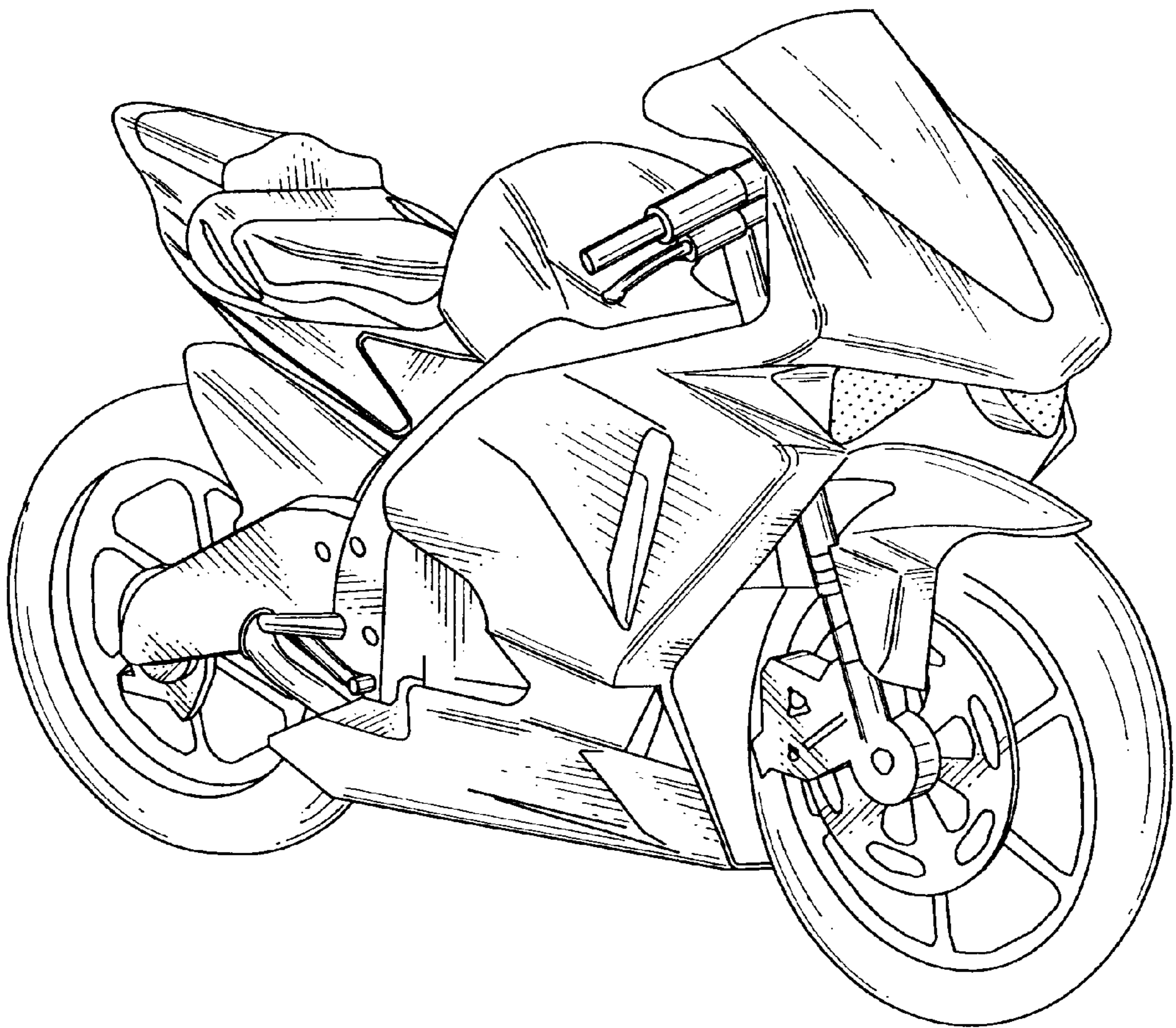

FIG. 2

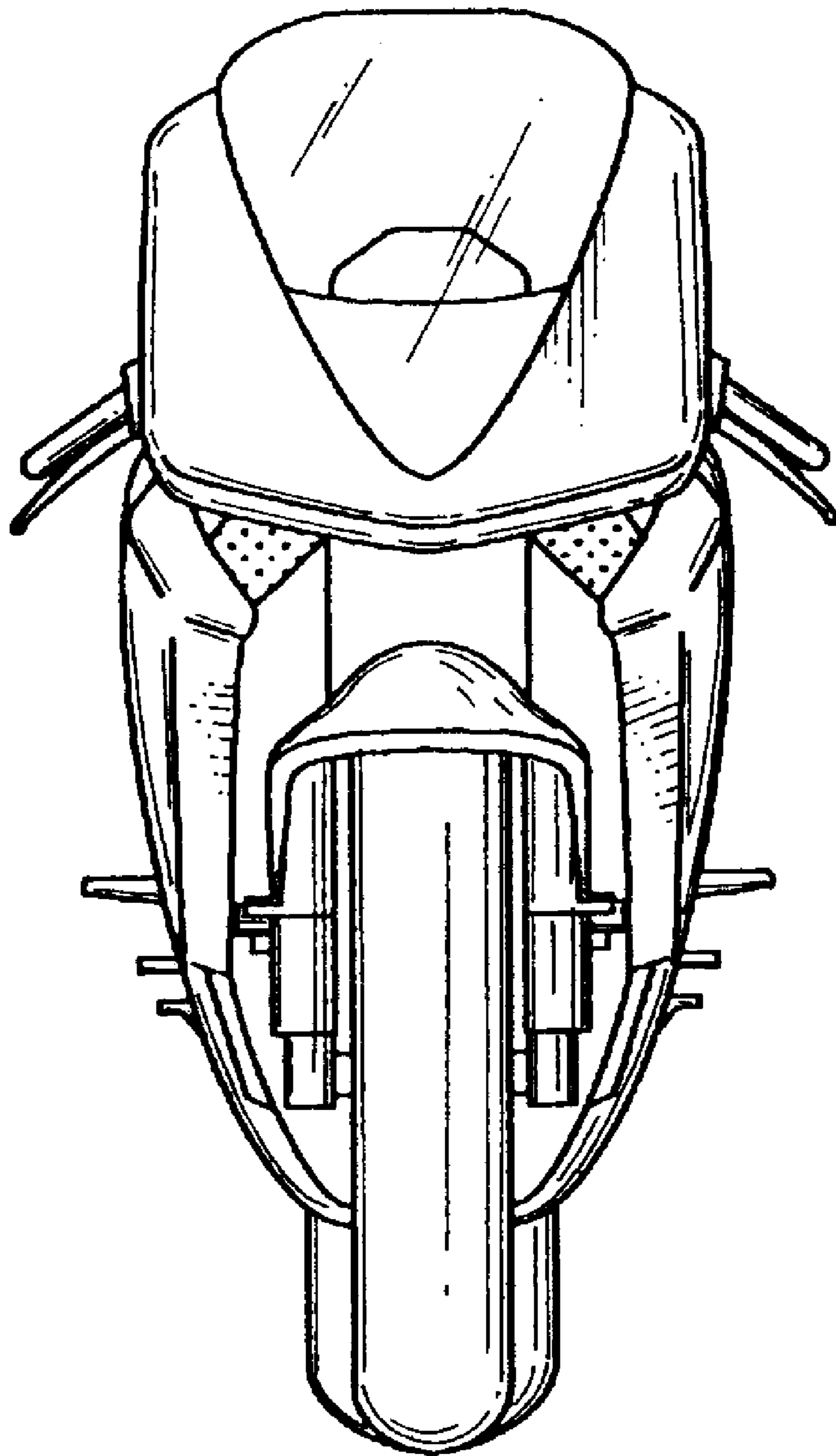

FIG. 3

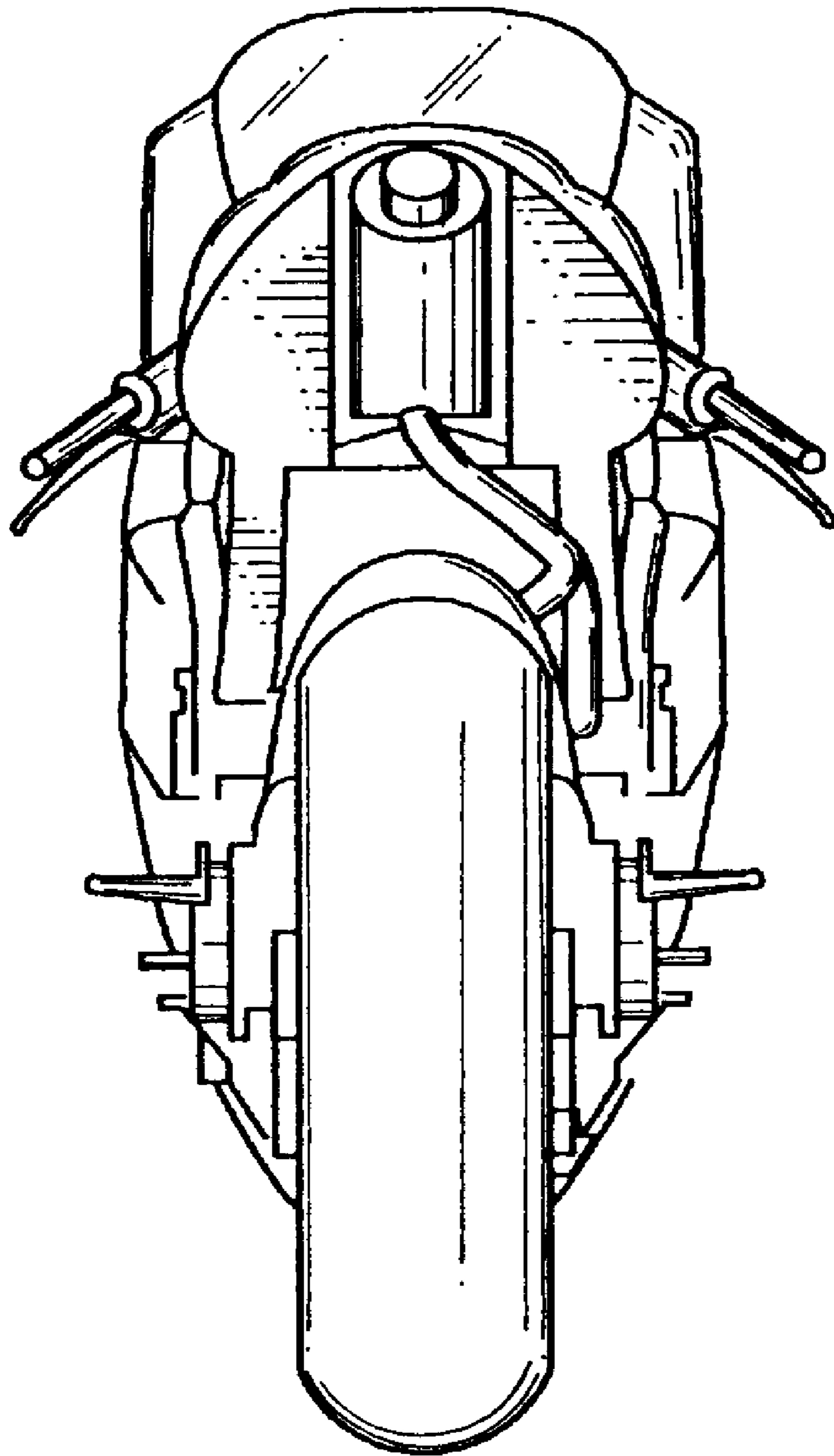

FIG. 4

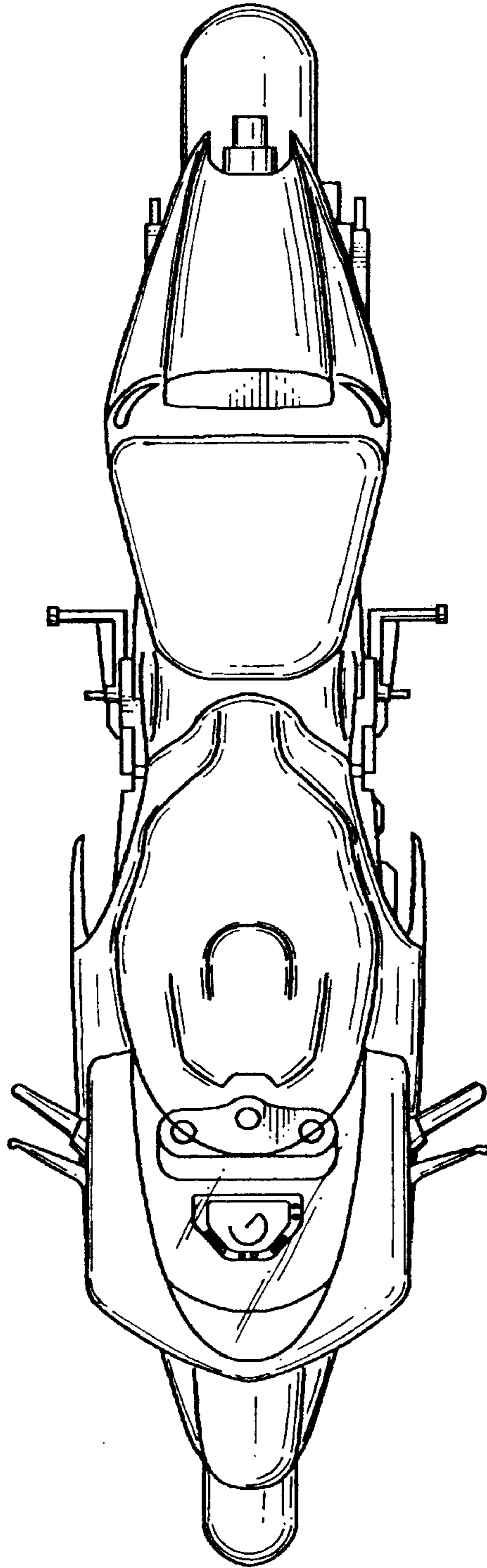

FIG. 5

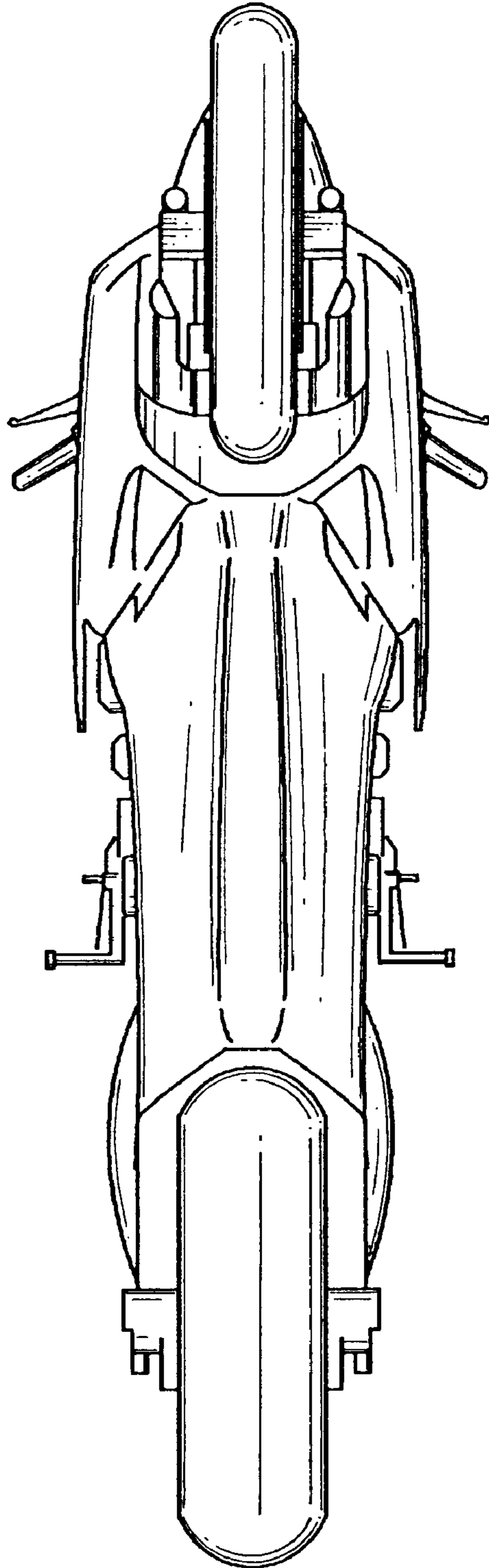

FIG. 6

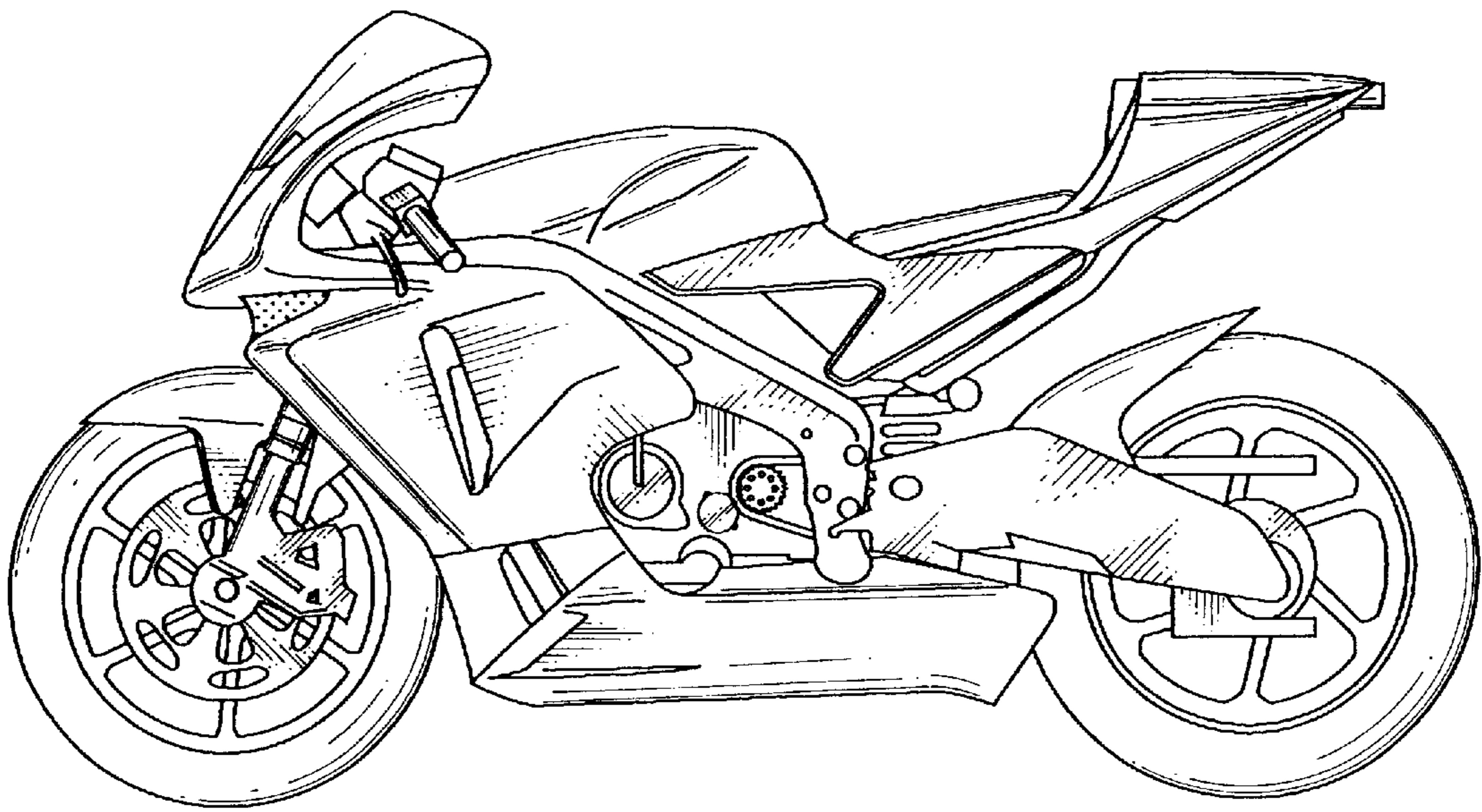

FIG. 7

